

MBR90200WT SCHOTTKY RECTIFIER

Applications:

- Switching power supply
- Converters
- Free-Wheeling diodes
- Reverse battery protection
- Center tap configuration

Features:

- 175°C T_J operation
- Center tap TO-247AD package
- Low forward voltage drop
- High purity, high temperature epoxy encapsulation for enhanced mechanical strength and moisture resistance
- High frequency operation
- Guard ring for enhanced ruggedness and long term reliability
- This is a Pb – Free Device
- All SMC parts are traceable to the wafer lot
- Additional testing can be offered upon request

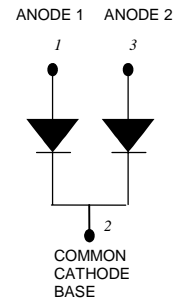

Mechanical Dimensions: In mm/Inches

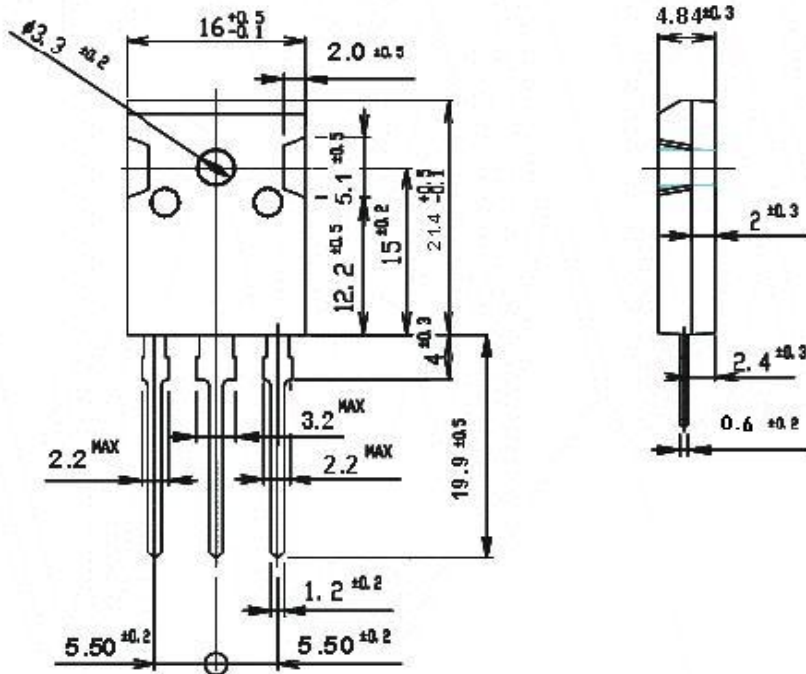

OPTION 1(SR)

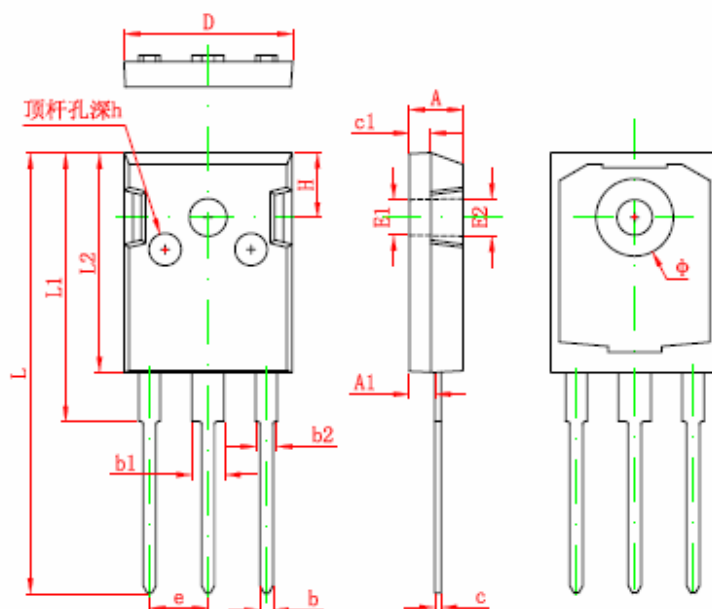

Symbol	Dimensions In Millimeters		Dimensions In Inches	
	Min	Max	Min	Max
A	4.850	5.150	0.191	0.200
A1	2.200	2.600	0.087	0.102
b	1.000	1.400	0.039	0.055
b1	2.800	3.200	0.110	0.126
b2	1.800	2.200	0.071	0.087
c	0.500	0.700	0.020	0.028
c1	1.900	2.100	0.075	0.083
D	15.450	15.750	0.608	0.620
E1	3.500 REF		0.138 REF	
E2	3.600 REF		0.142 REF	
L	40.900	41.300	1.610	1.626
L1	24.800	25.100	0.976	0.988
L2	20.300	20.600	0.799	0.811
Φ	7.100	7.300	0.280	0.287
e	5.450 TYP		0.215 TYP	
H	5.980 REF		0.235 REF	
h	0.000	0.300	0.000	0.012

OPTION 2(CJ)

TO-247AD

Technical Data
Data Sheet N0112, Rev. -

Green Products

Marking Diagram:

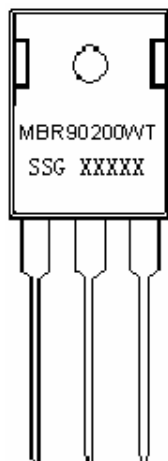

Where XXXXX is YYWWL

MBR = Device Type
90 = Forward Current (90A)
200 = Reverse Voltage (200V)
WT = Configuration
SSG = SSG
YY = Year
WW = Week
L = Lot Number

Cautions: Molding resin
Epoxy resin UL:94V-0

Ordering Information:

Device	Package	Shipping
MBR90200WT	TO-247AD (Pb-Free)	30pcs/ tube

For information on tape and reel specifications, including part orientation and tape sizes, please refer to our Tape and Reel Packaging Specification.

Maximum Ratings:

Characteristics	Symbol	Condition	Max.	Units
Peak Inverse Voltage	V_{RWM}	-	200	V
Max. Average Forward Current	$I_{F(AV)}$	rectangular $d=0.5$, @ $T_C = 145\text{ }^\circ\text{C}$	90	A
Max. Peak One Cycle Non-Repetitive Surge Current (per leg)	I_{FSM}	8.3 ms, half Sine pulse	860	A

Electrical Characteristics:

Characteristics	Symbol	Condition	Max.	Units
Max. Forward Voltage Drop(per leg)*	V_{F1}	@ 45A, Pulse, $T_J = 25\text{ }^\circ\text{C}$	0.96	V
	V_{F2}	@ 45A, Pulse, $T_J = 125\text{ }^\circ\text{C}$	0.86	V
Max. Reverse Current (per leg) *	I_{R1}	@ $V_R = \text{rated } V_R$ $T_J = 25\text{ }^\circ\text{C}$	1	mA
	I_{R2}	@ $V_R = \text{rated } V_R$ $T_J = 125\text{ }^\circ\text{C}$	25.0	mA
Max. Junction Capacitance (per leg)	C_T	@ $V_R = 5\text{V}$, $T_C = 25\text{ }^\circ\text{C}$ $f_{SIG} = 1\text{MHz}$	900	pF
Max. Voltage Rate of Change	dv/dt	-	10,000	V/ μs

* Pulse Width < 300 μs , Duty Cycle <2%

Thermal-Mechanical Specifications:

Characteristics	Symbol	Condition	Specification	Units
Max. Junction Temperature	T_J	-	-55 to +175	$^\circ\text{C}$
Max. Storage Temperature	T_{stg}	-	-55 to +150	$^\circ\text{C}$
Maximum Thermal Resistance Case to heatsink	R_{thCH}	DC operation	0.25	K/W
Approximate Weight	wt	-	6.7	g
Case Style	TO-247AD			

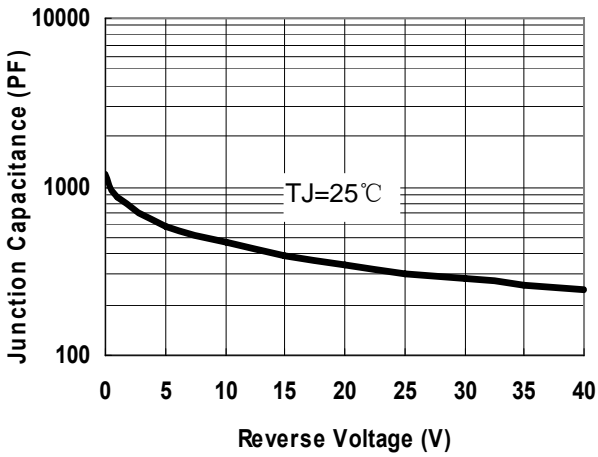

Fig.1-Typical Junction Capacitance

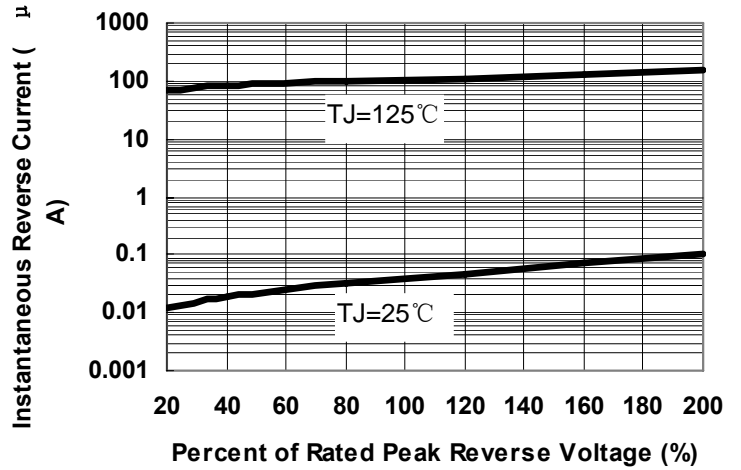

Fig.2-Typical Reverse Characteristics

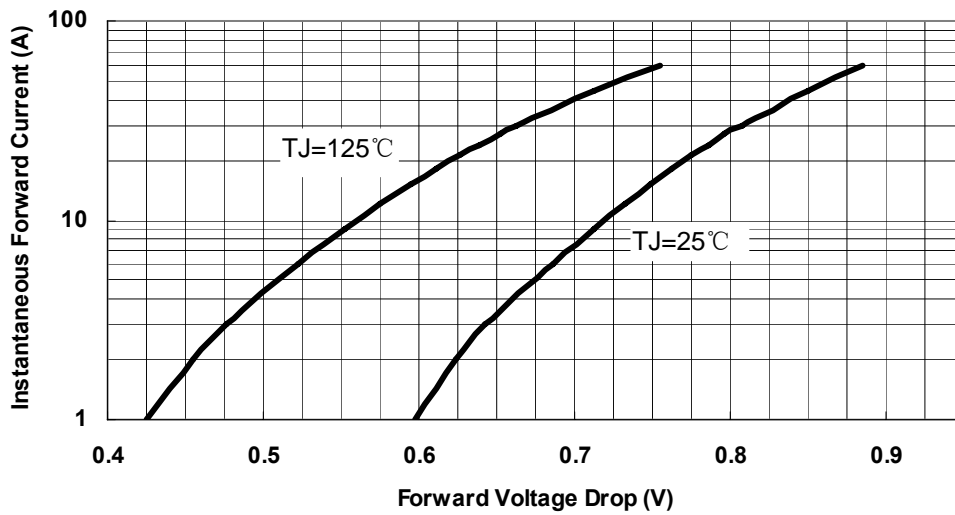

Fig.3-Typical Instantaneous Forward Voltage Characteristics

DISCLAIMER:

- 1- The information given herein, including the specifications and dimensions, is subject to change without prior notice to improve product characteristics. Before ordering, purchasers are advised to contact the SMC - Sangdest Microelectronics (Nanjing) Co., Ltd sales department for the latest version of the datasheet(s).
- 2- In cases where extremely high reliability is required (such as use in nuclear power control, aerospace and aviation, traffic equipment, medical equipment, and safety equipment), safety should be ensured by using semiconductor devices that feature assured safety or by means of users' fail-safe precautions or other arrangement.
- 3- In no event shall SMC - Sangdest Microelectronics (Nanjing) Co., Ltd be liable for any damages that may result from an accident or any other cause during operation of the user's units according to the datasheet(s). SMC - Sangdest Microelectronics (Nanjing) Co., Ltd assumes no responsibility for any intellectual property claims or any other problems that may result from applications of information, products or circuits described in the datasheets.
- 4- In no event shall SMC - Sangdest Microelectronics (Nanjing) Co., Ltd be liable for any failure in a semiconductor device or any secondary damage resulting from use at a value exceeding the absolute maximum rating.
- 5- No license is granted by the datasheet(s) under any patents or other rights of any third party or SMC - Sangdest Microelectronics (Nanjing) Co., Ltd.
- 6- The datasheet(s) may not be reproduced or duplicated, in any form, in whole or part, without the expressed written permission of SMC - Sangdest Microelectronics (Nanjing) Co., Ltd.
- 7- The products (technologies) described in the datasheet(s) are not to be provided to any party whose purpose in their application will hinder maintenance of international peace and safety nor are they to be applied to that purpose by their direct purchasers or any third party. When exporting these products (technologies), the necessary procedures are to be taken in accordance with related laws and regulations..