

Features

- Extremely high dv/dt capability
- Low Gate Charge Qg results in Simple Drive Requirement
- 100% avalanche tested
- Gate charge minimized
- Very low intrinsic capacitances
- Very good manufacturing repeatability

VDSS = 650V

ID = 8A

Rdson = 0.95Ω (typ.)

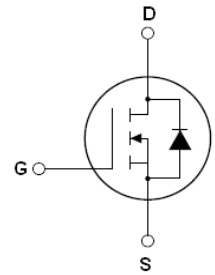

Description

The SSF8N65 is a new generation of high voltage N-Channel enhancement mode power MOSFETs and is obtained through an extreme optimization layout design, in addition to pushing on-resistance significantly down, special care is taken to ensure a very good dv/dt capability, provide superior switching performance, withstand high energy pulse in the avalanche, and increases packing density.

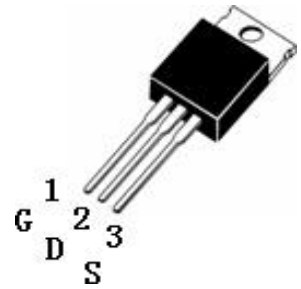

SSF8N65 TOP View (TO220)

Application

- High current, high speed switching
- Ideal for off-line power supply, adaptor, PFC

Absolute Maximum Ratings

	Parameter	Max.	Units
ID@Tc=25 °C	Continuous Drain Current, VGS@10V	8.2	A
ID@Tc=100°C	Continuous Drain Current, VGS@10V	5.5	
IDM	Pulsed Drain Current ①	32.8	
PD@TC=25°C	Power Dissipation	145	W
	Linear derating Factor	0.8	W/ C
VGS	Gate-to-Source Voltage	±30	V
EAS	Single Pulse Avalanche Energy ②	586	mJ
IAR	Avalanche Current ①	4	A
EAR	Repetitive Avalanche Energy ①	15	mJ
dv/dt	Peak Diode Recovery dv/dt ③	4.5	V/ns
TJ TSTG	Operating Junction and Storage Temperature Range	-55 to +150	°C

Thermal Resistance

	Parameter	Min.	Typ.	Max.	Units
RθJC	Junction-to-case	—	—	0.86	°C/W
RθCS	Case-to-Sink, Flat, Greased Surface	—	0.50	—	
RθJA	Junction-to-Ambient	—	—	62.5	

Electrical Characteristics @T_J=25 °C (unless otherwise specified)

	Parameter	Min.	Typ.	Max.	Units	Test Conditions
V(BR)DSS	Drain-to-Source Breakdown Voltage	650	—	—	V	V _{GS} =0V, I _D =250μA
Δ V(BR)DSS/ Δ T _J	Breakdown Voltage Temp.Coefficient	—	0.6	—	V/°C	Reference to 25°C, I _D =250μA
RDS(on)	Static Drain-to-Source On-resistance	—	0.95	1.2	Ω	V _{GS} =10V, I _D =3.8A ④
VGS(th)	Gate Threshold Voltage	2.0	—	4.0	V	V _{DS} =V _{GS} , I _D =250μA
gfs	Forward Transconductance	—	6.4	—	S	V _{DS} =40V, I _D =3.8A
IDSS	Drain-to-Source Leakage current	—	—	1	uA	V _{DS} =600V, V _{GS} =0V
		—	—	10		V _{DS} =480V, V _{GS} =0V, T _J =150°C
IGSS	Gate-to-Source Forward leakage	—	—	0.5	uA	V _{GS} =30V
	Gate-to-Source Reverse leakage	—	—	-0.5		V _{GS} =-30V
Qg	Total Gate Charge	—	28.5	15	nC	I _D =7.5A
Qgs	Gate-to-Source charge	—	7	—		V _{DS} =480V
Qgd	Gate-to-Drain("Miller") charge	—	14.6	—		V _{GS} =10V
td(on)	Turn-on Delay Time	—	29	70	nS	V _{DD} =300V I _D =7.5A R _G =25Ω
tr	Rise Time	—	78	160		
td(off)	Turn-Off Delay Time	—	65	130		
tf	Fall Time	—	60	128		
Ciss	Input Capacitance	—	1000	1350	pF	V _{GS} =0V
Coss	Output Capacitance	—	125	165		V _{DS} =25V
Crss	Reverse Transfer Capacitance	—	16	21		f=1.0MHZ

Source-Drain Ratings and Characteristics

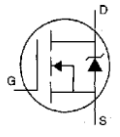
	Parameter	Min.	Typ.	Max.	Units	Test Conditions
IS	Continuous Source Current (Body Diode)	—	—	8.2	A	MOSFET symbol showing the integral reverse p-n junction diode. 
ISM	Pulsed Source Current (Body Diode) ①	—	—	32.8		
VSD	Diode Forward Voltage	—	—	1.3	V	T _J =25°C, I _S =7.2A, V _{GS} =0V ④
Trr	Reverse Recovery Time	—	300	—	nS	T _J =25°C, I _F =7.2A
Qrr	Reverse Recovery Charge	—	1.8	—	uC	di/dt=100A/μs ④

Notes:

- ① Repetitive rating; pulse width limited by maximum. junction temperature
- ② L = 23.5mH, I_{AS} =6.5A, V_{DD} = 50V, R_G = 25Ω Starting, T_J = 25°C
- ③ I_{SD} ≤4A, di/dt ≤200A/μs, V_{DD} ≤V(BR)DSS, T_J ≤25°C
- ④ Pulse width ≤300μs; duty cycle ≤2%

Typical Performance Characteristics

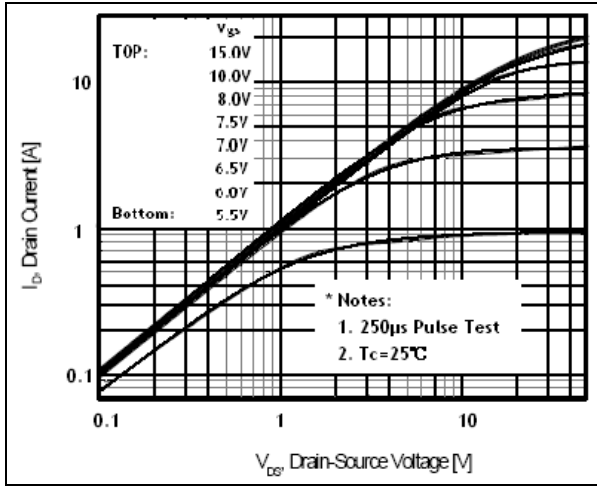

Figure 1 On-Region Characteristics

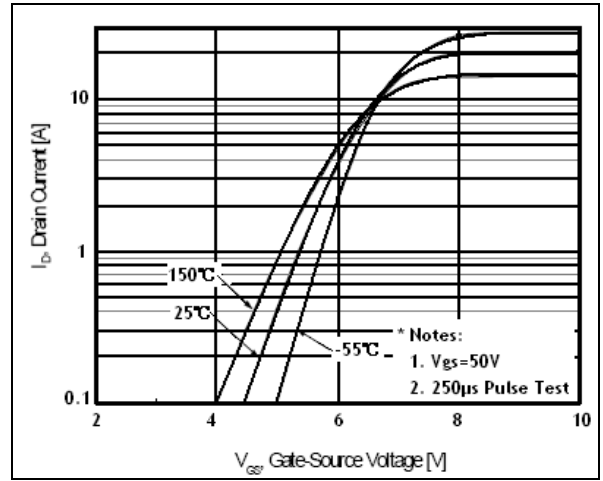

Figure 2 Transfer Characteristics

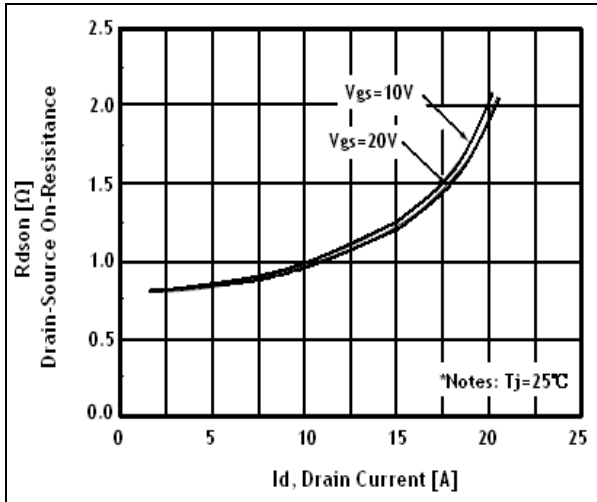

Figure 3 On-Resistance Variation vs. Drain Current and Gate Voltage

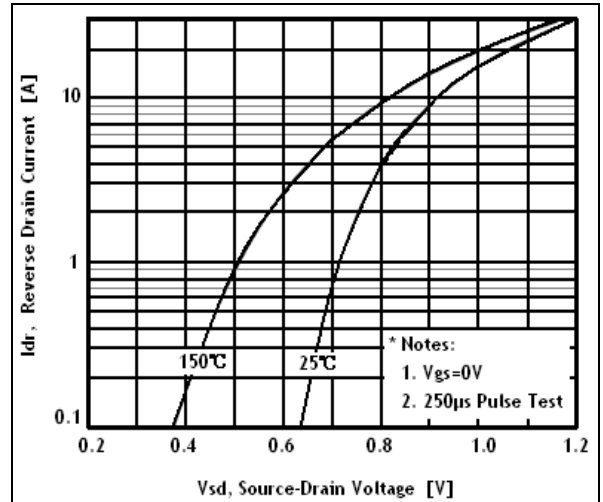

Figure 4 Body diode forward Voltage Variation vs. Source Current and temperature

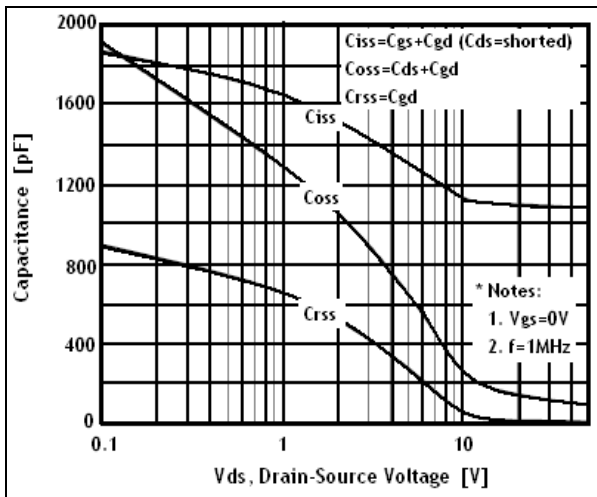

Figure 5 Capacitance Characteristics

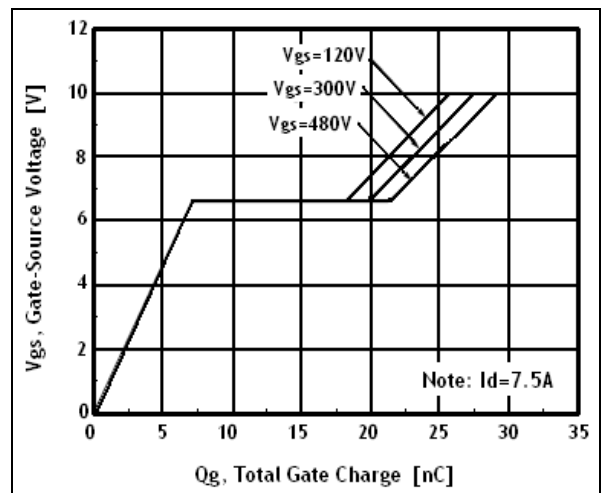

Figure 6 Gate Charge Characteristics

Typical Performance Characteristics

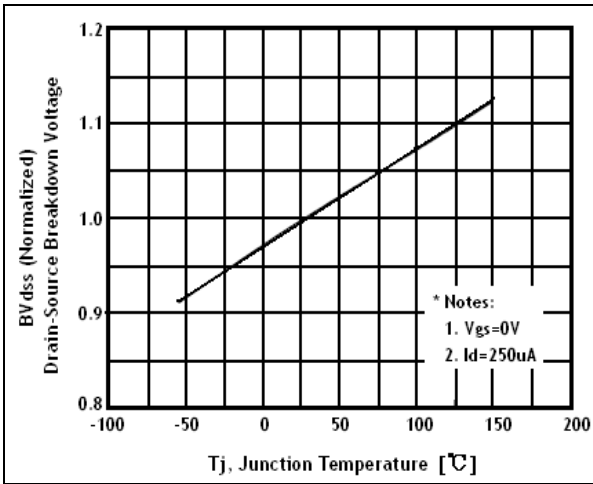

Figure 7 Breakdown Voltage Variation vs. Temperature

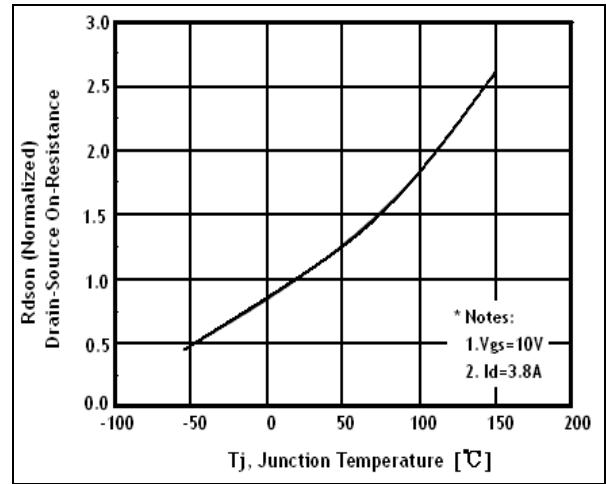

Figure 8 On-Resistance Variation vs. Temperature

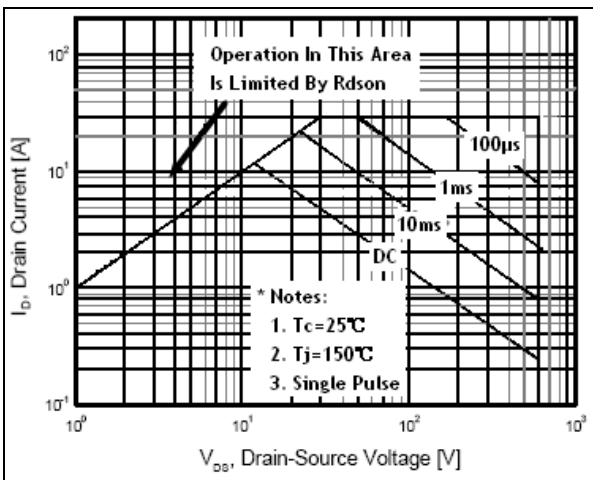

Figure 9 Maximum Safe Operation Area

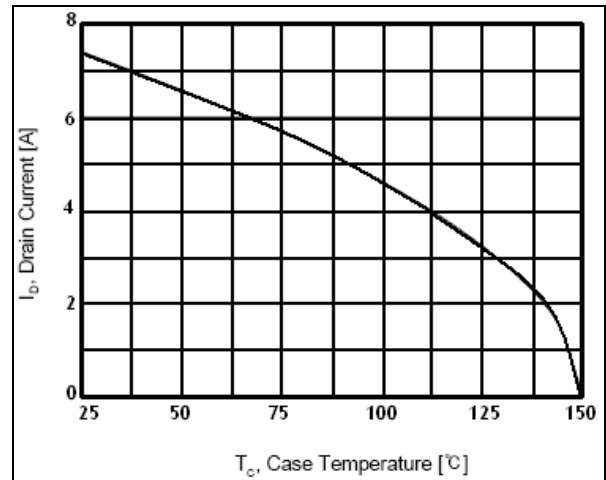

Figure 10 Maximum Drain Current vs. Case Temperature

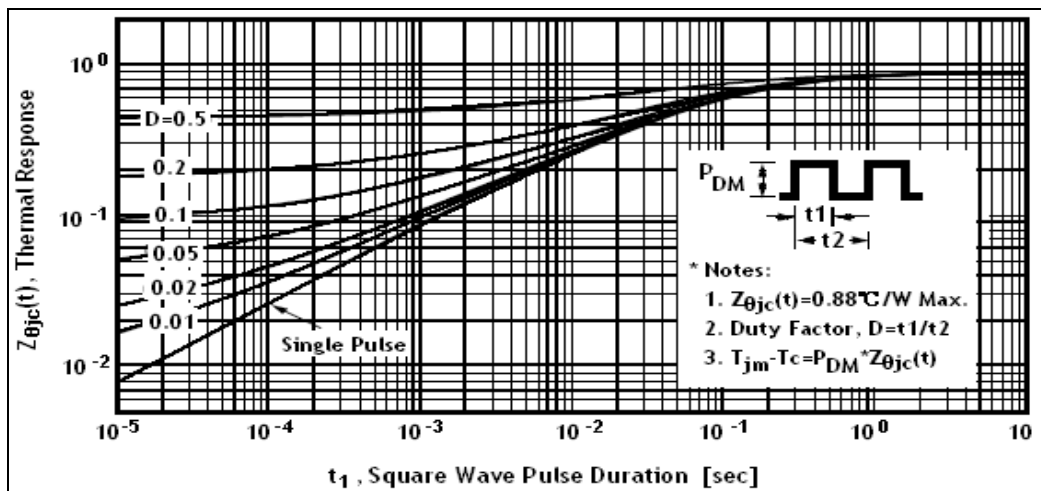
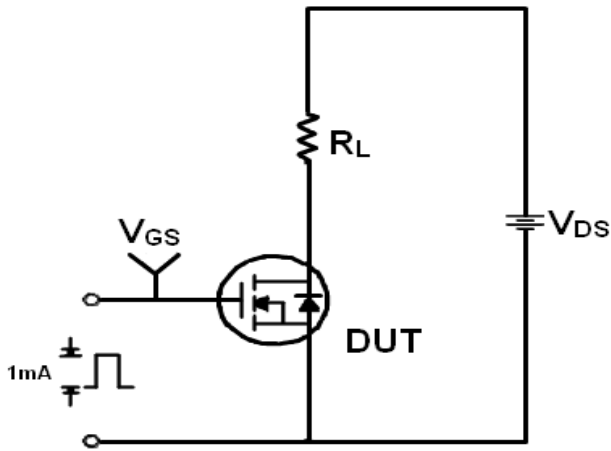
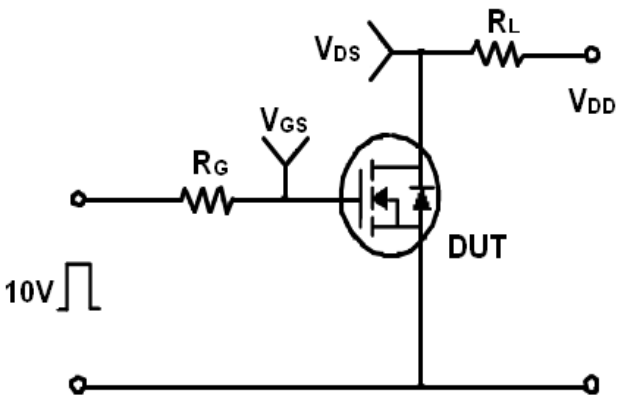

Figure 12 Transient Thermal Response Curve

Test Circuit and Waveform



Gate Charge Test Circuit & Waveform



Resistive Switching Test Circuit & Waveform

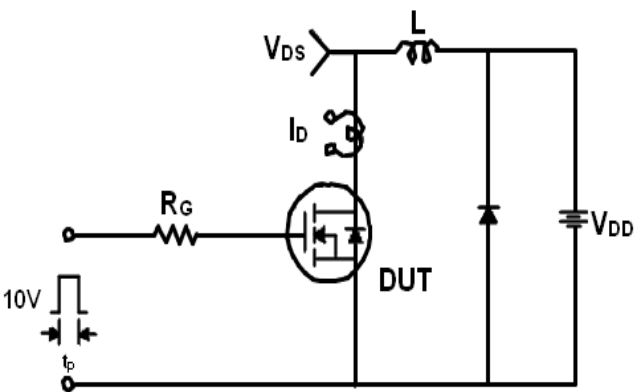

Unclamped Inductive Switching Test Circuit & Waveform

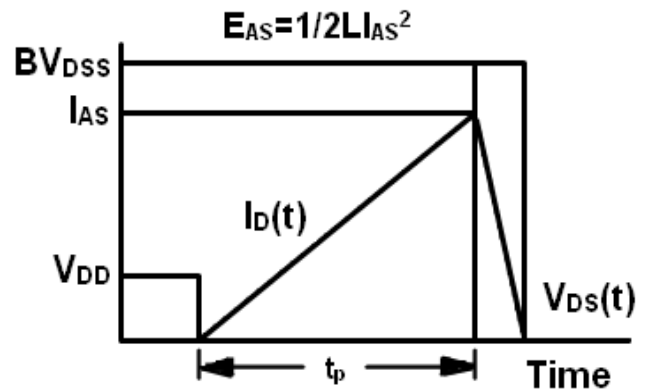
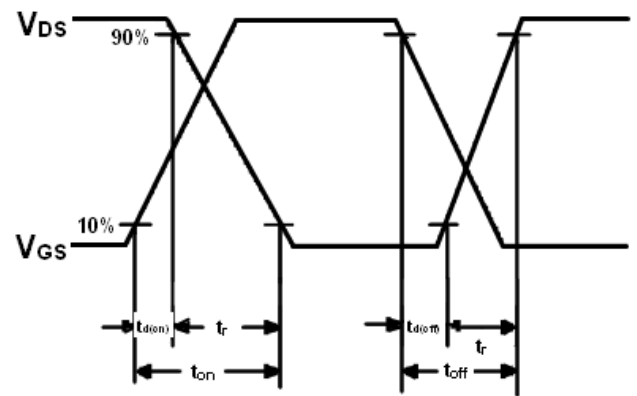
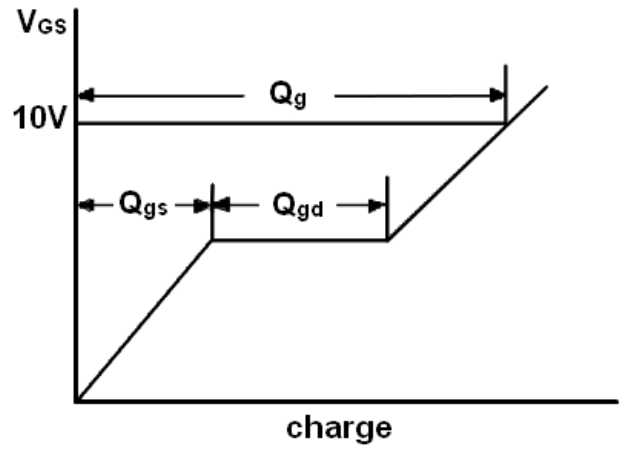

TO-220 MECHANICAL DATA:

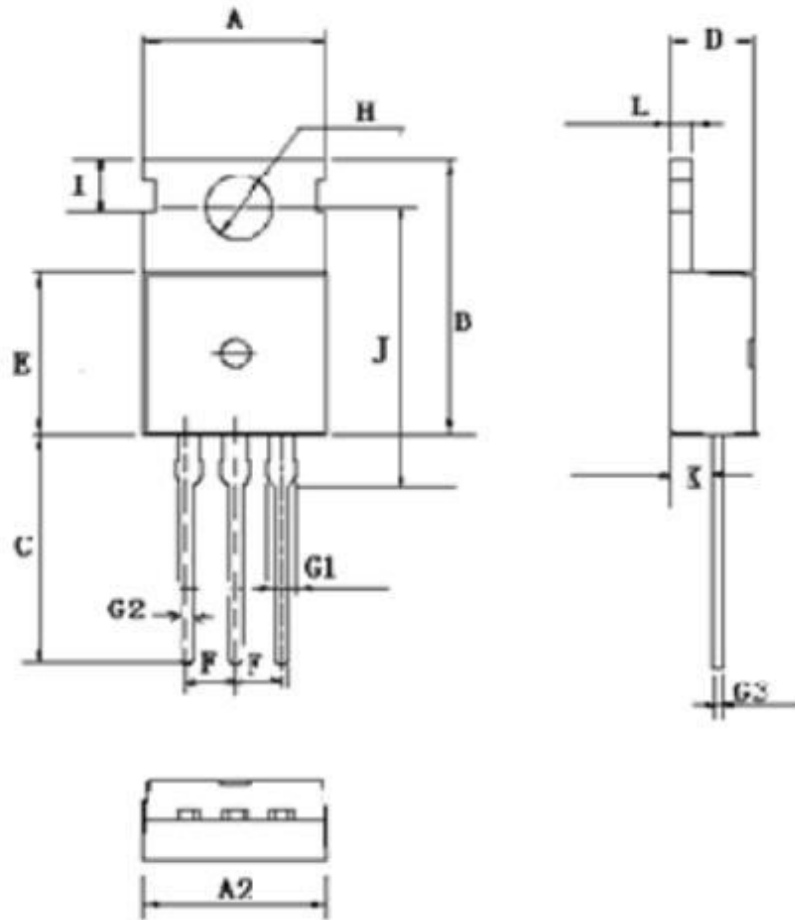

TO-220 3L

图形对应符号	产品外形尺寸
A(mm)	9.66~10.28
A2(mm)	9.80~10.20
B(mm)	15.6~15.8
C(mm)	12.70~14.27
D(mm)	4.30~4.70
E(mm)	8.59~9.40
F(mm)	2.54 (nom)
G1(mm)	1.42~1.62
G2(mm)	0.70~0.95
G3(mm)	0.45~0.60
H(mm) dia.	3.50~3.70
I(mm)	2.7~2.9
J(mm)	15.70~16.25
K(mm)	2.20~2.90
L(mm)	1.15~1.40
M(mm)	0.5