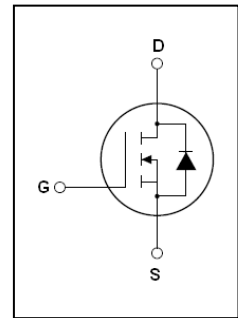

Main Product Characteristics:

V_{DSS}	55V
$R_{DS(on)}$	4.5mohm (Typ)
I_D	110A

SSF5508A TOP View (TO263)
Features and Benefits:

- Advanced trench MOSFET process technology
- Special designed for converters and power controls
- Ultra low on-resistance
- 175°C operating temperature
- High Avalanche capability and 100% tested

Description:

It utilizes the latest trench processing techniques to achieve the high cell density and reduces the on-resistance with high repetitive avalanche rating. These features combine to make this design an extremely efficient and reliable device for use in power switching application and a wide variety of other applications

Absolute max Rating:

Symbol	Parameter	Max.	Units
I_D @ TC = 25°C	Continuous Drain Current, VGS @ 10V ^①	110	A
I_D @ TC = 100°C	Continuous Drain Current, VGS @ 10V ^①	80	
IDM	Pulsed Drain Current ^②	440	
ISM	Pulsed Source Current.(Body Diode)	440	
PD @TC = 25°C	Power Dissipation ^③	205	W
	Linear derating factor	2	W/ C°
VDS	Drain-Source Voltage	55	V
VGS	Gate-to-Source Voltage	± 20	V
dv/dt	Peak diode recovery voltage	35	v/ns
EAS	Single Pulse Avalanche Energy @ L=0.3mH ^②	634	mJ
IAR	Avalanche Current @ L=0.3mH ^②	65	A
TJ TSTG	Operating Junction and Storage Temperature Range	-55 to + 175	°C

Thermal Resistance

Symbol	Characterizes	Value	Unit
$R_{\theta JC}$	Junction-to-case ^③	0.73	°C/W
$R_{\theta JA}$	Junction-to-ambient (t ≤ 10s) ^④	50	°C/W

Electrical Characterizes @ $T_A=25^{\circ}\text{C}$ unless otherwise specified

Symbol	Parameter	Min.	Typ.	Max.	Units	Conditions
BVDSS	Drain-to-Source breakdown voltage	55	60	—	V	VGS = 0V, ID = 250 μ A
RDS(on)	Static Drain-to-Source on-resistance	—	4.5	6	m Ω	VGS = 10V, ID = 20A
VGS(th)	Gate threshold voltage	2	3.1	4	V	VDS = VGS, ID = 250 μ A
IDSS	Drain-to-Source leakage current	—	—	1	μ A	VDS = 55V, VGS = 0V
		—	—	10		VDS = 55V, VGS = 0V, TJ = 150 $^{\circ}$ C
IGSS	Gate-to-Source forward leakage	—	—	100	nA	VGS = 20V
	Gate-to-Source reverse leakage	-100	—	—		VGS = -20V
Qg	Total gate charge	—	125	147	nC	ID=30A VDD=30V VGS=10V
Qgs	Gate-to-Source charge	—	24	30		
Qgd	Gate-to-Drain("Miller") charge	—	49	61		
Qg(th)	Gate charge at shreshold	—	16	20		
Vplateau	gate plateau voltage	—	4.7	6	V	
td(on)	Turn-on delay time	—	20	—	ns	VDD=30V ID=2A ,RL=15 Ω RG=2.5 Ω VGS=10V
tr	Rise time	—	19	—		
td(off)	Turn-Off delay time	—	70	—		
tf	Fall time	—	30	—		
Ciss	Input capacitance	—	5607	—	pF	VGS = 0V, VDS = 25V, f = 1.0MHz
Coss	Output capacitance	—	463	—		
Crss	Reverse transfer capacitance	—	454	—		

Source-Drain Ratings and Characteristics

Symbol	Parameter	Min.	Typ.	Max.	Units	Conditions
IS	Maximum Body-Diode Continuous Curren	—	110	—	A	
VSD	Diode Forward Voltage	—	0.77	1	V	IS=40A, VGS=0V
Trr	Reverse Recovery Time	—	36	—	ns	TJ = 25 $^{\circ}$ C, IF =68A, ,
Qrr	Reverse Recovery Charge	—	57	—	nC	di/dt = 100A/ μ s
ton	Forward Turn-on Time	Intrinsic turn-on time is negligible (turn-on is dominated by LS+LD)				

Typical electrical and thermal characteristics

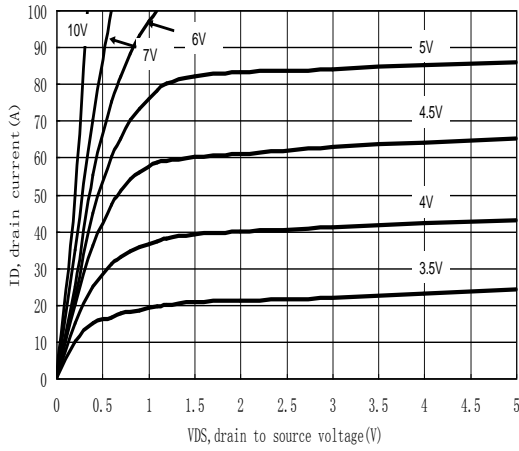
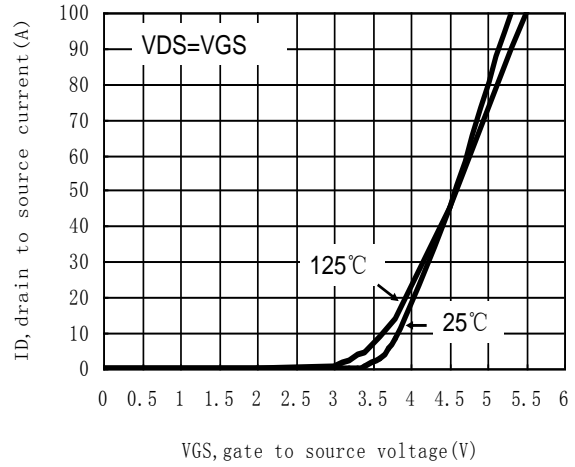
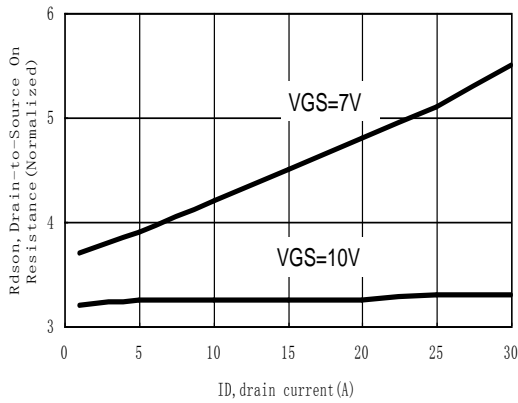
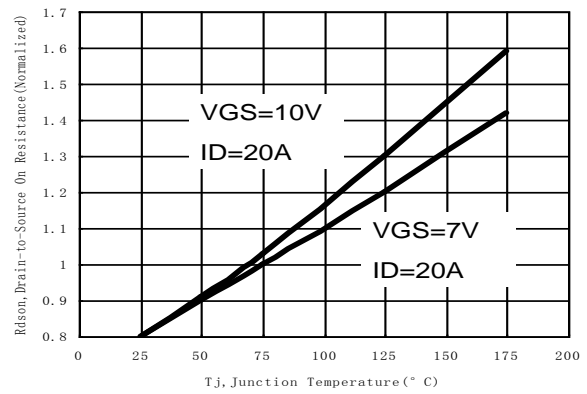
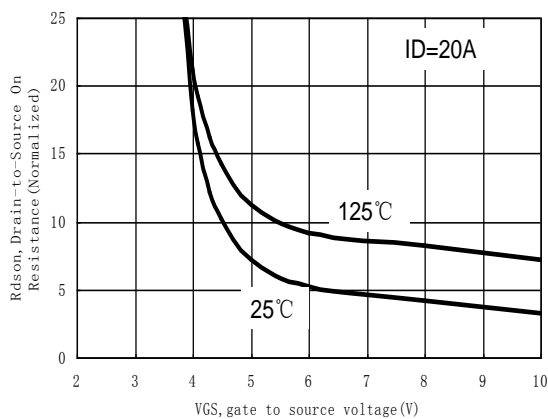
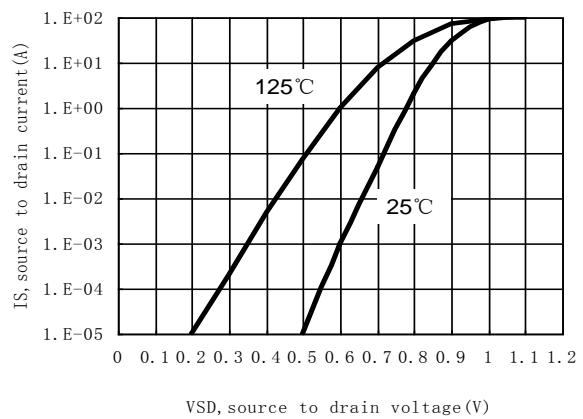
Figure 1: Typical Output Characteristics

Figure 2: Typical Transfer Characteristics

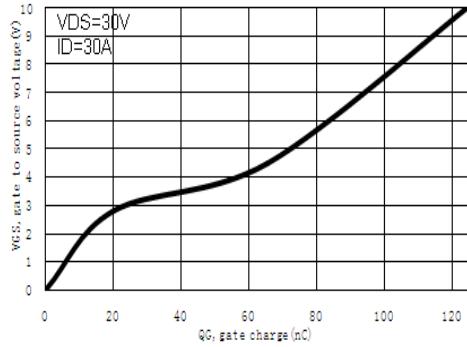
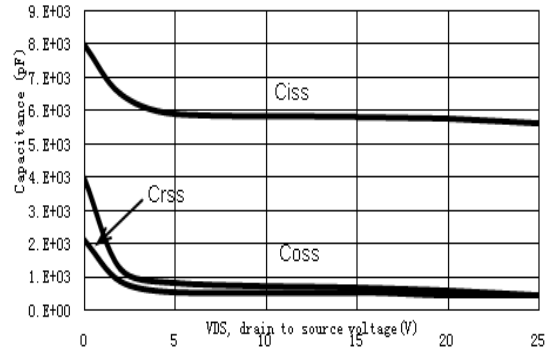
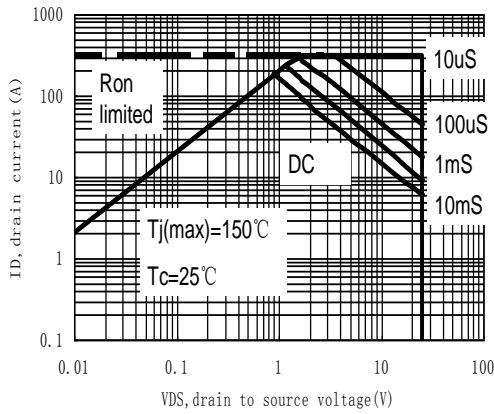
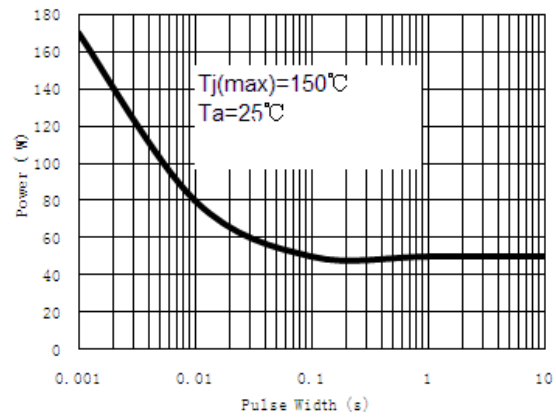
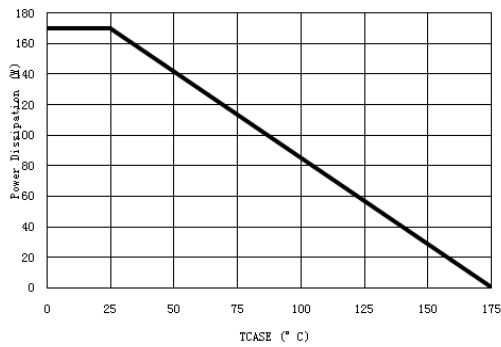
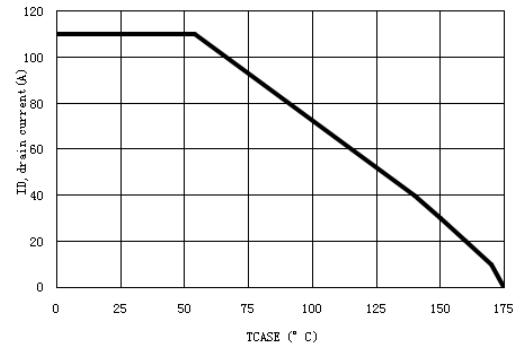
Figure 3: On-Resistance vs. Drain Current and Gate Voltage

Figure 4: On-Resistance vs. Junction Temperature

Figure 5: On-Resistance vs. Gate-Source Voltage

Figure 6: Body-Diode Characteristics

Typical electrical and thermal characteristics

Figure 7: Gate-Charge Characteristics Figure

Figure 8: Capacitance Characteristics

Figure 9: Maximum Forward Biased Safe Operating Area (SOA)

Figure 10: Single Pulse Power Rating Junction-to-Case (JC)

Figure 11: Power De-rating (JC)

Figure 12: Current De-rating (JC)

Typical electrical and thermal characteristics

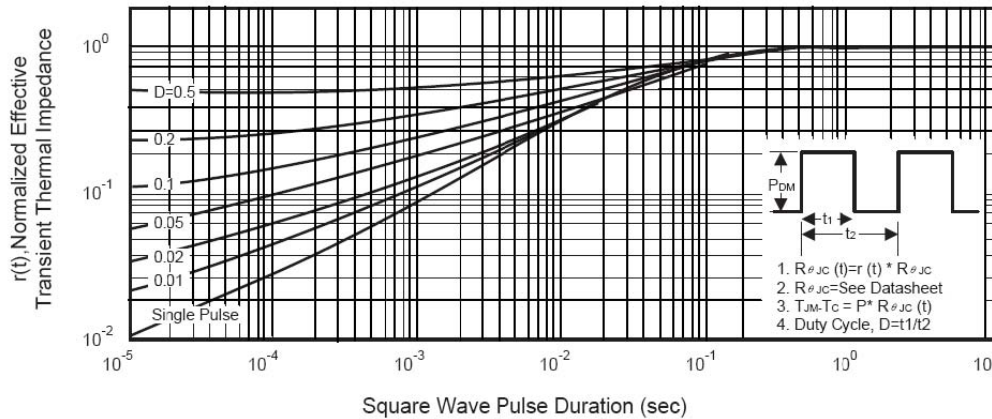
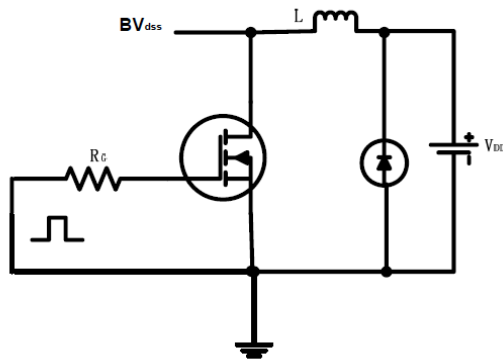
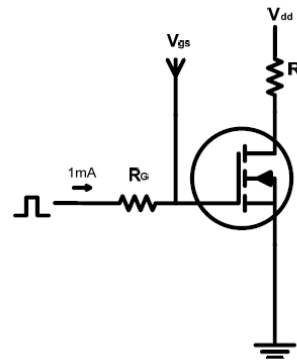

Figure 13: Transient Thermal Impedance Curve

EAS test circuits:



Gate charge test circuit:



Switch Time Test Circuit:

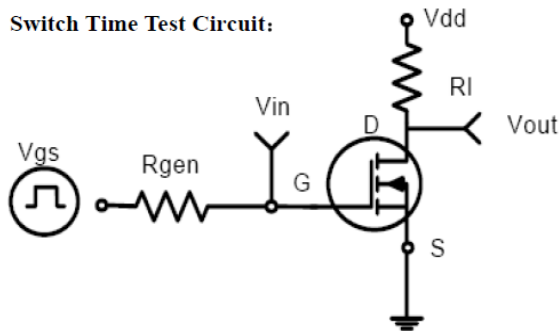

Switch Waveforms

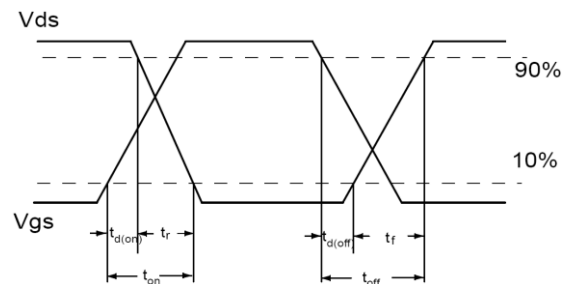

Notes: ① The maximum current rating is limited by bond-wires.

② Repetitive rating; pulse width limited by max. junction temperature. EAS starting, $I_D=65A$.

③ The power dissipation PD is based on max. junction temperature, using junction-to-case thermal resistance.

④ The value of $R_{\theta JA}$ is measured with the device mounted on 1in 2 FR-4 board with 2oz. Copper, in a still air environment with $T_A = 25^\circ C$

TO-263 MECHANICAL DATA:

DIM.	mm.			inch		
	MIN.	TYP	MAX.	MIN.	TYP.	MAX.
A	4.4		4.6	0.173		0.181
A1	2.49		2.69	0.098		0.106
A2	0.03		0.23	0.001		0.009
B	0.7		0.93	0.027		0.036
B2	1.14		1.7	0.044		0.067
C	0.45		0.6	0.017		0.023
C2	1.23		1.36	0.048		0.053
D	8.95		9.35	0.352		0.368
D1		8			0.315	
E	10		10.4	0.393		
E1		8.5			0.334	
G	4.88		5.28	0.192		0.208
L	15		15.85	0.590		0.625
L2	1.27		1.4	0.050		0.055
L3	1.4		1.75	0.055		0.068
M	2.4		3.2	0.094		0.126
R		0.4			0.015	
V2	0°		4°			

