

Features

- 1) Built-in bias resistors enable the configuration of an inverter circuit without connecting external input resistors (see equivalent circuit).
- 2) The bias resistors consist of thin-film resistors with complete isolation to allow negative biasing of the input. They also have the advantage of almost completely eliminating parasitic effects.
- 3) Only the on/off conditions need to be set for operation, making device design easy

●Equivalent circuit

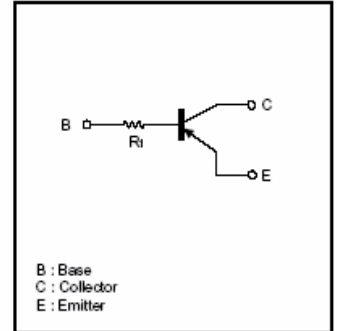

PIN CONNENCTIONS AND MARKING

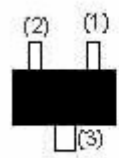
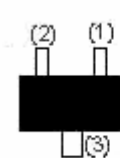
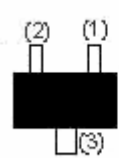
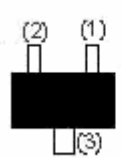
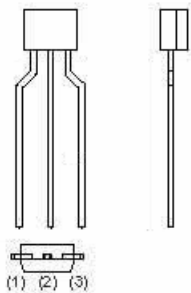
<p>DTA144TE</p>  <p>(1) Base (2) Emitter (3) Collector</p> <p>SOT-523 Abbreviated symbol: 96</p>	<p>DTA144TUA</p>  <p>(1) Base (2) Emitter (3) Collector</p> <p>SOT-323 Abbreviated symbol: 96</p>
<p>DTA144TKA</p>  <p>(1) Base (2) Emitter (3) Collector</p> <p>SOT-23-3L Abbreviated symbol: 96</p>	<p>DTA144TCA</p>  <p>(1) Base (2) Emitter (3) Collector</p> <p>SOT-23 Abbreviated symbol: 96</p>
<p>DTA144TSA</p>  <p>(1) Emitter (2) Collector (3) Base</p> <p>TO-92S</p>	

MAXIMUM RATINGS* $T_A=25^\circ\text{C}$ unless otherwise noted

Symbol	Parameter	LIMITS(DTA144T□)					Units
		E	UA	KA	CA	SA	
V_{CBO}	Collector-Base Voltage	-50					V
V_{CEO}	Collector-Emitter Voltage	-50					V
V_{EBO}	Emitter-Base Voltage	-5					V
I_C	Collector Current -Continuous	-100					mA
P_C	Collector Dissipation	150	200			300	mW
T_j	Junction temperature	150					$^\circ\text{C}$
T_J, T_{stg}	Junction and Storage Temperature	-55~+150					$^\circ\text{C}$

ELECTRICAL CHARACTERISTICS ($T_{amb}=25^\circ\text{C}$ unless otherwise specified)

Parameter	Symbol	Test conditions	MIN	TYP	MAX	UNIT
Collector-base breakdown voltage	$V_{(BR)CBO}$	$I_C=-50\mu\text{A}, I_E=0$	-50			V
Collector-emitter breakdown voltage	$V_{(BR)CEO}$	$I_C=-1\text{mA}, I_B=0$	-50			V
Emitter-base breakdown voltage	$V_{(BR)EBO}$	$I_E=-50\mu\text{A}, I_C=0$	-5			V
Collector cut-off current	I_{CBO}	$V_{CB}=-50\text{V}, I_E=0$			-0.5	μA
Emitter cut-off current	I_{EBO}	$V_{EB}=-4\text{V}, I_C=0$			-0.5	μA
DC current gain	h_{FE}	$V_{CE}=-5\text{V}, I_C=-1\text{mA}$	100	300	600	
Collector-emitter saturation voltage	$V_{CE(sat)}$	$I_C=-5\text{mA}, I_B=-0.5\text{mA}$			-0.3	V
Transition frequency	f_T	$V_{CE}=-10\text{V}, I_E=5\text{mA}, f=100\text{MHz}$		250		MHz
Input resistor	R1		32.9	47	61.1	$k\Omega$

Typical Characteristics

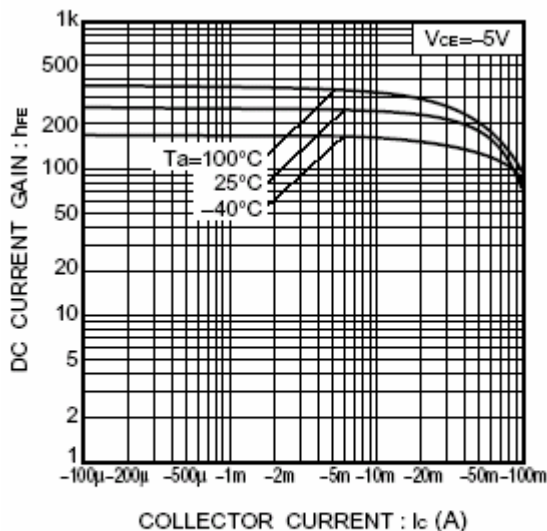

Fig.1 DC current gain vs.collector current

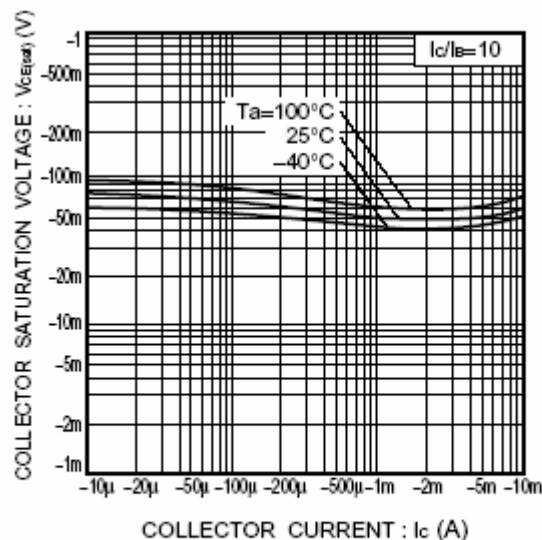

Fig.2 Collector-emitter saturation voltage vs.collector current