

MBRM130LT1G, NRVBM130LT1G, MBRM130LT3G, NRVBM130LT3G

Surface Mount Schottky Power Rectifier

POWERMITE® Power Surface Mount Package

The SchottkyPOWERMITE® employs the Schottky Barrier principle with a barrier metal and epitaxial construction that produces optimal forward voltage drop–reverse current tradeoff. The advanced packaging techniques provide for a highly efficient micro miniature, space saving surface mount Rectifier. With its unique heatsink design, thePOWERMITE® has the same thermal performance as the SMA while being 50% smaller in footprint area, and delivering one of the lowest height profiles, < 1.1 mm in the industry. Because of its small size, it is ideal for use in portable and battery powered products such as cellular and cordless phones, chargers, notebook computers, printers, PDAs and PCMCIA cards. Typical applications are AC–DC and DC–DC converters, reverse battery protection, and “ORing” of multiple supply voltages and any other application where performance and size are critical.

Features

- Low Profile – Maximum Height of 1.1 mm
- Small Footprint – Footprint Area of 8.45 mm²
- Low V_F Provides Higher Efficiency and Extends Battery Life
- Supplied in 12 mm Tape and Reel
- Low Thermal Resistance with Direct Thermal Path of Die on Exposed Cathode Heat Sink
- ESD Ratings:
 - ◆ Human Body Model = 3B (> 16 kV)
 - ◆ Machine Model = C (> 400 V)
- AEC–Q101 Qualified and PPAP Capable
- NRVB Prefix for Automotive and Other Applications Requiring Unique Site and Control Change Requirements
- All Packages are Pb–Free*

Mechanical Characteristics:

- POWERMITE® is JEDEC Registered as D0–216AA
- Case: Molded Epoxy
- Epoxy Meets UL 94 V–0 @ 0.125 in
- Weight: 16.3 mg (Approximately)
- Lead and Mounting Surface Temperature for Soldering Purposes: 260°C Maximum for 10 Seconds

*For additional information on our Pb–Free strategy and soldering details, please download the ON Semiconductor Soldering and Mounting Techniques Reference Manual, SOLDERRM/D.



ON Semiconductor®

<http://onsemi.com>

SCHOTTKY BARRIER RECTIFIER 1.0 AMPERES, 30 VOLTS

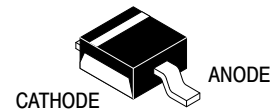

POWERMITE
CASE 457
PLASTIC

MARKING DIAGRAM

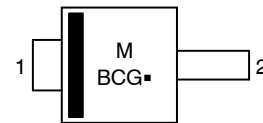

M = Date Code
BCG = Device Code
■ = Pb–Free Package

ORDERING INFORMATION

Device	Package	Shipping†
MBRM130LT1G	POWERMITE (Pb–Free)	3,000 / Tape & Reel
NRVBM130LT1G	POWERMITE (Pb–Free)	3,000 / Tape & Reel
MBRM130LT3G	POWERMITE (Pb–Free)	12,000 / Tape & Reel
NRVBM130LT3G	POWERMITE (Pb–Free)	12,000 / Tape & Reel

†For information on tape and reel specifications, including part orientation and tape sizes, please refer to our Tape and Reel Packaging Specifications Brochure, BRD8011/D.

MBRM130LT1G, NRVBM130LT1G, MBRM130LT3G, NRVBM130LT3G

MAXIMUM RATINGS

Rating	Symbol	Value	Unit
Peak Repetitive Reverse Voltage Working Peak Reverse Voltage DC Blocking Voltage	V_{RRM} V_{RWM} V_R	30	V
Average Rectified Forward Current (At Rated V_R , $T_C = 135^\circ\text{C}$)	I_O	1.0	A
Peak Repetitive Forward Current (At Rated V_R , Square Wave, 100 kHz, $T_C = 135^\circ\text{C}$)	I_{FRM}	2.0	A
Non-Repetitive Peak Surge Current (Non-Repetitive peak surge current, halfwave, single phase, 60 Hz)	I_{FSM}	50	A
Storage Temperature	T_{stg}	-55 to 150	$^\circ\text{C}$
Operating Junction Temperature	T_J	-55 to 125	$^\circ\text{C}$
Voltage Rate of Change (Rated V_R , $T_J = 25^\circ\text{C}$)	dv/dt	10,000	V/ μs

Stresses exceeding Maximum Ratings may damage the device. Maximum Ratings are stress ratings only. Functional operation above the Recommended Operating Conditions is not implied. Extended exposure to stresses above the Recommended Operating Conditions may affect device reliability.

THERMAL CHARACTERISTICS

Characteristic	Symbol	Value	Unit
Thermal Resistance, Junction-to-Lead (Anode) (Note 1)	R_{tjl}	35	$^\circ\text{C}/\text{W}$
Thermal Resistance, Junction-to-Tab (Cathode) (Note 1)	R_{tjtab}	23	
Thermal Resistance, Junction-to-Ambient (Note 1)	R_{tja}	277	

1. Mounted with minimum recommended pad size, PC Board FR4, See Figures 9 & 10

ELECTRICAL CHARACTERISTICS

Characteristic	Symbol	Value		Unit
Maximum Instantaneous Forward Voltage (Note 2), See Figure 2 ($I_F = 0.1\text{ A}$) ($I_F = 1.0\text{ A}$) ($I_F = 3.0\text{ A}$)	V_F	$T_J = 25^\circ\text{C}$	$T_J = 85^\circ\text{C}$	V
		0.30	0.20	
		0.38	0.33	
Maximum Instantaneous Reverse Current (Note 2), See Figure 4 ($V_R = 30\text{ V}$) ($V_R = 20\text{ V}$) ($V_R = 10\text{ V}$)	I_R	$T_J = 25^\circ\text{C}$	$T_J = 85^\circ\text{C}$	mA
		0.41	11	
		0.13	5.3	
		0.05	3.2	

2. Pulse Test: Pulse Width $\leq 250\ \mu\text{s}$, Duty Cycle $\leq 2\%$

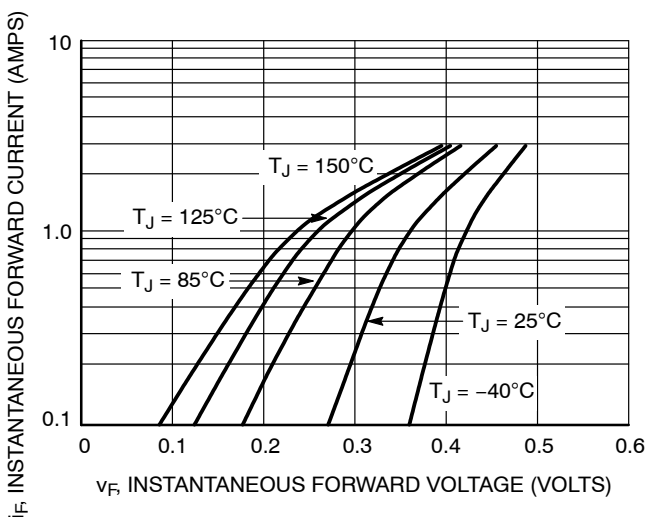

Figure 1. Typical Forward Voltage

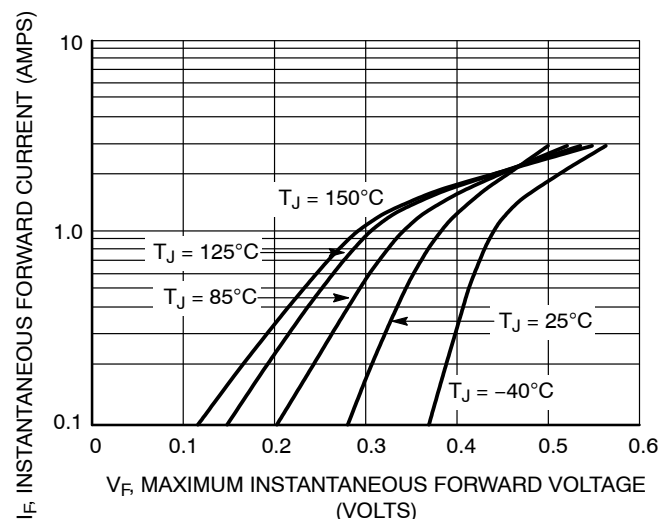

Figure 2. Maximum Forward Voltage

MBRM130LT1G, NRVBM130LT1G, MBRM130LT3G, NRVBM130LT3G

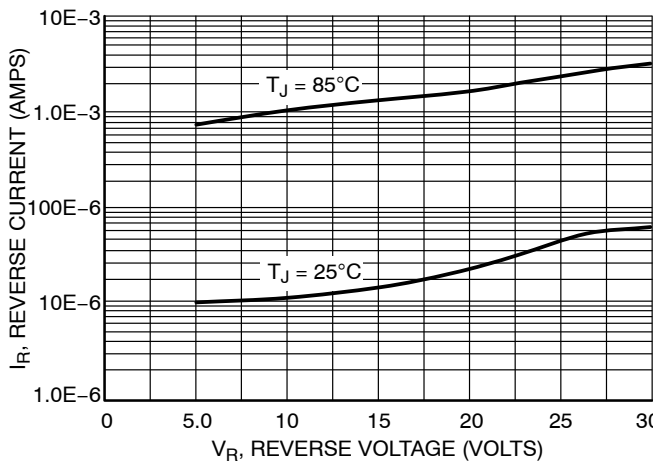

Figure 3. Typical Reverse Current

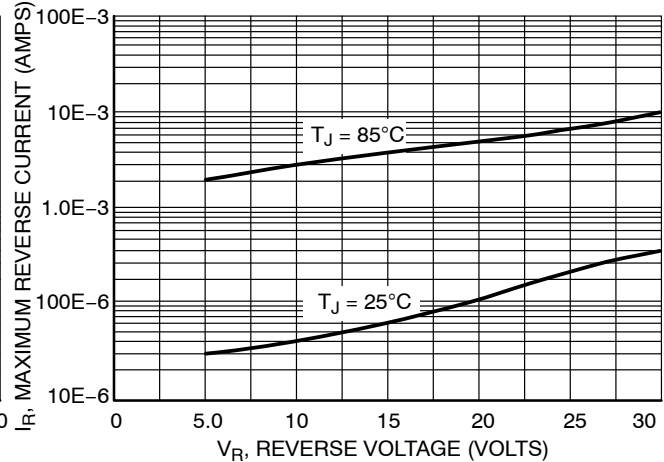

Figure 4. Maximum Reverse Current

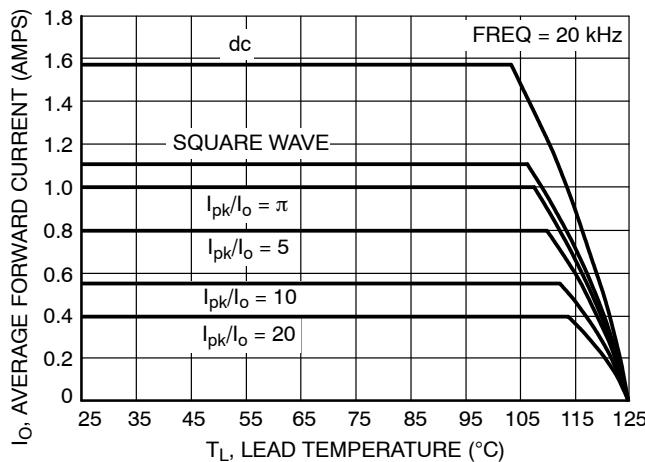

Figure 5. Current Derating

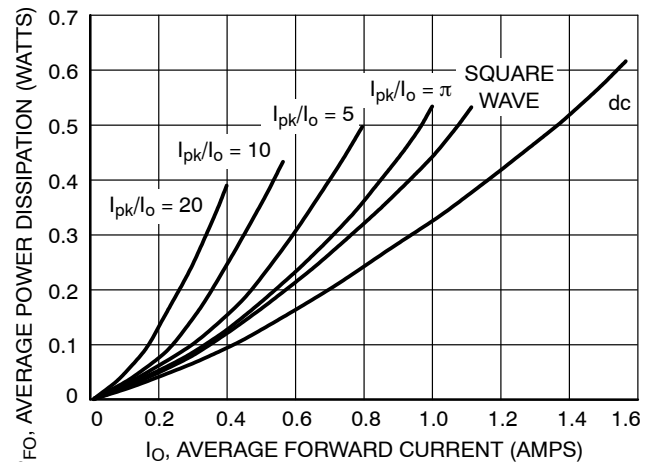

Figure 6. Forward Power Dissipation

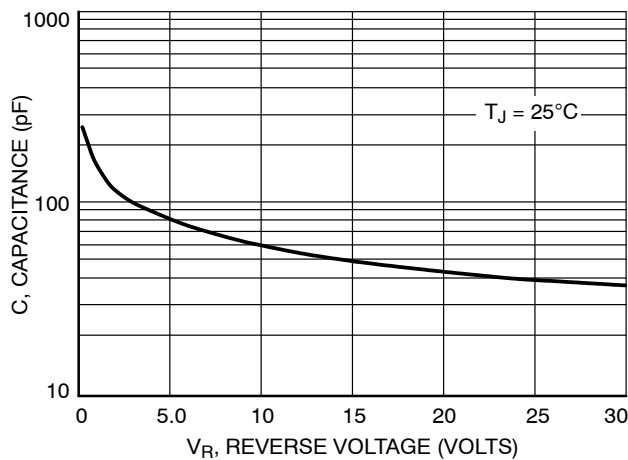

Figure 7. Capacitance

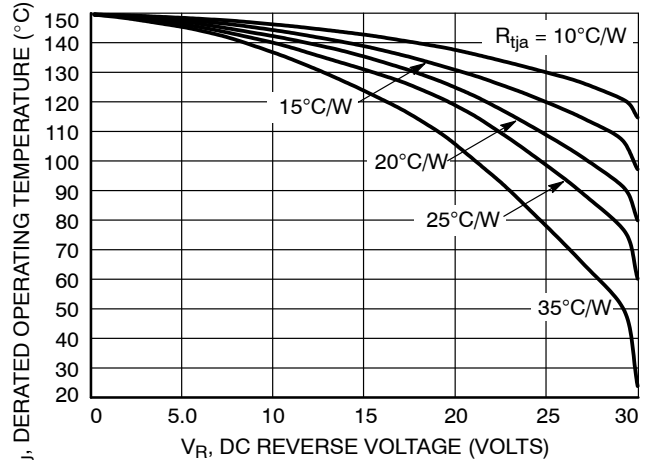

Figure 8. Typical Operating Temperature Derating*

* Reverse power dissipation and the possibility of thermal runaway must be considered when operating this device under any reverse voltage conditions. Calculations of T_J therefore must include forward and reverse power effects. The allowable operating T_J may be calculated from the equation:

$$T_J = T_{Jmax} - r(t)(P_f + P_r) \text{ where}$$

$r(t)$ = thermal impedance under given conditions,
 P_f = forward power dissipation, and
 P_r = reverse power dissipation

This graph displays the derated allowable T_J due to reverse bias under DC conditions only and is calculated as $T_J = T_{Jmax} - r(t)P_r$, where $r(t) = R_{thja}$. For other power applications further calculations must be performed.

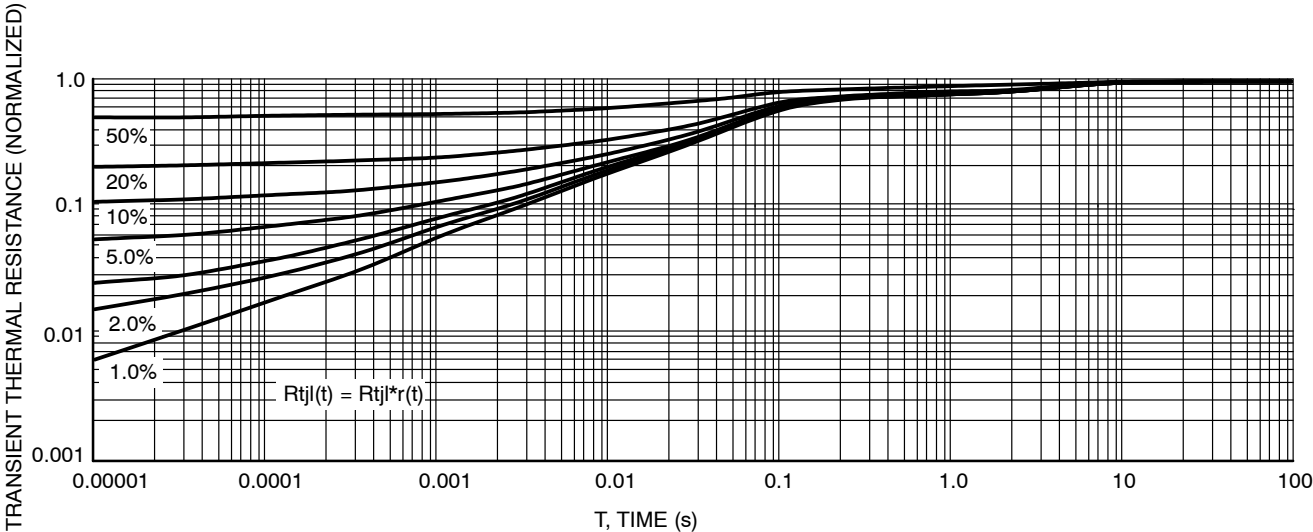

Figure 9. Thermal Response Junction to Lead

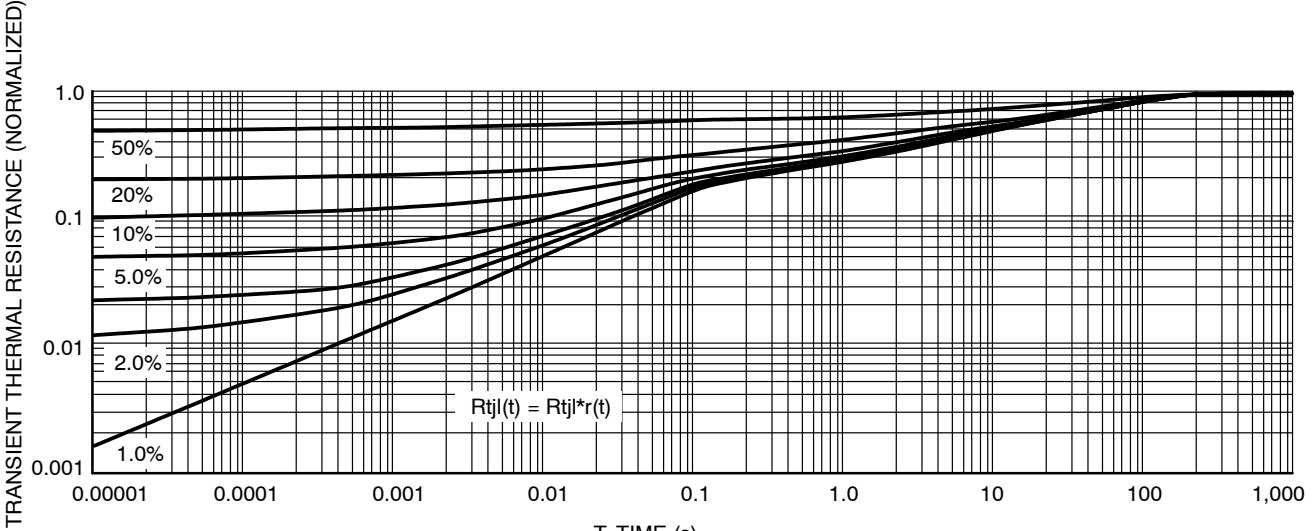
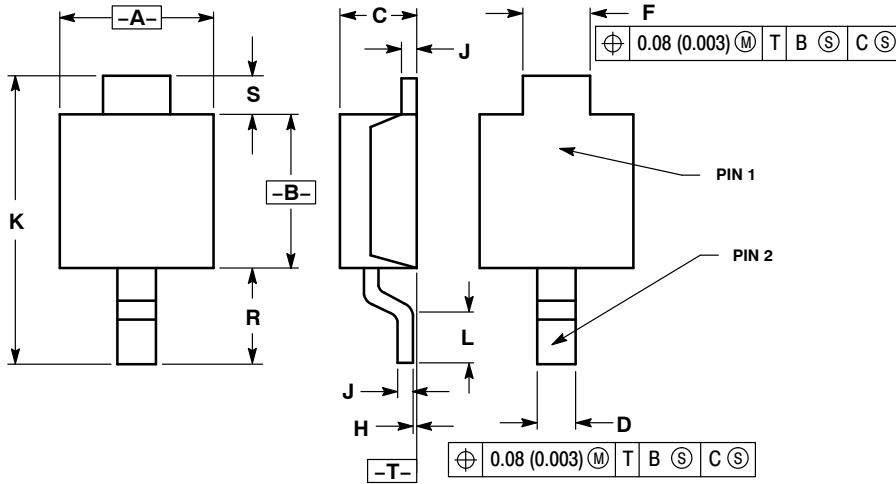

Figure 10. Thermal Response Junction to Ambient

MBRM130LT1G, NRVBM130LT1G, MBRM130LT3G, NRVBM130LT3G

PACKAGE DIMENSIONS

POWERMITE
CASE 457-04
ISSUE E



NOTES:

1. DIMENSIONING AND TOLERANCING PER ANSI Y14.5M, 1982.
2. CONTROLLING DIMENSION: MILLIMETER.
3. DIMENSION A DOES NOT INCLUDE MOLD FLASH, PROTRUSIONS OR GATE BURRS. MOLD FLASH, PROTRUSIONS OR GATE BURRS SHALL NOT EXCEED 0.15 (0.006) PER SIDE.

DIM	MILLIMETERS		INCHES	
	MIN	MAX	MIN	MAX
A	1.75	2.05	0.069	0.081
B	1.75	2.18	0.069	0.086
C	0.85	1.15	0.033	0.045
D	0.40	0.69	0.016	0.027
F	0.70	1.00	0.028	0.039
H	-0.05	+0.10	-0.002	+0.004
J	0.10	0.25	0.004	0.010
K	3.60	3.90	0.142	0.154
L	0.50	0.80	0.020	0.031
R	1.20	1.50	0.047	0.059
S	0.50 REF		0.019 REF	

STYLE 1:

1. CATHODE
2. ANODE

SOLDERING FOOTPRINT*

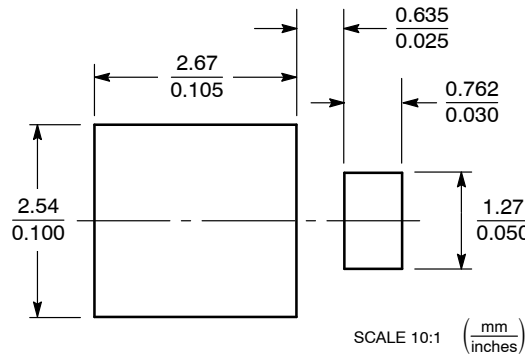

*For additional information on our Pb-Free strategy and soldering details, please download the ON Semiconductor Soldering and Mounting Techniques Reference Manual, SOLDERRM/D.

POWERMITE is a registered trademark of and used under a license from Microsemi Corporation.

ON Semiconductor and are registered trademarks of Semiconductor Components Industries, LLC (SCILLC). SCILLC reserves the right to make changes without further notice to any products herein. SCILLC makes no warranty, representation or guarantee regarding the suitability of its products for any particular purpose, nor does SCILLC assume any liability arising out of the application or use of any product or circuit, and specifically disclaims any and all liability, including without limitation special, consequential or incidental damages. "Typical" parameters which may be provided in SCILLC data sheets and/or specifications can and do vary in different applications and actual performance may vary over time. All operating parameters, including "Typicals" must be validated for each customer application by customer's technical experts. SCILLC does not convey any license under its patent rights nor the rights of others. SCILLC products are not designed, intended, or authorized for use as components in systems intended for surgical implant into the body, or other applications intended to support or sustain life, or for any other application in which the failure of the SCILLC product could create a situation where personal injury or death may occur. Should Buyer purchase or use SCILLC products for any such unintended or unauthorized application, Buyer shall indemnify and hold SCILLC and its officers, employees, subsidiaries, affiliates, and distributors harmless against all claims, costs, damages, and expenses, and reasonable attorney fees arising out of, directly or indirectly, any claim of personal injury or death associated with such unintended or unauthorized use, even if such claim alleges that SCILLC was negligent regarding the design or manufacture of the part. SCILLC is an Equal Opportunity/Affirmative Action Employer. This literature is subject to all applicable copyright laws and is not for resale in any manner.

PUBLICATION ORDERING INFORMATION

LITERATURE FULFILLMENT:
Literature Distribution Center for ON Semiconductor
P.O. Box 5163, Denver, Colorado 80217 USA
Phone: 303-675-2175 or 800-344-3860 Toll Free USA/Canada
Fax: 303-675-2176 or 800-344-3867 Toll Free USA/Canada
Email: orderlit@onsemi.com

N. American Technical Support: 800-282-9855 Toll Free USA/Canada
Europe, Middle East and Africa Technical Support:
Phone: 421 33 790 2910
Japan Customer Focus Center
Phone: 81-3-5817-1050

ON Semiconductor Website: www.onsemi.com
Order Literature: <http://www.onsemi.com/orderlit>
For additional information, please contact your local Sales Representative