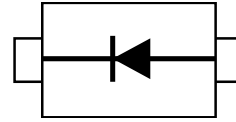

Feature

- Ultra Small mold type. (SOD523)
- Low I_R
- High reliability.

Applications

- Low current rectification

Construction

- Silicon epitaxial planar

Mechanical Characteristics

- Lead finish:100% matte Sn(Tin)
- Mounting position: Any
- Qualified max reflow temperature:260°C
- Device meets MSL 1 requirements
- Pure tin plating: 7 ~ 17 μm
- Pin flatness : $\leq 3\text{mil}$

Electrical characteristics per line@25°C

Parameter	Symbol	Min.	Typ.	Max.	Unit	Conditions
Forward voltage	V_F	-	-	0.47	V	$I_F=100\text{mA}$
Reverse current	I_R	-	-	30	μA	$V_R=10\text{V}$

Absolute maximum rating@25°C

Parameter	Symbol	limits	Unit
Reverse voltage (DC)	V_{RM}	20	V
Average rectified forward current	I_o	100	mA
Forward current surge peak (60Hz 1cyc)	I_{FSM}	0.4	A
Operating Junction temperature Range	T_j	-55 to 125	°C
Storage temperature	T_{stg}	-40 to +125	°C

Typical Characteristics

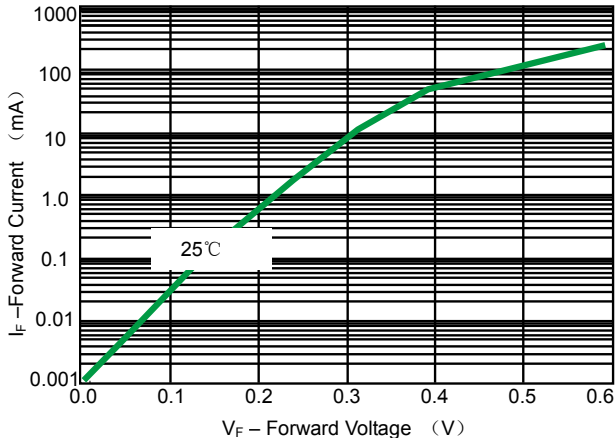

Fig 1. Forward Voltage

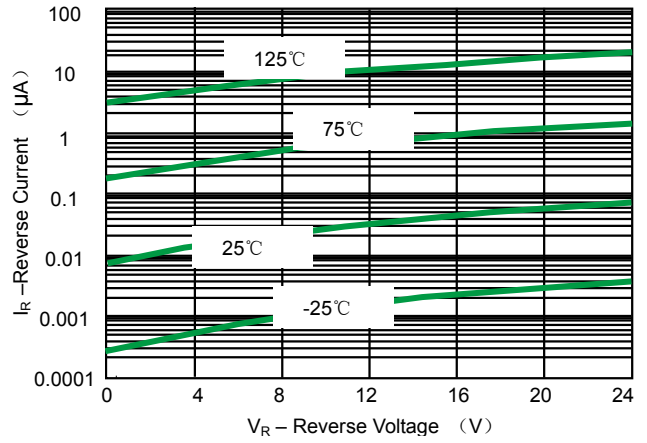

Fig 2. Leakage Current

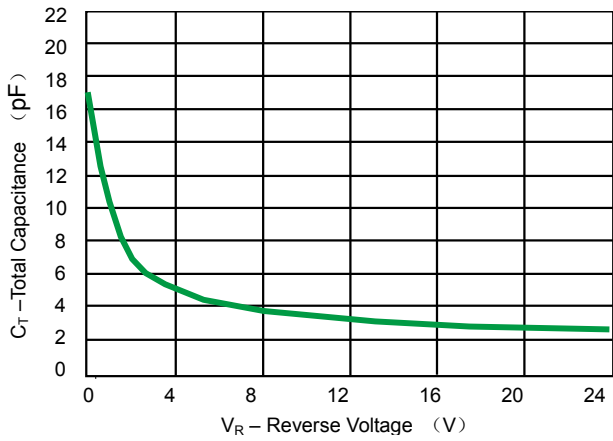
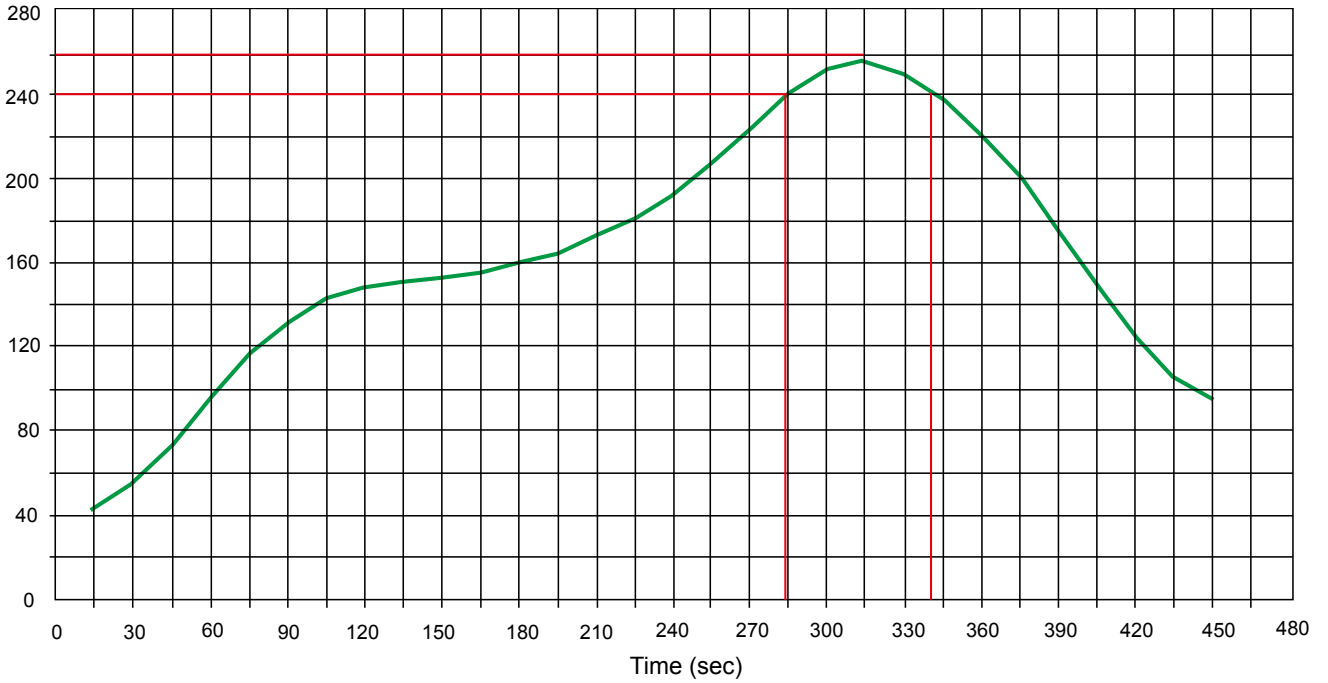

Fig 3. Total Capacitance

Solder Reflow Recommendation

Peak Temp=257°C, Ramp Rate=0.802deg. °C/sec



Product dimension (SOD-523)

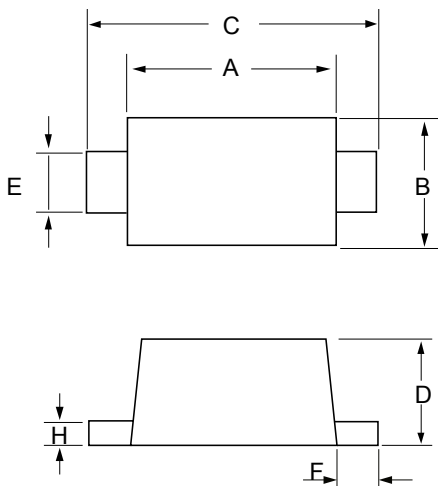

Dim	Inches		Millimeters	
	MIN	MAX	MIN	MAX
A	0.043	0.051	1.10	1.30
B	0.028	0.035	0.70	0.90
C	0.059	0.067	1.50	1.70
D	0.020	0.028	0.50	0.70
E	0.010	0.014	0.25	0.35
F	0.006	0.010	0.15	0.25
H	0.0028	0.0079	0.07	0.20

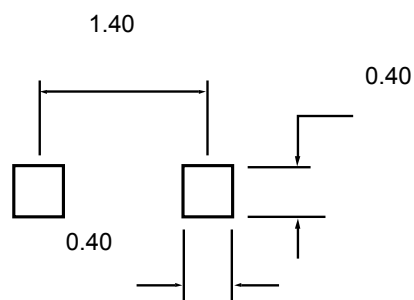

Unit:mm

Ordering information

Device	Package	Shipping
PSBD2001	SOD-523 (Pb-Free)	3000 / Tape & Reel

IMPORTANT NOTICE

 and **Prisemi**[®] are registered trademarks of **Prisemi Electronics Co., Ltd (Prisemi)** ,Prisemi reserves the right to make changes without further notice to any products herein. Prisemi makes no warranty, representation or guarantee regarding the suitability of its products for any particular purpose, nor does Prisemi assume any liability arising out of the application or use of any product or circuit, and specifically disclaims any and all liability, including without limitation special, consequential or incidental damages. “Typical” parameters which may be provided in Prisemi data sheets and/or specifications can and do vary in different applications and actual performance may vary over time. All operating parameters, including “Typicals” must be validated for each customer application by customer’s technical experts. Prisemi does not convey any license under its patent rights nor the rights of others. The products listed in this document are designed to be used with ordinary electronic equipment or devices, Should you intend to use these products with equipment or devices which require an extremely high level of reliability and the malfunction of with would directly endanger human life (such as medical instruments, aerospace machinery, nuclear-reactor controllers, fuel controllers and other safety devices), please be sure to consult with our sales representative in advance.

Website: <http://www.prisemi.com>

For additional information, please contact your local Sales Representative.

©Copyright 2009, Prisemi Electronics

 **Prisemi**[®] is a registered trademark of Prisemi Electronics.

All rights are reserved.