

ERA32-01/ERA32-02

High Efficiency Rectifier

VOLTAGE RANGE: 100 --- 200 V

CURRENT: 1.0 A



DO - 41

Features

- ◇ Low cost
- ◇ Diffused junction
- ◇ Low leakage
- ◇ Low forward voltage drop
- ◇ High current capability
- ◇ Easily cleaned with alcohol, Isopropanol and similar solvents
- ◇ The plastic material carries U/L recognition 94V-0

Mechanical Data

- ◇ Case: JEDEC DO-41, molded plastic
- ◇ Polarity: Color band denotes cathode
- ◇ Weight: 0.012 ounces, 0.34 grams
- ◇ Mounting position: Any

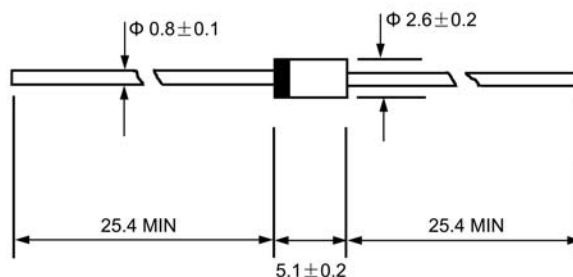

Dimensions in millimeters

MAXIMUM RATINGS AND ELECTRICAL CHARACTERISTICS

Ratings at 25°C ambient temperature unless otherwise specified.

Single phase, half wave, 60 Hz, resistive or inductive load. For capacitive load, derate by 20%.

		ERA32 - 01	ERA32 - 02	UNITS
Maximum recurrent peak reverse voltage	V_{RRM}	100	200	V
Maximum RMS voltage	V_{RMS}	70	140	V
Maximum DC blocking voltage	V_{DC}	100	200	V
Maximum average forward rectified current 9.5mm lead length, @ $T_A=75^\circ\text{C}$	$I_{F(AV)}$	1.0		A
Peak forward surge current 8.3ms single half-sine-wave superimposed on rated load @ $T_J=125^\circ\text{C}$	I_{FSM}	40.0		A
Maximum instantaneous forward voltage @ 1.0A	V_F	0.92		V
Maximum reverse current @ $T_A=25^\circ\text{C}$ at rated DC blocking voltage @ $T_A=100^\circ\text{C}$	I_R	5.0 50.0		μA
Maximum reverse recovery time (Note1)	t_{rr}	50		ns
Typical junction capacitance (Note2)	C_J	20		pF
Typical thermal resistance (Note3)	$R_{\theta JA}$	60		$^\circ\text{C/W}$
Operating junction temperature range	T_J	- 55 ----- + 150		$^\circ\text{C}$
Storage temperature range	T_{STG}	- 55 ----- + 150		$^\circ\text{C}$

NOTE: 1. Measured with $I_F=0.5\text{A}$, $I_R=1\text{A}$, $I_{rr}=0.25\text{A}$.

2. Measured at 1.0MHz and applied reverse voltage of 4.0V DC.

3. Thermal resistance from junction to ambient.

Ratings AND Characteristic Curves

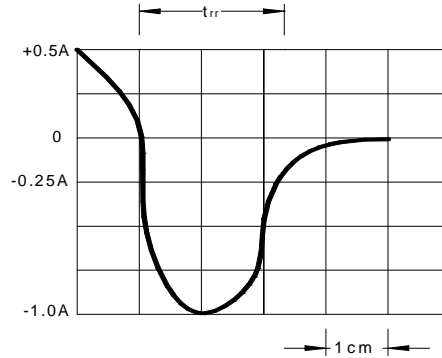
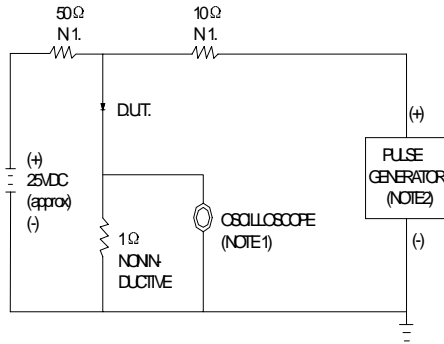
FIG.1-TEST CIRCUIT DIAGRAM AND REVERSE RECOVERY TIME CHARACTERISTIC

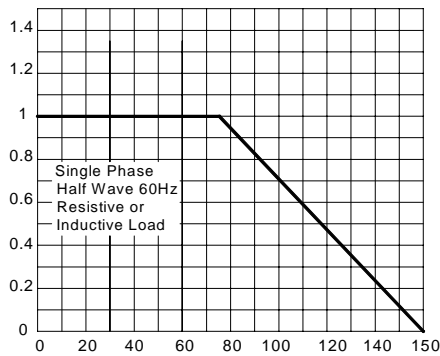
FIG.3 -FORWARD DERATING CURVE

 AVERAGE FORWARD RECTIFIED CURRENT.
AMPERES

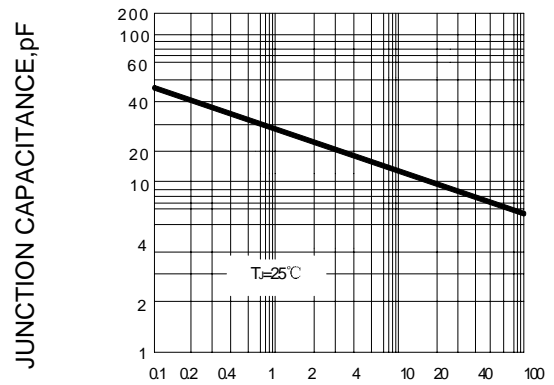
AMBIENT TEMPERATURE. °C

FIG.4-TYPICAL JUNCTION CAPACITANCE

REVERSE VOLTAGE, VOLTS

FIG.5-PEAK FORWARD SURGE CURRENT

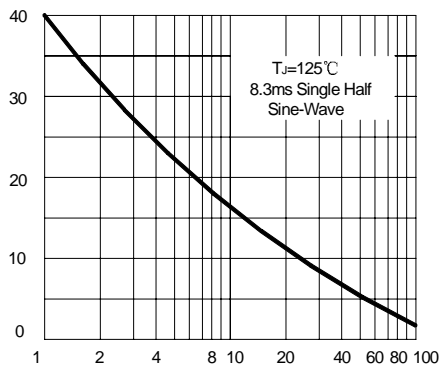
 PEAK FORWARD SURGE CURRENT.
AMPERES

NUMBER OF CYCLES AT 60Hz

FIG.1 - TYPICAL FORWARD CHARACTERISTIC

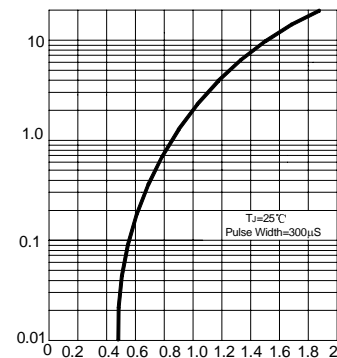
 INSTANTANEOUS FORWARD CURRENT
AMPERES

INSTANTANEOUS FORWARD VOLTAGE, VOLTS