

HER2010FC-HER2060FC

High Efficiency Rectifiers

VOLTAGE RANGE: 100 --- 600 V

CURRENT: 20 A

ITO - 220AB



Features

- ◇ Low cost
- ◇ Low leakage
- ◇ Low forward voltage drop
- ◇ High current capability
- ◇ Easily cleaned with alcohol, Isopropanol and similar solvents
- ◇ The plastic material carries U/L recognition 94V-0

Mechanical Data

- ◇ Case: JEDEC ITO-220AB, molded plastic
- ◇ Polarity: As marked
- ◇ Weight: 0.06 ounces, 1.67 grams
- ◇ Mounting position: Any

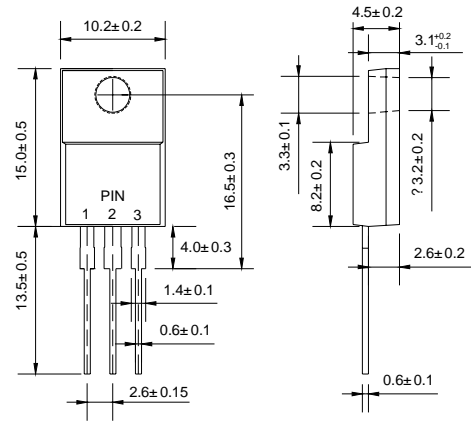

Dimensions in millimeters

MAXIMUM RATINGS AND ELECTRICAL CHARACTERISTICS

Ratings at 25°C ambient temperature unless otherwise specified.

Single phase, half wave, 60 Hz, resistive or inductive load. For capacitive load, derate by 20%.

		HER 2010FC	HER 2020FC	HER 2040FC	HER 2060FC	UNITS
Maximum recurrent peak reverse voltage	V_{RRM}	100	200	400	600	V
Maximum RMS voltage	V_{RMS}	70	140	280	420	V
Maximum DC blocking voltage	V_{DC}	100	200	400	600	V
Maximum average forward rectified current @ $T_C=75^\circ\text{C}$	$I_{F(AV)}$	20				A
Peak forward surge current 8.3ms single half-sine-wave superimposed on rated load @ $T_J=125^\circ\text{C}$	I_{FSM}	200				A
Maximum instantaneous forward voltage @ 10A	V_F	1.0		1.3	1.7	V
Maximum reverse current @ $T_C=25^\circ\text{C}$ at rated DC blocking voltage @ $T_C=100^\circ\text{C}$	I_R		10 150			μA
Maximum reverse recovery time (Note1)	t_{rr}		50		100	ns
Typical junction capacitance (Note2)	C_J		40			pF
Typical thermal resistance (Note3)	$R_{\theta JC}$		2.5			$^\circ\text{C/W}$
Operating junction temperature range	T_J	- 55 ---- + 150				$^\circ\text{C}$
Storage temperature range	T_{STG}	- 55 ---- + 150				$^\circ\text{C}$

NOTE: 1. Measured with $I_F=0.5\text{A}$, $I_R=1\text{A}$, $I_{rr}=0.25\text{A}$.

2. Measured at 1.0MHz and applied reverse voltage of 4.0V DC.

3. Thermal resistance junction to case.

Ratings AND Characteristic Curves

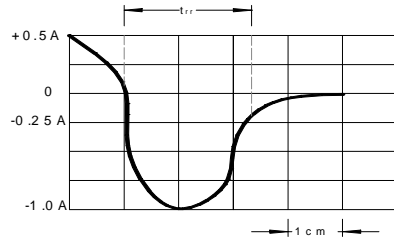
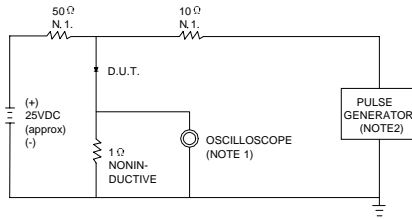
FIG.1 -- TEST CIRCUIT DIAGRAM AND REVERSE RECOVERY TIME CHARACTERISTIC

NOTES:1.RISE TIME = 7ns MAX.INPUT IMPEDANCE = 1MΩ .22pF.
2.RISE TIME =10ns MAX.SOURCE IMPEDANCE=50 Ω .

SET TIME BASE FOR 25 ns/cm

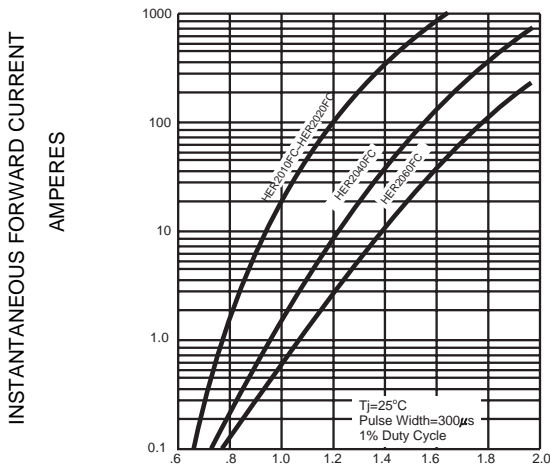
FIG.2 -- TYPICAL FORWARD CHARACTERISTIC

INSTANTANEOUS FORWARD VOLTAGE, VOLTS

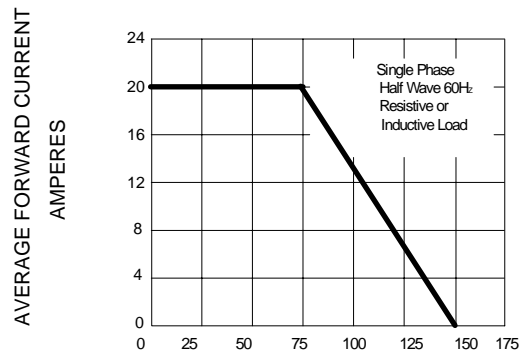
FIG.3 -- FORWARD DERATING CURVE

CASE TEMPERATURE, °C

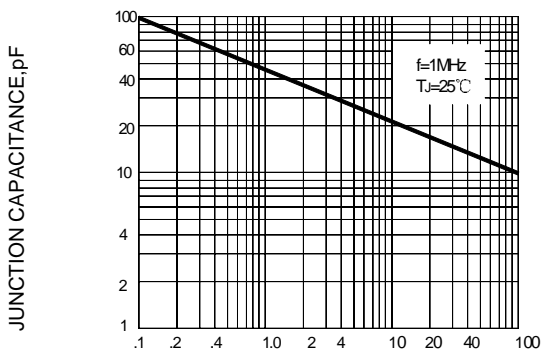
FIG.4 -- TYPICAL JUNCTION CAPACITANCE

REVERSE VOLTAGE, VOLTS

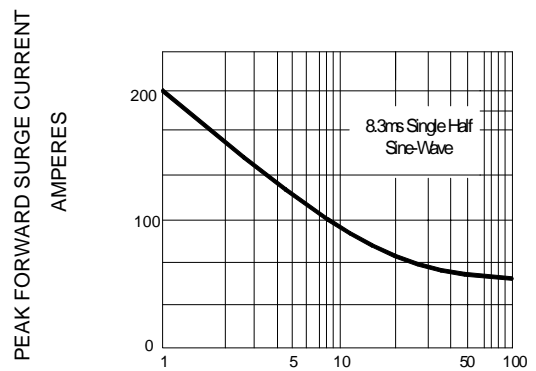
FIG.5 -- PEAK FORWARD SURGE CURRENT

NUMBER OF CYCLES AT 60Hz