

# Sonic Fast Recovery Diode

High Performance Fast Recovery Diode  
 Low Loss and Soft Recovery  
 Single Diode

$V_{RRM} = 1600\text{ V}$   
 $I_{FAV} = 60\text{ A}$   
 $t_{rr} = 230\text{ ns}$

Part number

**DH60-16A**

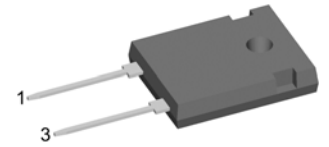
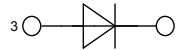

Backside: cathode

**Features / Advantages:**

- Planar passivated chips
- Very low leakage current
- Very short recovery time
- Improved thermal behaviour
- Very low  $I_{rm}$ -values
- Very soft recovery behaviour
- Avalanche voltage rated for reliable operation
- Soft reverse recovery for low EMI/RFI
- Low  $I_{rm}$  reduces:
  - Power dissipation within the diode
  - Turn-on loss in the commutating switch

**Applications:**

- Antiparallel diode for high frequency switching devices
- Antisaturation diode
- Snubber diode
- Free wheeling diode
- Rectifiers in switch mode power supplies (SMPS)
- Uninterruptible power supplies (UPS)

**Package:**

- Housing: TO-247
- Industry standard outline
- Epoxy meets UL 94V-0
- RoHS compliant

**Ratings**

Symbol	Definition	Conditions	Ratings			Unit
			min.	typ.	max.	
$V_{RRM}$	max. repetitive reverse voltage				1600	V
$I_R$	reverse current	$V_R = 1600\text{ V}$			200	$\mu\text{A}$
		$V_R = 1600\text{ V}$			2	mA
$V_F$	forward voltage	$I_F = 60\text{ A}$			2.04	V
		$I_F = 120\text{ A}$			2.57	V
		$I_F = 60\text{ A}$			2.05	V
		$I_F = 120\text{ A}$			2.78	V
$I_{FAV}$	average forward current	rectangular d = 0.5			60	A
$V_{F0}$	threshold voltage	} for power loss calculation only			1.28	V
$r_F$	slope resistance				12	m $\Omega$
$R_{thJC}$	thermal resistance junction to case				0.30	K/W
$T_{VJ}$	virtual junction temperature		-55		150	$^{\circ}\text{C}$
$P_{tot}$	total power dissipation				415	W
$I_{FSM}$	max. forward surge current	t = 10 ms (50 Hz), sine			700	A
$I_{RM}$	max. reverse recovery current				60	A
		$I_F = 60\text{ A}; V_R = 1200\text{ V}$			70	A
$t_{rr}$	reverse recovery time	$-di_F/dt = 800\text{ A}/\mu\text{s}$			230	ns
					350	ns
$C_J$	junction capacitance	$V_R = 1200\text{ V}; f = 1\text{ MHz}$			32	pF

Symbol	Definition	Conditions	Ratings			Unit
			min.	typ.	max.	
$I_{RMS}$	RMS current	per terminal			70	A
$R_{thCH}$	thermal resistance case to heatsink			0.25		K/W
$T_{stg}$	storage temperature		-55		150	°C
<b>Weight</b>				6		g
$M_D$	mounting torque		0.8		1.2	Nm
$F_C$	mounting force with clip		20		120	N

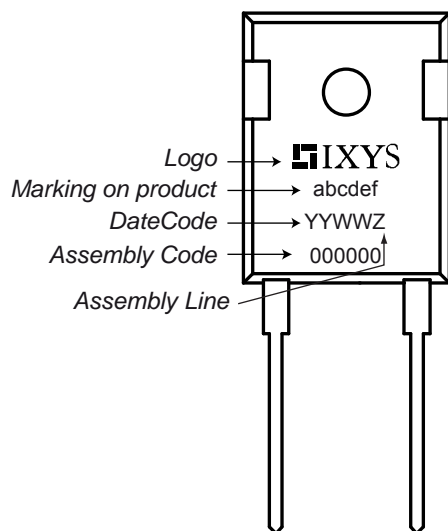
**Product Marking**

Ordering	Part Name	Marking on Product	Delivering Mode	Base Qty	Code Key
Standard	DH60-16A	DH60-16A	Tube	30	496545

Similar Part	Package	Voltage Class
DH60-14A	TO-247AD (2)	1400
DH60-18A	TO-247AD (2)	1800

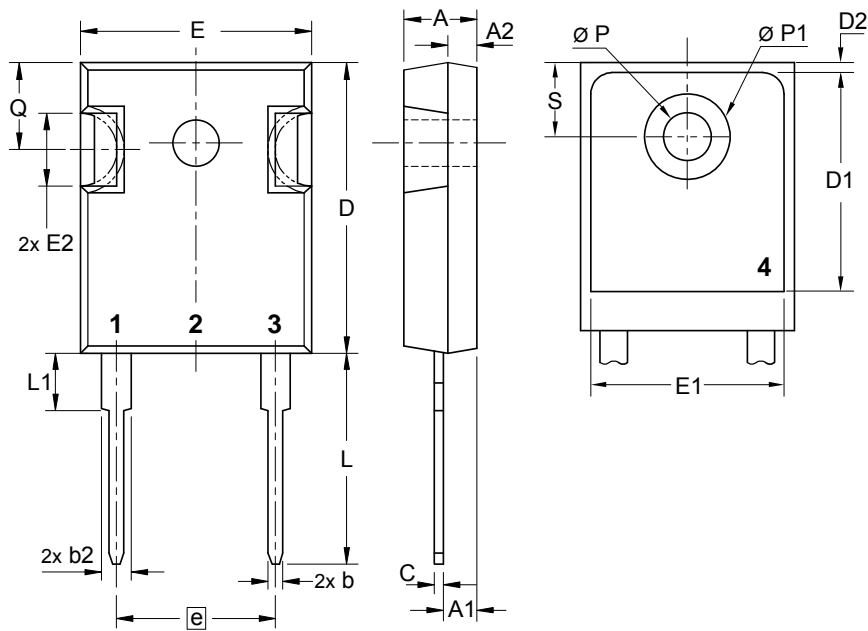
**Outlines TO-247**

Sym.	Inches		Millimeter	
	min.	max.	min.	max.
A	0.185	0.209	4.70	5.30
A1	0.087	0.102	2.21	2.59
A2	0.059	0.098	1.50	2.49
D	0.819	0.845	20.79	21.45
E	0.610	0.640	15.48	16.24
E2	0.170	0.216	4.31	5.48
e	0.430 BSC		10.92 BSC	
L	0.780	0.800	19.80	20.30
L1	-	0.177	-	4.49
Ø P	0.140	0.144	3.55	3.65
Q	0.212	0.244	5.38	6.19
S	0.242 BSC		6.14 BSC	
b	0.039	0.055	0.99	1.40
b2	0.065	0.094	1.65	2.39
b4	0.102	0.135	2.59	3.43
c	0.015	0.035	0.38	0.89
D1	0.515	-	13.07	-
D2	0.020	0.053	0.51	1.35
E1	0.530	-	13.45	-
Ø P1	-	0.29	-	7.39

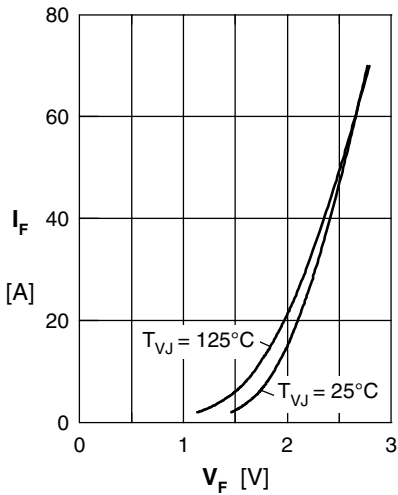

Fig. 1 Typ. ward current  $I_F$  versus  $V_F$

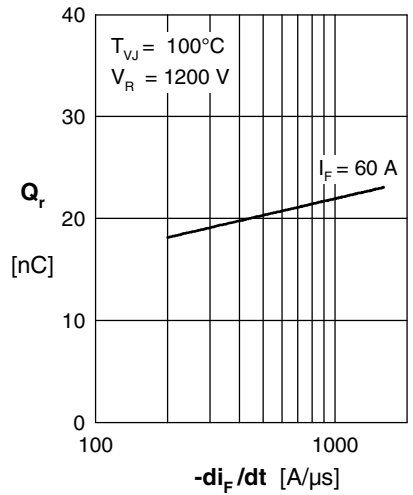

Fig. 2 Typ. reverse recovery charge  $Q_r$  versus  $-di_F/dt$

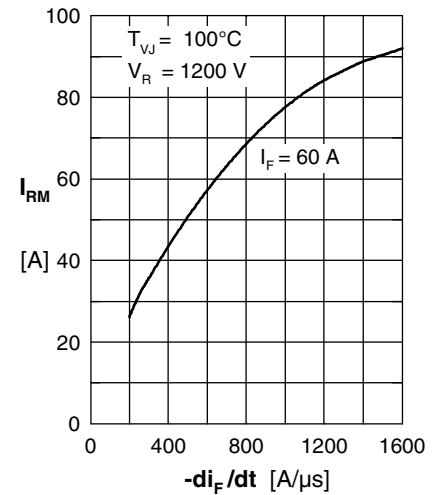

Fig. 3 Typ. peak reverse current  $I_{RM}$  versus  $-di_F/dt$

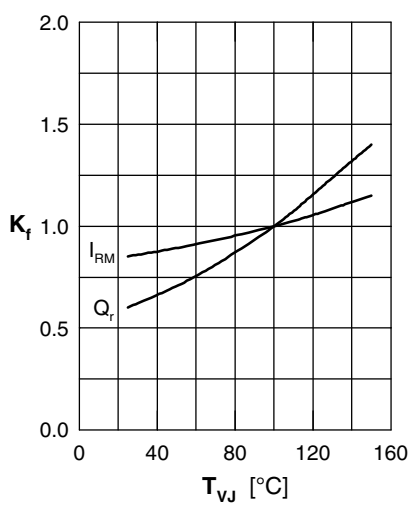

Fig. 4 Dynamic parameters  $Q_r$ ,  $I_{RM}$  versus  $T_{VJ}$

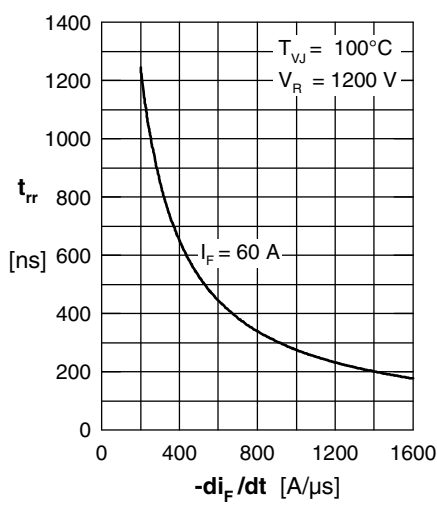

Fig. 5 Typ. recovery time  $t_{rr}$  versus  $-di_F/dt$

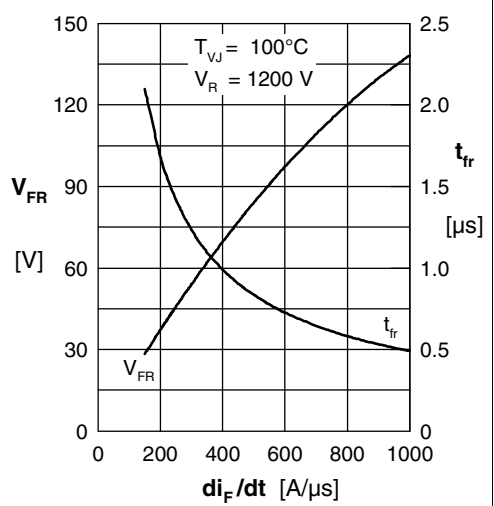

Fig. 6 Typ. peak forward voltage  $V_{FR}$  & typ. forward recovery time  $t_{fr}$  versus  $di_F/dt$

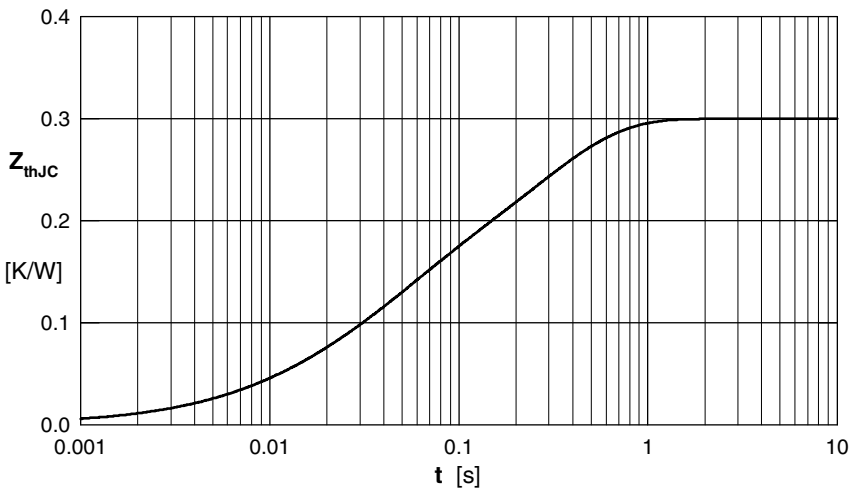

Fig. 7 Transient thermal resistance junction to case

i	$R_i$	$\square$
1	0.021	0.0093
2	0.11	0.038
3	0.169	0.274