

MG1775S-BN4MM



Agency Approvals

AGENCY	AGENCY FILE NUMBER
	E71639

Features

- IGBT³ CHIP(1700V Trench+Field Stop technology)
- Low turn-off losses, short tail current
- $V_{CE(sat)}$ with positive temperature coefficient
- DIODE CHIP(1700V EMCON 3 technology)
- Free wheeling diodes with fast and soft reverse recovery

Applications

- High frequency switching application
- Medical applications
- Motion/servo control
- UPS systems

Module Characteristics ($T_c = 25^\circ\text{C}$, unless otherwise specified)

Symbol	Parameters	Test Conditions	Min	Typ	Max	Unit
$T_{J(max)}$	Max. Junction Temperature				150	$^\circ\text{C}$
$T_{J(op)}$	Operating Temperature		-40		125	$^\circ\text{C}$
T_{stg}	Storage Temperature		-40		125	$^\circ\text{C}$
V_{isol}	Insulation Test Voltage	AC, t=1min		4000		V
CTI	Comparative Tracking Index		350			
Torque	Module-to-Sink	Recommended (M6)	3		5	N·m
Torque	Module Electrodes	Recommended (M5)	2.5		5	N·m
Weight				160		g

Absolute Maximum Ratings ($T_c = 25^\circ\text{C}$, unless otherwise specified)

Symbol	Parameters	Test Conditions	Values	Unit
IGBT				
V_{CES}	Collector - Emitter Voltage	$T_J=25^\circ\text{C}$	1700	V
V_{GES}	Gate - Emitter Voltage		± 20	V
I_C	DC Collector Current	$T_c=25^\circ\text{C}$	125	A
		$T_c=80^\circ\text{C}$	75	A
I_{CM}	Repetitive Peak Collector Current	$t_p=1\text{ms}$	150	A
P_{tot}	Power Dissipation Per IGBT		520	W
Diode				
V_{RRM}	Repetitive Reverse Voltage	$T_J=25^\circ\text{C}$	1700	V
$I_{F(AV)}$	Average Forward Current	$T_c=25^\circ\text{C}$	125	A
		$T_c=80^\circ\text{C}$	75	A
I_{FRM}	Repetitive Peak Forward Current	$t_p=1\text{ms}$	150	A
I^2t		$T_J=125^\circ\text{C}$, $t=10\text{ms}$, $V_R=0\text{V}$	1050	A^2S

Life Support Note:

Not Intended for Use in Life Support or Life Saving Applications

The products shown herein are not designed for use in life sustaining or life saving applications unless otherwise expressly indicated.

MG1775S-BN4MM

Electrical and Thermal Specifications ($T_c = 25^\circ\text{C}$, unless otherwise specified)

Symbol	Parameters	Test Conditions	Min	Typ	Max	Unit
IGBT						
$V_{GE(th)}$	Gate - Emitter Threshold Voltage	$V_{CE}=V_{GE}, I_C=3.0\text{mA}$	5.2	5.8	6.4	V
$V_{CE(sat)}$	Collector - Emitter Saturation Voltage	$I_C=75\text{A}, V_{GE}=15\text{V}, T_J=25^\circ\text{C}$		2.0	2.45	V
		$I_C=75\text{A}, V_{GE}=15\text{V}, T_J=125^\circ\text{C}$		2.4		V
I_{CES}	Collector Leakage Current	$V_{CE}=1700\text{V}, V_{GE}=0\text{V}, T_J=25^\circ\text{C}$			3	mA
		$V_{CE}=1700\text{V}, V_{GE}=0\text{V}, T_J=125^\circ\text{C}$			20	mA
I_{GES}	Gate Leakage Current	$V_{CE}=0\text{V}, V_{GE}=\pm 20\text{V}, T_J=125^\circ\text{C}$	-400		400	nA
R_{Gint}	Integrated Gate Resistor			8.5		Ω
Q_{ge}	Gate Charge	$V_{CE}=900\text{V}, I_C=75\text{A}, V_{GE}=\pm 15\text{V}$		0.9		μC
C_{ies}	Input Capacitance	$V_{CE}=25\text{V}, V_{GE}=0\text{V}, f=1\text{MHz}$		6.8		nF
C_{res}	Reverse Transfer Capacitance			0.22		nF
$t_{d(on)}$	Turn - on Delay Time	$V_{CC}=900\text{V}$ $I_C=75\text{A}$ $R_G=6.8\Omega$ $V_{GE}=\pm 15\text{V}$ Inductive Load	$T_J=25^\circ\text{C}$		370	ns
			$T_J=125^\circ\text{C}$		400	ns
t_r	Rise Time		$T_J=25^\circ\text{C}$		40	ns
			$T_J=125^\circ\text{C}$		50	ns
$t_{d(off)}$	Turn - off Delay Time		$T_J=25^\circ\text{C}$		650	ns
			$T_J=125^\circ\text{C}$		800	ns
t_f	Fall Time		$T_J=25^\circ\text{C}$		180	ns
			$T_J=125^\circ\text{C}$		300	ns
E_{on}	Turn - on Energy		$T_J=25^\circ\text{C}$		16.5	mJ
			$T_J=125^\circ\text{C}$		24	mJ
E_{off}	Turn - off Energy	$T_J=25^\circ\text{C}$		16	mJ	
		$T_J=125^\circ\text{C}$		23.5	mJ	
I_{SC}	Short Circuit Current	$t_{psc}\leq 10\mu\text{S}, V_{GE}=15\text{V}, T_J=125^\circ\text{C}, V_{CC}=1000\text{V}$		300		A
R_{thJC}	Junction-to-Case Thermal Resistance (Per IGBT)				0.24	K/W
Diode						
V_F	Forward Voltage	$I_F=75\text{A}, V_{GE}=0\text{V}, T_J=25^\circ\text{C}$		1.8	2.2	V
		$I_F=75\text{A}, V_{GE}=0\text{V}, T_J=125^\circ\text{C}$		1.9		V
I_{RRM}	Max. Reverse Recovery Current	$I_F=75\text{A}, V_R=900\text{V}$		125		A
Q_{rr}	Reverse Recovery Charge	$di_r/dt=-1800\text{A}/\mu\text{s}$		36.5		μC
E_{rec}	Reverse Recovery Energy	$T_J=125^\circ\text{C}$		20.5		mJ
R_{thJCD}	Junction-to-Case Thermal Resistance (Per Diode)				0.45	K/W

Figure 1: Typical Output Characteristics

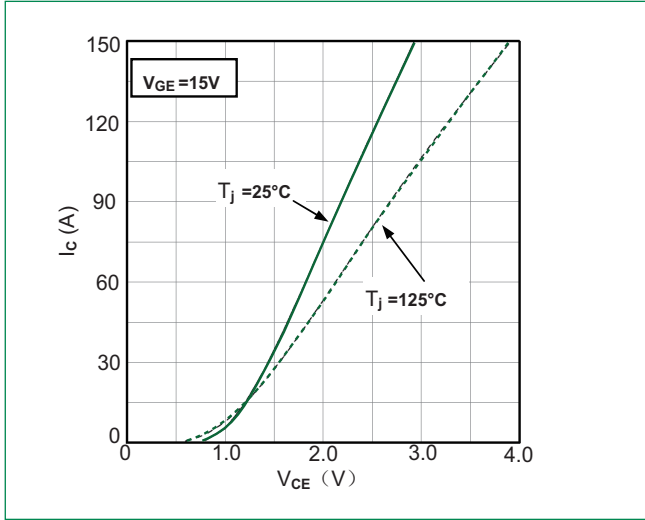

Figure 2: Typical Output Characteristics

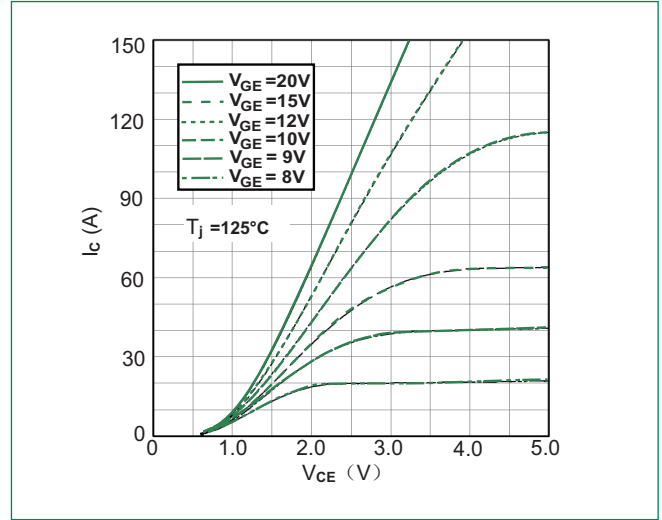

Figure 3: Typical Transfer characteristics

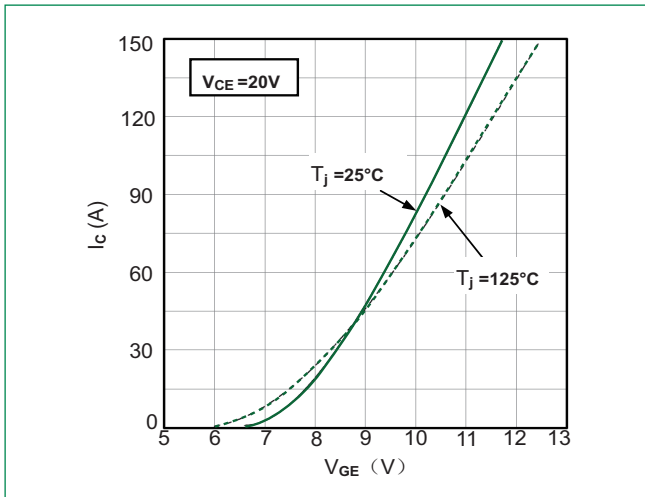

Figure 4: Switching Energy vs. Gate Resistor

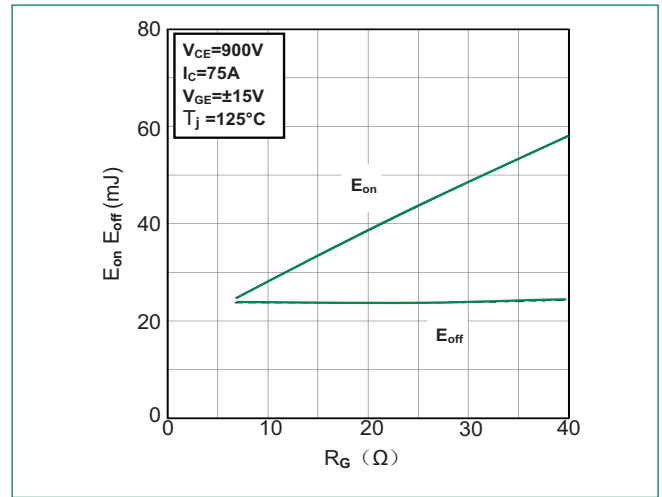

Figure 5: Switching Energy vs. Collector Current

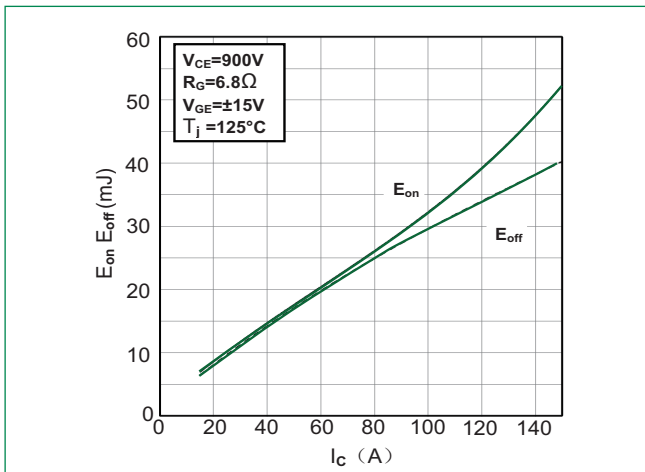

Figure 6: Reverse Biased Safe Operating Area

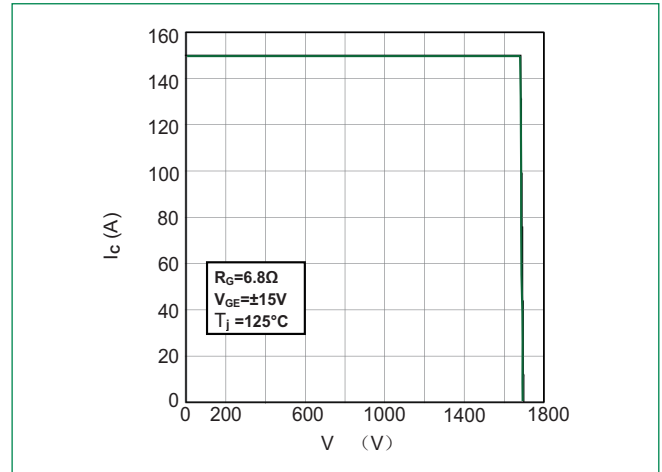

Figure 7: Diode Forward Characteristics

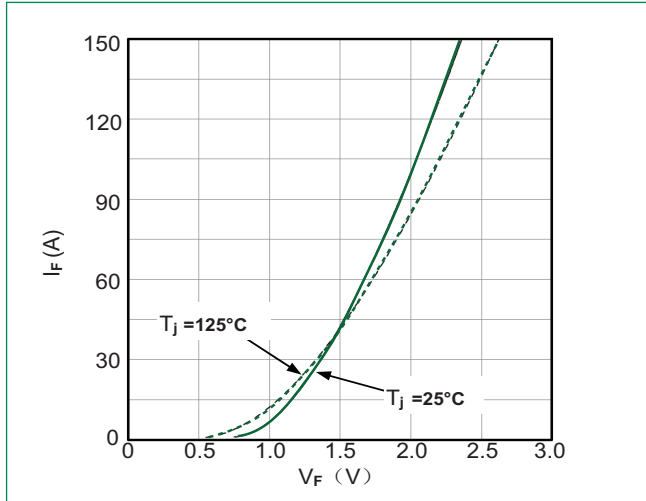

Figure 8: Switching Energy vs. Gate Resistor

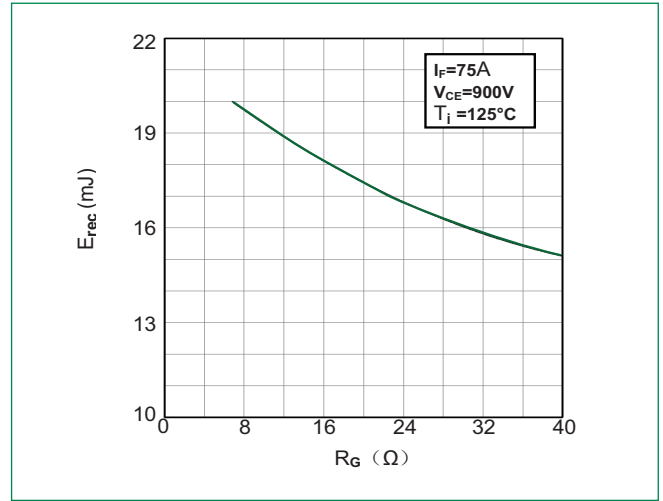

Figure 9: Switching Energy vs. Forward Current

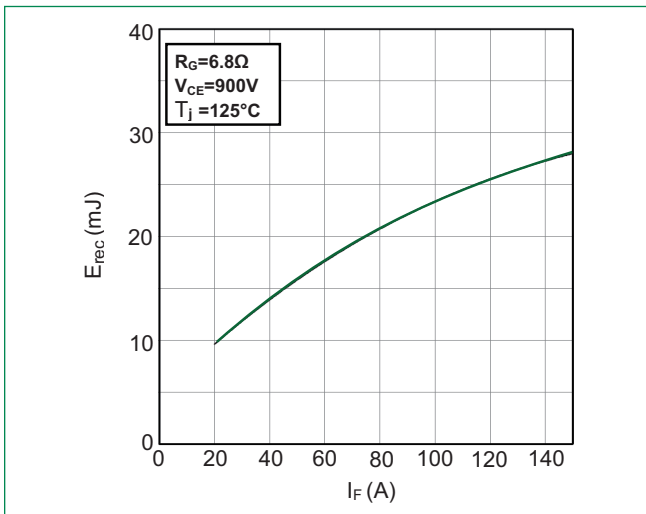
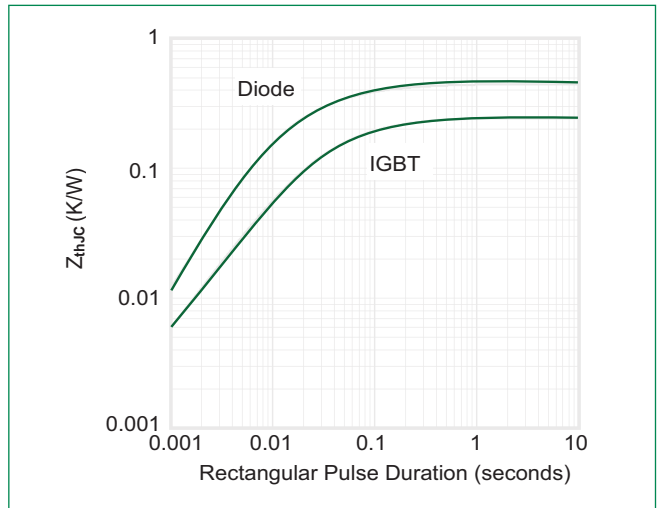
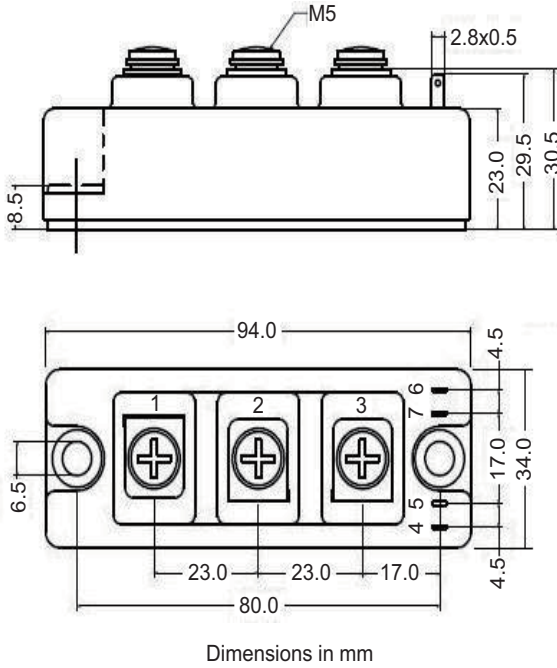

Figure 10: Transient Thermal Impedance of Diode and IGBT



Dimensions-Package S



Circuit Diagram

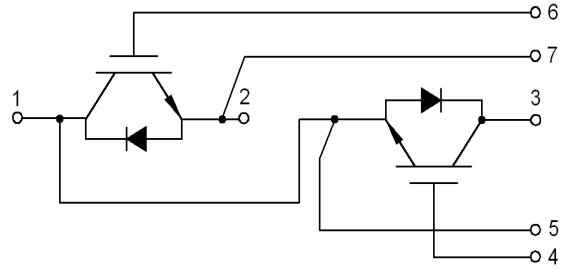

Packing Options

Part Number	Marking	Weight	Packing Mode	M.O.Q
MG1775S-BN4MM	MG1775S-BN4MM	160g	Bulk Pack	50

Part Numbering System

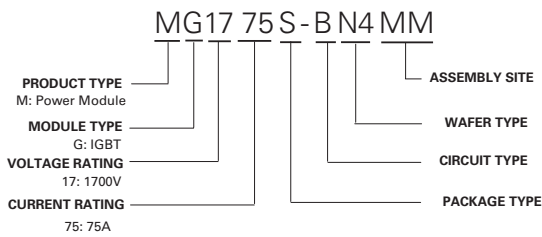

Part Marking System

