

Avionics Pulsed Power Transistor
850W, 1025-1150 MHz, 10µs Pulse, 1% Duty

M/A-COM Products
Released, 30 May 07

Features

- NPN silicon microwave power transistors
- Common base configuration
- Broadband Class C operation
- High efficiency inter-digitized geometry
- Diffused emitter ballasting resistors
- Gold metallization system
- Internal input and output impedance matching
- Hermetic metal/ceramic package
- RoHS compliant

Outline Drawing

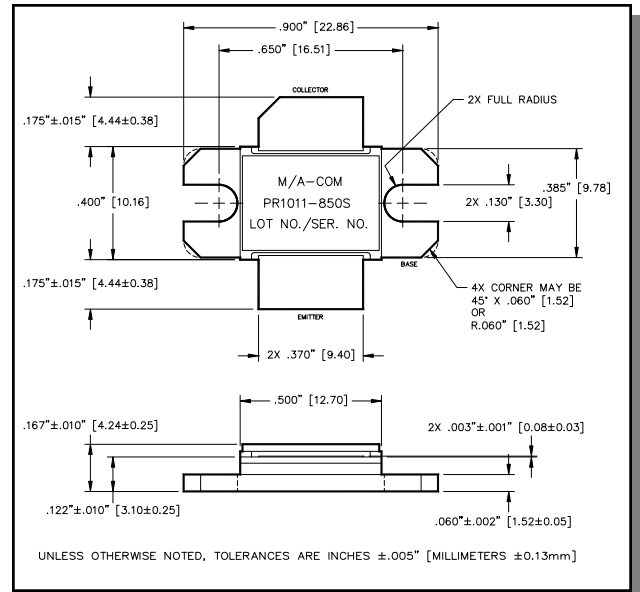

Absolute Maximum Ratings at 25°C

Parameter	Symbol	Rating	Units
Collector-Emitter Voltage	V_{CES}	80	V
Emitter-Base Voltage	V_{EBO}	3.0	V
Collector Current (Peak)	I_C	250	A
Power Dissipation @ +25°C	P_{TOT}	11.6	kW
Storage Temperature	T_{STG}	-65 to +200	°C
Junction Temperature	T_J	200	°C

Electrical Specifications: $T_C = 25 \pm 5^\circ\text{C}$ (Room Ambient)

Parameter	Test Conditions	Frequency	Symbol	Min	Max	Units
Collector-Emitter Breakdown Voltage	$I_C = 250\text{mA}$		BV_{CES}	80	-	V
Collector-Emitter Leakage Current	$V_{CE} = 50\text{V}$		I_{CES}	-	30	mA
Thermal Resistance	$V_{CC}=50\text{V}$, $P_{out}=850\text{W}$	$F = 1025, 1090, 1150\text{ MHz}$	$R_{TH(JC)}$	-	0.015	°C/W
Input Power	$V_{CC}=50\text{V}$, $P_{out}=850\text{W}$	$F = 1025, 1090, 1150\text{ MHz}$	P_{IN}	-	141	W
Power Gain	$V_{CC}=50\text{V}$, $P_{out}=850\text{W}$	$F = 1025, 1090, 1150\text{ MHz}$	G_P	7.8	-	dB
Collector Efficiency	$V_{CC}=50\text{V}$, $P_{out}=850\text{W}$	$F = 1025, 1090, 1150\text{ MHz}$	η_C	42	-	%
Input Return Loss	$V_{CC}=50\text{V}$, $P_{out}=850\text{W}$	$F = 1025, 1090, 1150\text{ MHz}$	RL	-	-9	dB
Load Mismatch Tolerance	$V_{CC}=50\text{V}$, $P_{out}=850\text{W}$	$F = 1025\text{ MHz}$	VSWR-T	-	5:1	-
Load Mismatch Stability *	$V_{CC}=50\text{V}$, $P_{out}=850\text{W}$	$F = 1025, 1090, 1150\text{ MHz}$	VSWR-S	-	1.5:1	-

* All spurious signals shall be < -60dBc below carrier, except $F = F_0 \pm \frac{1}{2} F_0$ shall be < -40dBc

Avionics Pulsed Power Transistor
850W, 1025-1150 MHz, 10 μ s Pulse, 1% Duty

M/A-COM Products
Released, 30 May 07

Typical RF Performance

Freq. (MHz)	Pin (W)	Pout (W)	Gain (dB)	Δ Gain (dB)	Ic (A)	Eff (%)	RL (dB)	VSWR-S (1.5:1)	VSWR-T (5:1)	P1dB Overdrive	
										Pout	Δ Po
1025	116	850	8.67	-	35.3	48.2	-18.3	S	P	974	0.59
1090	117	850	8.61	-	33.9	50.3	-16.3	S	-	1014	0.76
1150	112	850	8.42	0.25	32.1	53.0	-21.1	S	-	997	0.69

Note: Δ Po(dB) is the difference between Pout at 1dB overdrive and Pout at Pout=850W.

Gain vs. Frequency

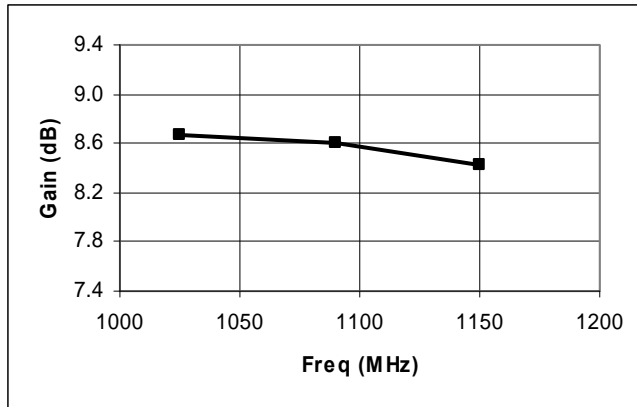

Collector Efficiency vs. Frequency

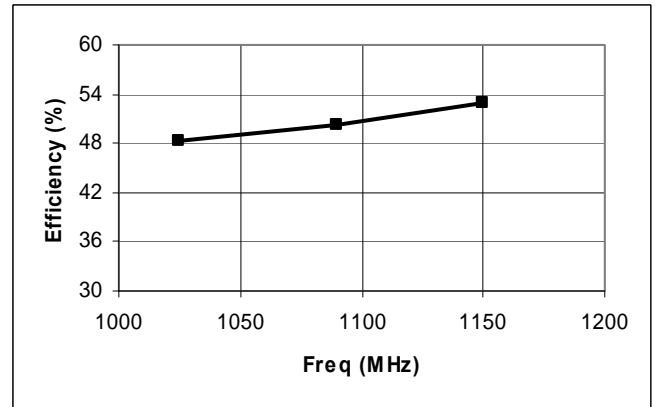

Avionics Pulsed Power Transistor
850W, 1025-1150 MHz, 10µs Pulse, 1% Duty

M/A-COM Products
Released, 30 May 07

RF Power Transfer Curve (Output Power Vs. Input Power)

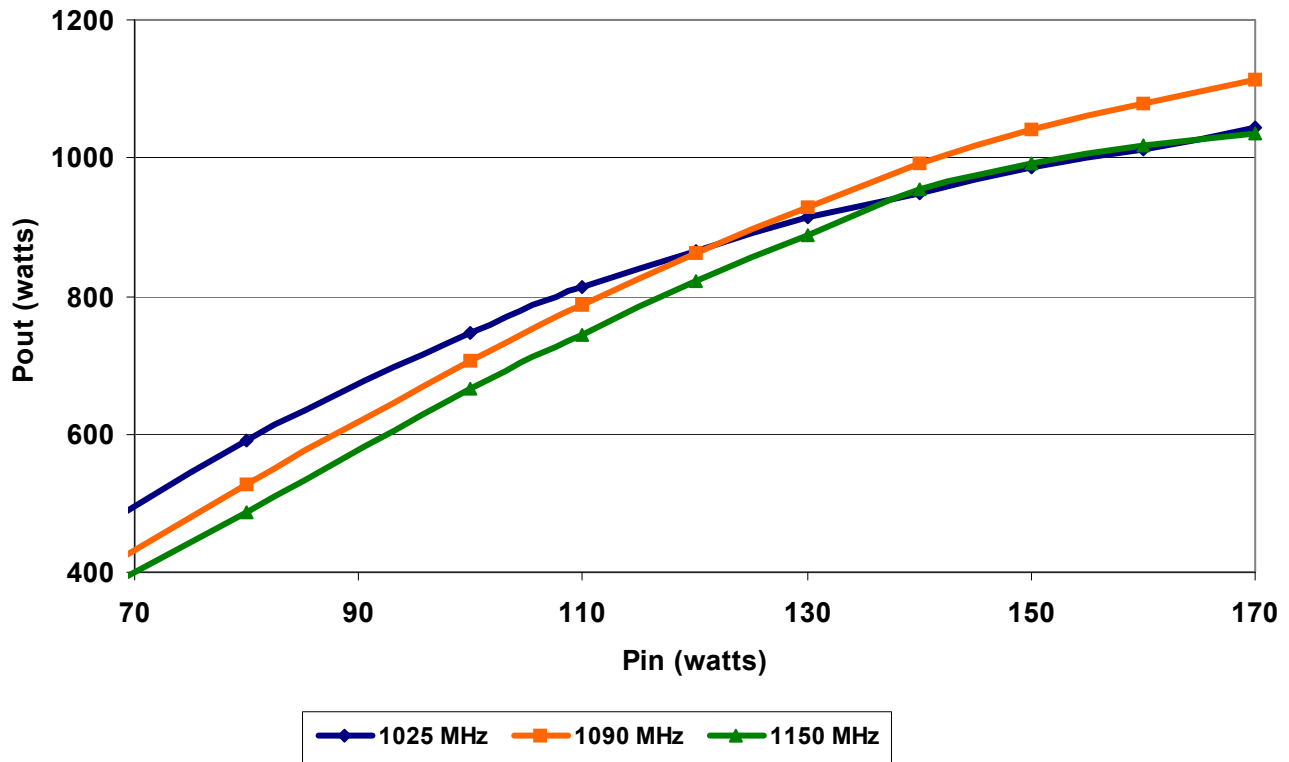

Broadband Test Fixture Impedance

F (MHz)	Z _{IF} (Ω)	Z _{OF} (Ω)
1025	1.7 - j1.8	0.8 - j1.3
1090	1.4 - j1.2	0.8 - j1.0
1150	1.3 - j0.7	0.8 - j0.8

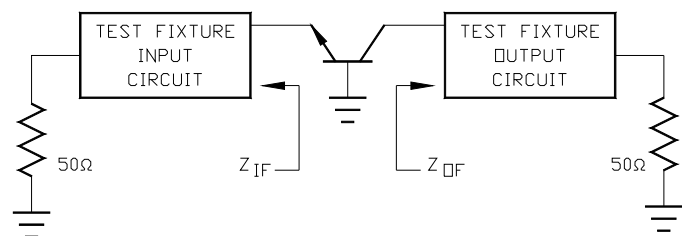

Avionics Pulsed Power Transistor
850W, 1025-1150 MHz, 10µs Pulse, 1% Duty

M/A-COM Products
Released, 30 May 07

Test Fixture Circuit Dimensions

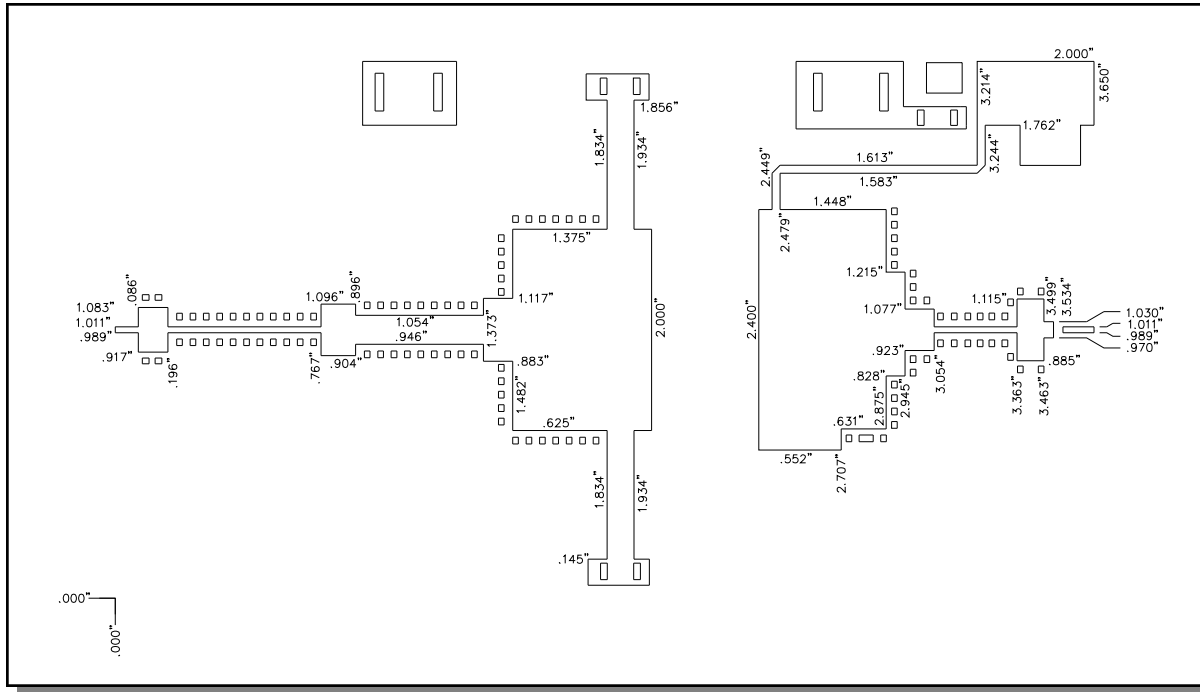

Test Fixture Assembly

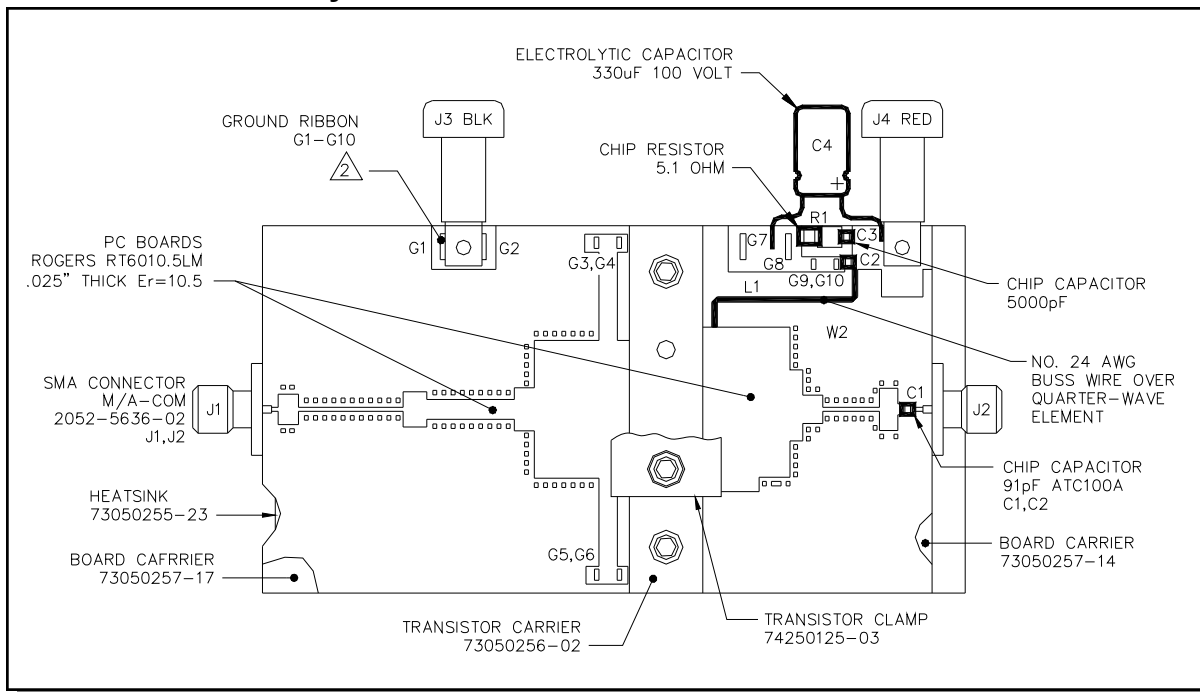

ADVANCED: Data Sheets contain information regarding a product M/A-COM Technology Solutions is considering for development. Performance is based on target specifications, simulated results, and/or prototype measurements. Commitment to develop is not guaranteed.
PRELIMINARY: Data Sheets contain information regarding a product M/A-COM Technology Solutions has under development. Performance is based on engineering tests. Specifications are typical. Mechanical outline has been fixed. Engineering samples and/or test data may be available. Commitment to produce in volume is not guaranteed.

- **North America** Tel: 800.366.2266 / Fax: 978.366.2266
- **Europe** Tel: 44.1908.574.200 / Fax: 44.1908.574.300
- **Asia/Pacific** Tel: 81.44.844.8296 / Fax: 81.44.844.8298

Visit www.macomtech.com for additional data sheets and product information.

M/A-COM Technology Solutions Inc. and its affiliates reserve the right to make changes to the product(s) or information contained herein without notice.