

Absolute maximum ratings

($T_a=25^\circ\text{C}$)

Symbol	Ratings	Unit
V_{CB0}	120	V
V_{CEO}	100	V
V_{EBO}	6	V
I_c	3	A
I_{cP}	5 (PW \leq 1ms, Du \leq 50%)	A
I_B	0.2	A
P_T	4 ($T_a=25^\circ\text{C}$)	W
	20 ($T_c=25^\circ\text{C}$)	
T_j	150	$^\circ\text{C}$
T_{stg}	-40 to +150	$^\circ\text{C}$

Electrical characteristics

($T_a=25^\circ\text{C}$)

Symbol	Specification			Unit	Conditions
	min	typ	max		
I_{cB0}			10	μA	$V_{CB}=120\text{V}$
I_{EBO}			10	mA	$V_{EB}=6\text{V}$
V_{CEO}	100			V	$I_c=25\text{mA}$
h_{FE}	2000	6000	15000		$V_{CE}=4\text{V}$, $I_c=1.5\text{A}$
$V_{CE(sat)}$		1.1	1.5	V	$I_c=1.5\text{A}$, $I_B=3\text{mA}$
$V_{BE(sat)}$		1.7	2.0	V	
t_{on}		0.5		μs	$V_{CC}\approx 30\text{V}$
t_{stg}		2.2		μs	$I_c=1.5\text{A}$
t_f		0.9		μs	$I_{B1}=-I_{B2}=3\text{mA}$
f_T		40		MHz	$V_{CE}=12\text{V}$, $I_E=-0.5\text{A}$
C_{ob}		30		pF	$V_{CB}=10\text{V}$, $f=1\text{MHz}$

Equivalent circuit diagram

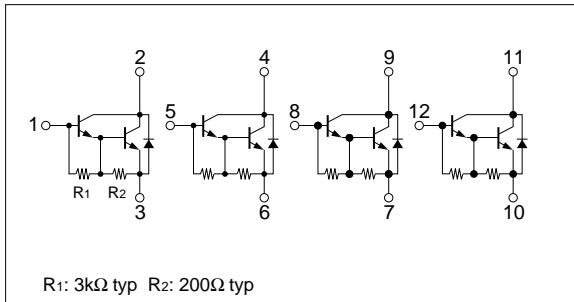

Characteristic curves

I_c - V_{CE} Characteristics (Typical)

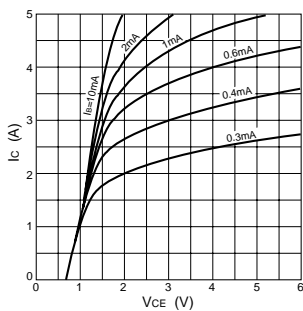

h_{FE} - I_c Characteristics (Typical)

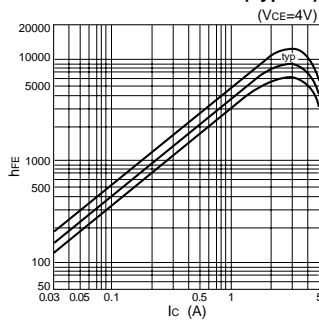

h_{FE} - I_c Temperature Characteristics (Typical)

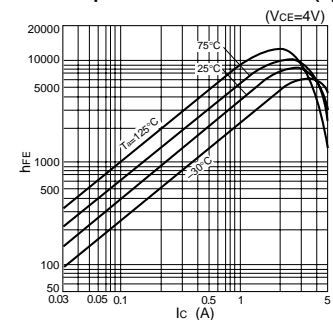

$V_{CE(sat)}$ - I_c Temperature Characteristics (Typical)

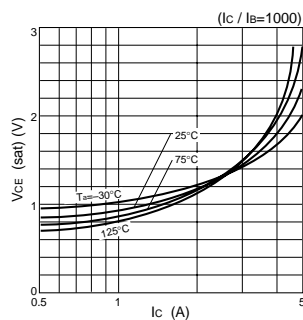

$V_{CE(sat)}$ - I_B Characteristics (Typical)

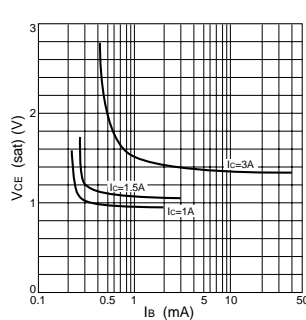

I_c - V_{BE} Temperature Characteristics (Typical)

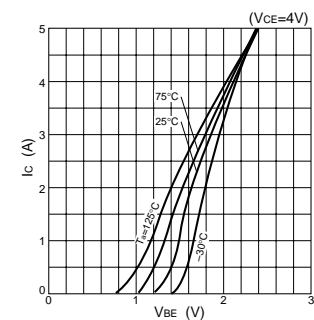

θ_{j-a} -PW Characteristics

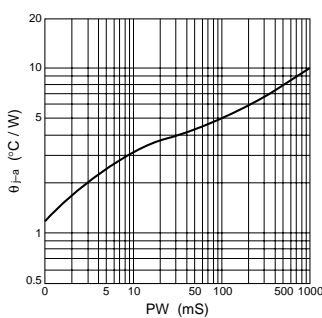

P_T - T_a Characteristics

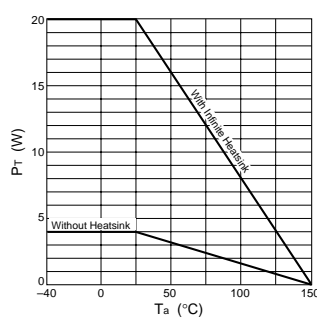

Safe Operating Area (SOA)

