

General Description

The QM2605V is the highest performance trench N-ch and P-ch MOSFETs with extreme high cell density, which provide excellent RDS(on) and gate charge for most of the small power switching and load switch applications.

The QM2605V meet the RoHS and Green Product requirement with full function reliability approved.

Features

- Advanced high cell density Trench technology
- Super Low Gate Charge
- Excellent Cdv/dt effect decline
- Green Device Available

Absolute Maximum Ratings

Symbol	Parameter	Rating				Units
		N-Channel		P-Channel		
		10s	Steady State	10s	Steady State	
V _{DS}	Drain-Source Voltage	20		-20		V
V _{GS}	Gate-Source Voltage	±8		±8		V
I _D @T _A =25°C	Continuous Drain Current, V _{GS} @ -4.5V ¹	4.3	3.8	-2.9	-2.5	A
I _D @T _A =70°C	Continuous Drain Current, V _{GS} @ -4.5V ¹	3.4	3	-2.3	-2	A
I _{DM}	Pulsed Drain Current ²	15.2		-10		A
P _D @T _A =25°C	Total Power Dissipation ³	1.5	1.1	1.5	1.1	W
T _{STG}	Storage Temperature Range	-55 to 150		-55 to 150		°C
T _J	Operating Junction Temperature Range	-55 to 150		-55 to 150		°C

Thermal Data

Symbol	Parameter	Typ.	Max.	Unit
R _{θJA}	Thermal Resistance Junction-ambient ¹	---	110	°C/W
R _{θJA}	Thermal Resistance Junction-Ambient ¹ (t ≤ 10s)	---	85	°C/W
R _{θJC}	Thermal Resistance Junction-Case ¹	---	70	°C/W

N-Ch and P-Ch Fast Switching MOSFETs

Product Summary



BVDSS	RDS(on)	ID
20V	48mΩ	3.8A
-20V	130mΩ	-2.5A

Applications

- High Frequency Point-of-Load Synchronous s
Small power switching for MB/NB/UMPC/VGA
- Networking DC-DC Power System
- Load Switch

TSOP6 Pin Configuration

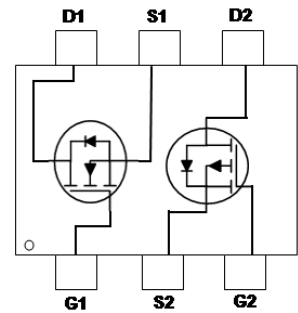
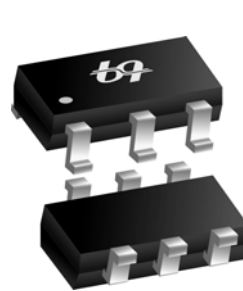

N-Ch and P-Ch Fast Switching MOSFETs
N-Channel Electrical Characteristics ($T_J=25\text{ }^\circ\text{C}$, unless otherwise noted)

Symbol	Parameter	Conditions	Min.	Typ.	Max.	Unit
BV_{DSS}	Drain-Source Breakdown Voltage	$V_{GS}=0V, I_D=250\mu A$	20	---	---	V
$\Delta BV_{DSS}/\Delta T_J$	BVDSS Temperature Coefficient	Reference to 25°C , $I_D=1\text{mA}$	---	0.024	---	V/ $^\circ\text{C}$
$R_{DS(ON)}$	Static Drain-Source On-Resistance ²	$V_{GS}=4.5V, I_D=3A$	---	40	48	m Ω
		$V_{GS}=2.5V, I_D=2A$	---	45	55	
		$V_{GS}=1.8V, I_D=1.5A$	---	55	65	
$V_{GS(th)}$	Gate Threshold Voltage	$V_{GS}=V_{DS}, I_D=250\mu A$	0.3	0.5	1	V
$\Delta V_{GS(th)}$	$V_{GS(th)}$ Temperature Coefficient		---	-2.51	---	mV/ $^\circ\text{C}$
I_{DSS}	Drain-Source Leakage Current	$V_{DS}=16V, V_{GS}=0V, T_J=25^\circ\text{C}$	---	---	1	μA
		$V_{DS}=16V, V_{GS}=0V, T_J=55^\circ\text{C}$	---	---	5	
I_{GSS}	Gate-Source Leakage Current	$V_{GS}=\pm 8V, V_{DS}=0V$	---	---	± 100	nA
gfs	Forward Transconductance	$V_{DS}=5V, I_D=3A$	---	9	---	S
R_g	Gate Resistance	$V_{DS}=0V, V_{GS}=0V, f=1\text{MHz}$	---	1.7	3.4	Ω
Q_g	Total Gate Charge (4.5V)	$V_{DS}=15V, V_{GS}=4.5V, I_D=3A$	---	6.2	8.7	nC
Q_{gs}	Gate-Source Charge		---	0.36	0.5	
Q_{gd}	Gate-Drain Charge		---	1.56	2.18	
$T_{d(on)}$	Turn-On Delay Time	$V_{DD}=10V, V_{GS}=4.5V, R_G=3.3\Omega, I_D=3A$	---	1.4	2.8	ns
T_r	Rise Time		---	40	72.0	
$T_{d(off)}$	Turn-Off Delay Time		---	17	34	
T_f	Fall Time		---	5.6	11.2	
C_{iss}	Input Capacitance	$V_{DS}=15V, V_{GS}=0V, f=1\text{MHz}$	---	382	534.8	pF
C_{oss}	Output Capacitance		---	41	57.4	
C_{rss}	Reverse Transfer Capacitance		---	33	46.2	

Diode Characteristics

Symbol	Parameter	Conditions	Min.	Typ.	Max.	Unit
I_S	Continuous Source Current ^{1,4}	$V_G=V_D=0V$, Force Current	---	---	3.8	A
I_{SM}	Pulsed Source Current ^{2,4}		---	---	15.2	A
V_{SD}	Diode Forward Voltage ²	$V_{GS}=0V, I_S=1A, T_J=25^\circ\text{C}$	---	---	1.2	V
t_{rr}	Reverse Recovery Time	$I_F=3A, di/dt=100A/\mu s, T_J=25^\circ\text{C}$	---	5.7	---	nS
Q_{rr}	Reverse Recovery Charge		---	1.8	---	nC

Note :

- 1.The data tested by surface mounted on a 1 inch² FR-4 board with 20Z copper.
- 2.The data tested by pulsed , pulse width $\leq 300\mu s$, duty cycle $\leq 2\%$
- 3.The power dissipation is limited by 150°C junction temperature
- 4.The data is theoretically the same as I_D and I_{DM} , in real applications , should be limited by total power dissipation.

N-Ch and P-Ch Fast Switching MOSFETs

N-Channel Typical Characteristics

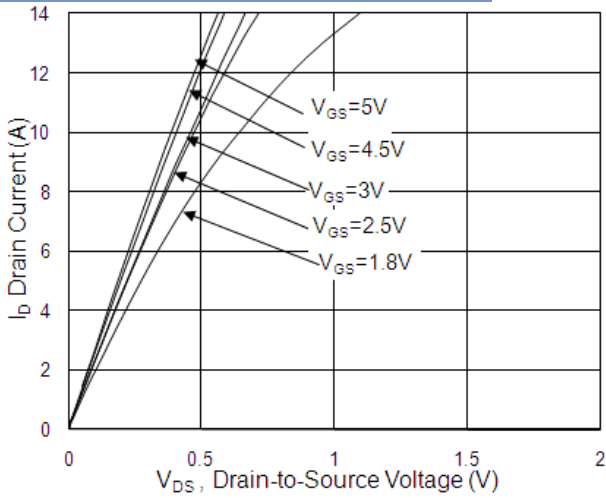

Fig.1 Typical Output Characteristics

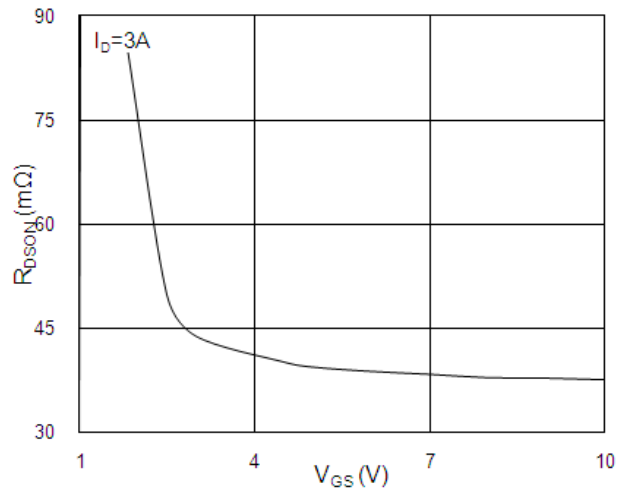

Fig.2 On-Resistance vs. Gate-Source

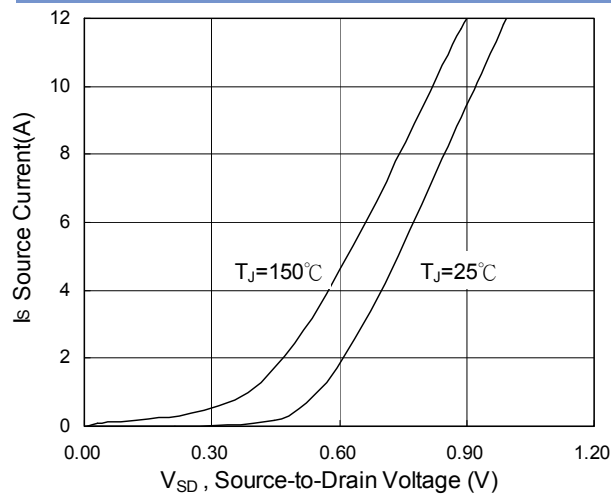

Fig.3 Forward Characteristics Of Reverse

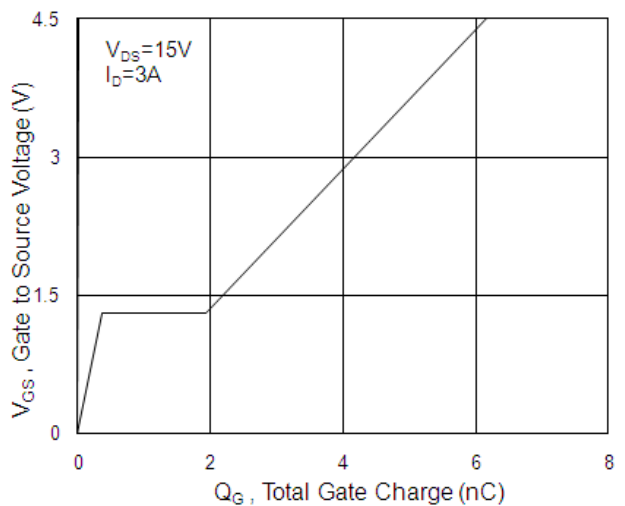

Fig.4 Gate-Charge Characteristics

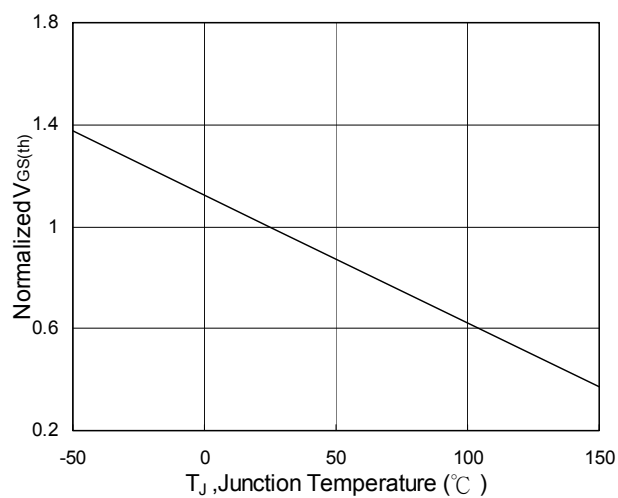

Fig.5 Normalized $V_{GS(th)}$ vs. T_J

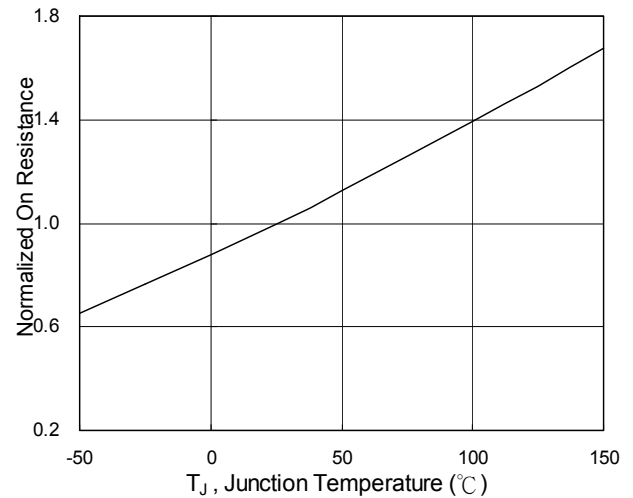

Fig.6 Normalized $R_{DS(on)}$ vs. T_J

N-Ch and P-Ch Fast Switching MOSFETs

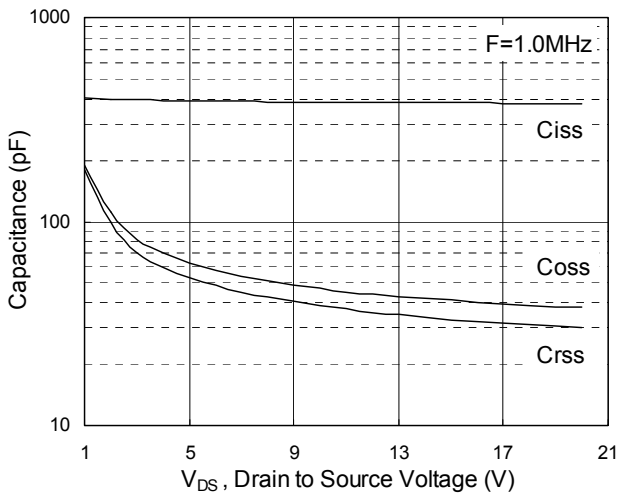

Fig.7 Capacitance

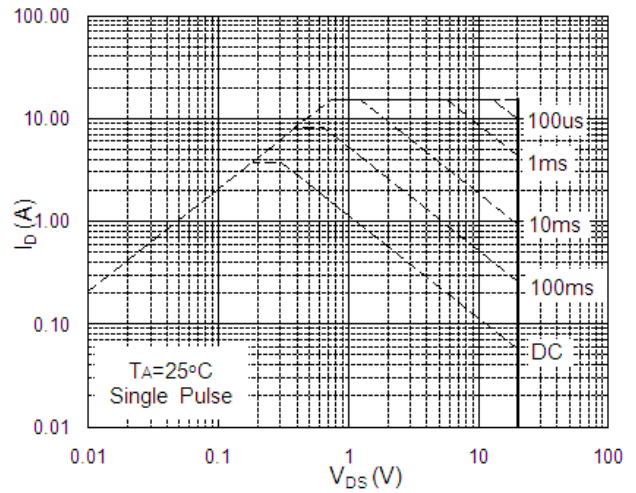

Fig.8 Safe Operating Area

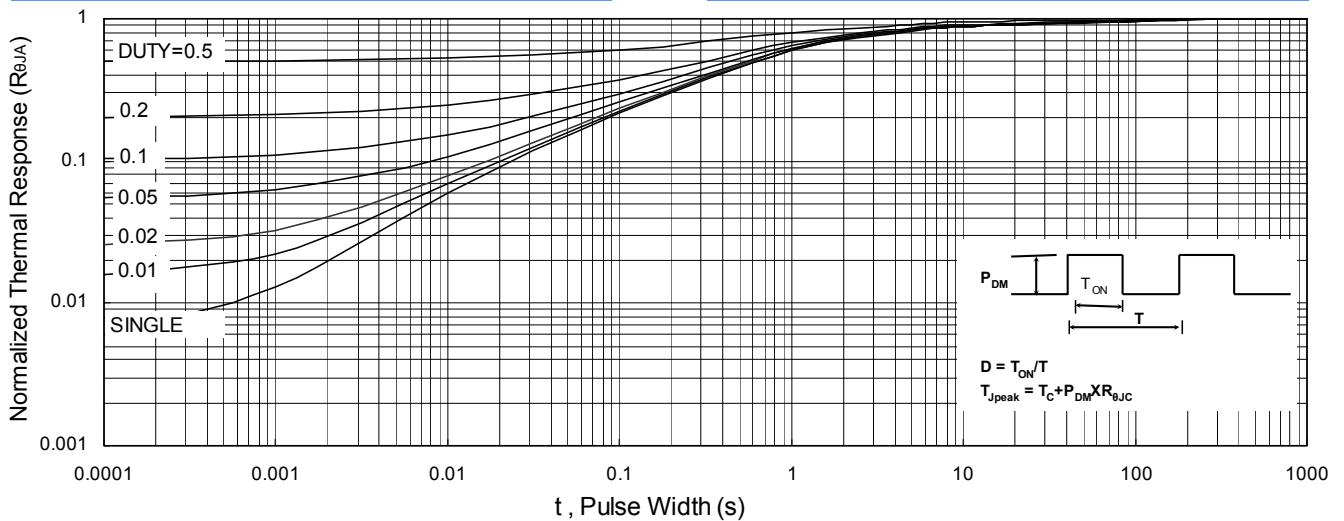

Fig.9 Normalized Maximum Transient Thermal Impedance

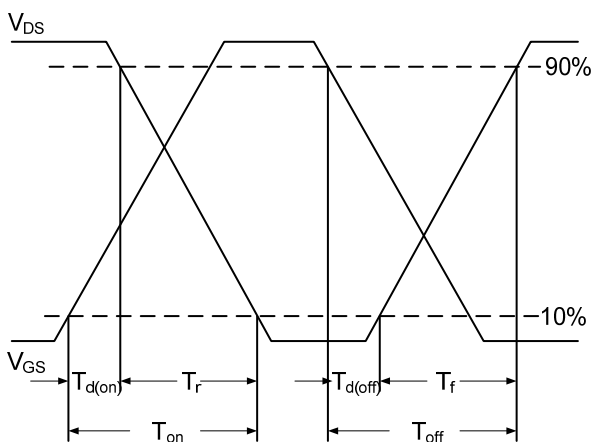

Fig.10 Switching Time Waveform

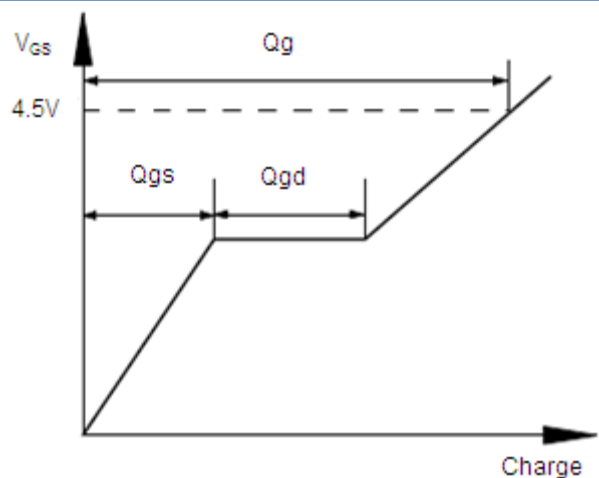

Fig.11 Gate Charge Waveform

N-Ch and P-Ch Fast Switching MOSFETs
P-Channel Electrical Characteristics (T_J=25 °C, unless otherwise noted)

Symbol	Parameter	Conditions	Min.	Typ.	Max.	Unit
BV _{DSS}	Drain-Source Breakdown Voltage	V _{GS} =0V, I _D =-250uA	-20	---	---	V
ΔBV _{DSS} /ΔT _J	BVDSS Temperature Coefficient	Reference to 25°C, I _D =-1mA	---	-0.016	---	V/°C
R _{DS(ON)}	Static Drain-Source On-Resistance ²	V _{GS} =-4.5V, I _D =-2.5A	---	105	130	mΩ
		V _{GS} =-2.5V, I _D =-1.5A	---	145	170	
		V _{GS} =-1.8V, I _D =-1A	---	185	220	
V _{GS(th)}	Gate Threshold Voltage	V _{GS} =V _{DS} , I _D =-250uA	-0.3	-0.5	-1	V
ΔV _{GS(th)}	V _{GS(th)} Temperature Coefficient		---	3.97	---	mV/°C
I _{DSS}	Drain-Source Leakage Current	V _{DS} =-16V, V _{GS} =0V, T _J =25°C	---	---	-1	uA
		V _{DS} =-16V, V _{GS} =0V, T _J =55°C	---	---	-5	
I _{GSS}	Gate-Source Leakage Current	V _{GS} =±8V, V _{DS} =0V	---	---	±100	nA
g _{fs}	Forward Transconductance	V _{DS} =-5V, I _D =-2A	---	5.9	---	S
R _g	Gate Resistance	V _{DS} =0V, V _{GS} =0V, f=1MHz	---	13.1	26.2	Ω
Q _g	Total Gate Charge (-4.5V)	V _{DS} =-15V, V _{GS} =-4.5V, I _D =-2A	---	5.6	7.8	nC
Q _{gs}	Gate-Source Charge		---	0.72	1.0	
Q _{gd}	Gate-Drain Charge		---	1.45	2.0	
T _{d(on)}	Turn-On Delay Time	V _{DD} =-15V, V _{GS} =-4.5V, R _G =3.3Ω I _D =-2A	---	4	8.0	ns
T _r	Rise Time		---	25.6	46	
T _{d(off)}	Turn-Off Delay Time		---	26	52	
T _f	Fall Time		---	12.4	24.8	
C _{iss}	Input Capacitance	V _{DS} =-15V, V _{GS} =0V, f=1MHz	---	332	465	pF
C _{oss}	Output Capacitance		---	48	67	
C _{rss}	Reverse Transfer Capacitance		---	42	59	

Diode Characteristics

Symbol	Parameter	Conditions	Min.	Typ.	Max.	Unit
I _S	Continuous Source Current ^{1,4}	V _G =V _D =0V, Force Current	---	---	-2.5	A
I _{SM}	Pulsed Source Current ^{2,4}		---	---	-10	A
V _{SD}	Diode Forward Voltage ²	V _{GS} =0V, I _S =-1A, T _J =25°C	---	---	-1.2	V
t _{rr}	Reverse Recovery Time	I _F =-2A, dI/dt=100A/μs, T _J =25°C	---	23	---	nS
Q _{rr}	Reverse Recovery Charge		---	4.7	---	nC

Note :

- 1.The data tested by surface mounted on a 1 inch² FR-4 board with 20Z copper.
- 2.The data tested by pulsed, pulse width ≤ 300us, duty cycle ≤ 2%
- 3.The power dissipation is limited by 150°C junction temperature
- 4.The data is theoretically the same as I_D and I_{DM}, in real applications, should be limited by total power dissipation.

N-Ch and P-Ch Fast Switching MOSFETs

P-Channel Typical Characteristics

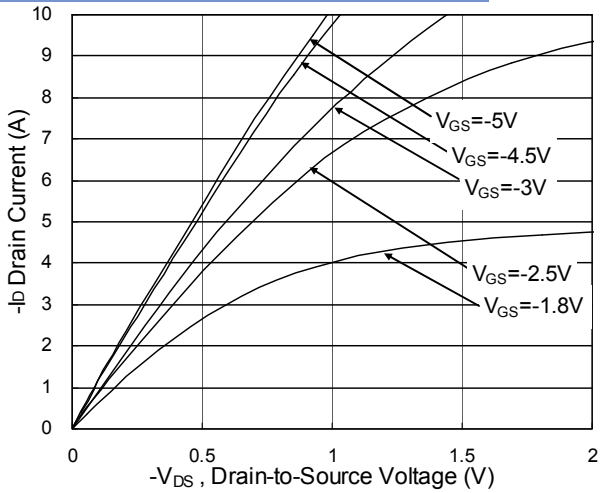

Fig.1 Typical Output Characteristics

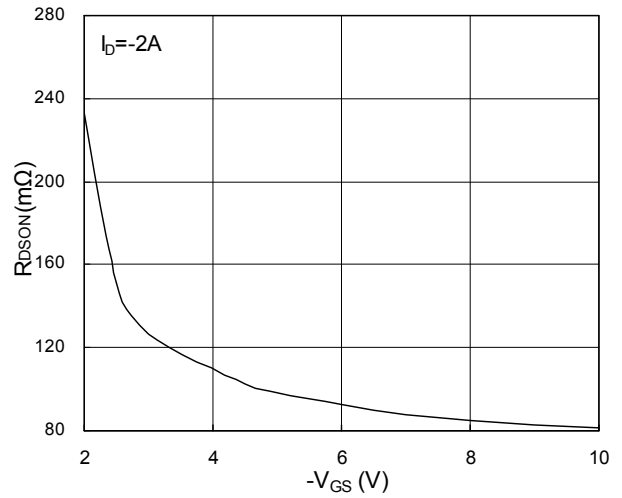

Fig.2 On-Resistance vs. Gate-Source

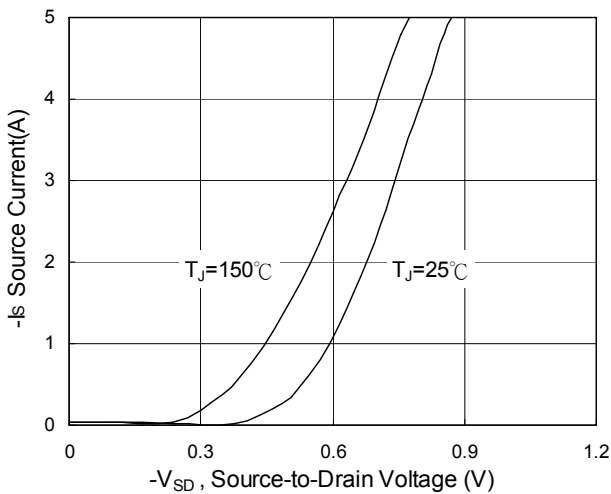

Fig.3 Forward Characteristics Of Reverse

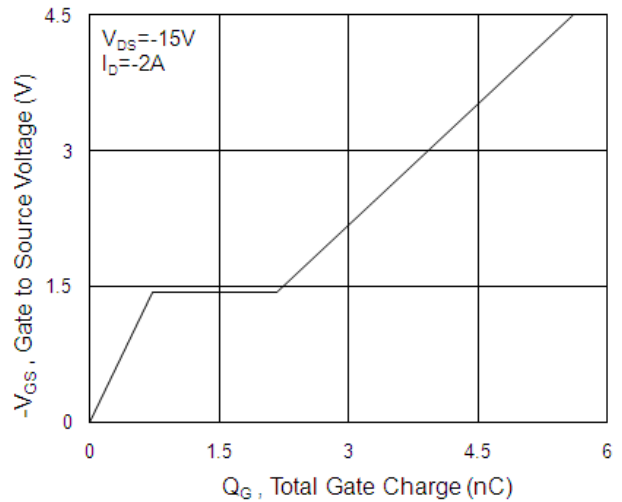

Fig.4 Gate-Charge Characteristics

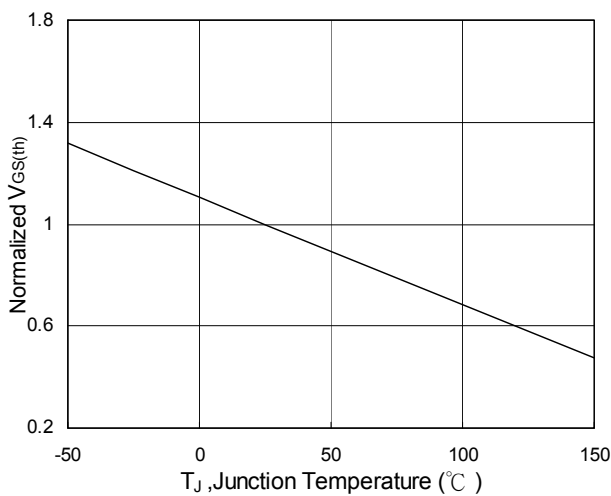

Fig.5 Normalized $V_{GS(th)}$ vs. T_J

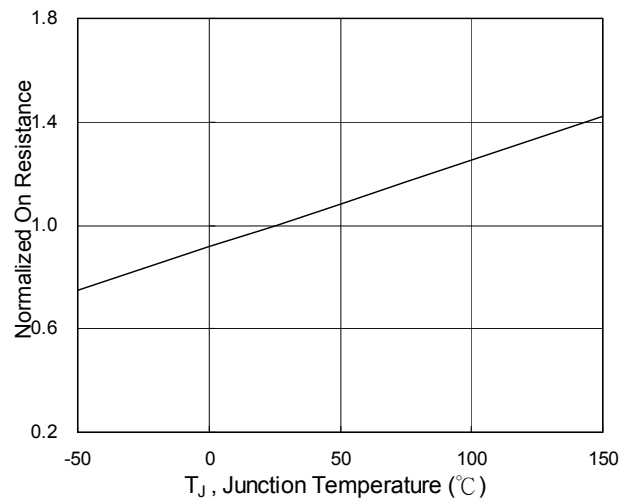

Fig.6 Normalized $R_{DS(on)}$ vs. T_J

N-Ch and P-Ch Fast Switching MOSFETs

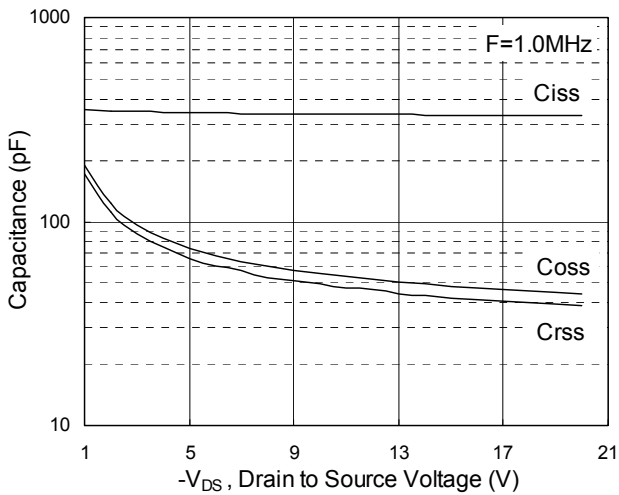

Fig.7 Capacitance

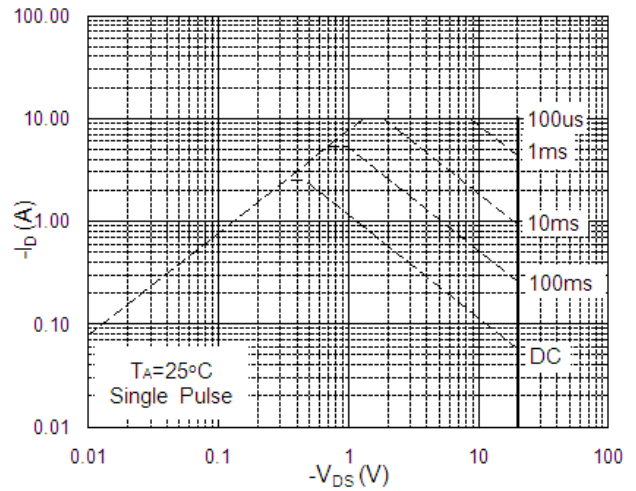

Fig.8 Safe Operating Area

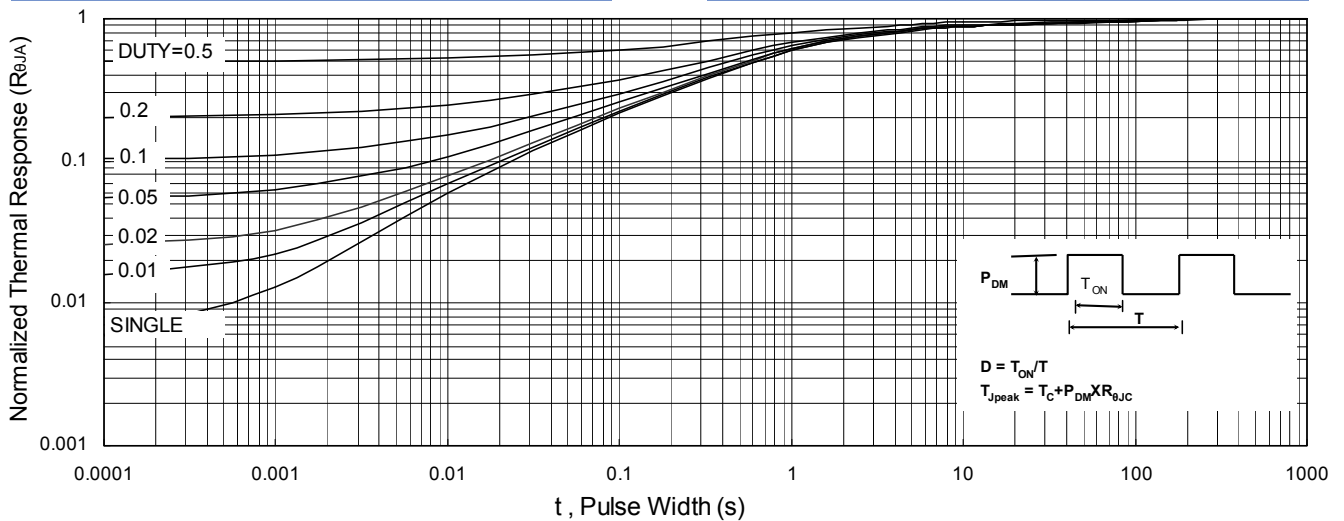

Fig.9 Normalized Maximum Transient Thermal Impedance

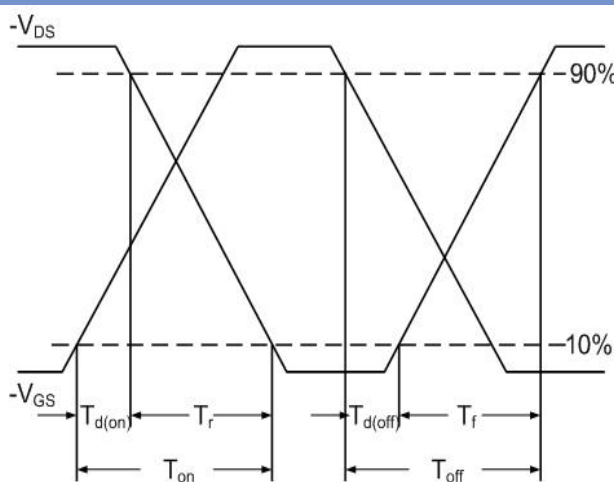

Fig.10 Switching Time Waveform

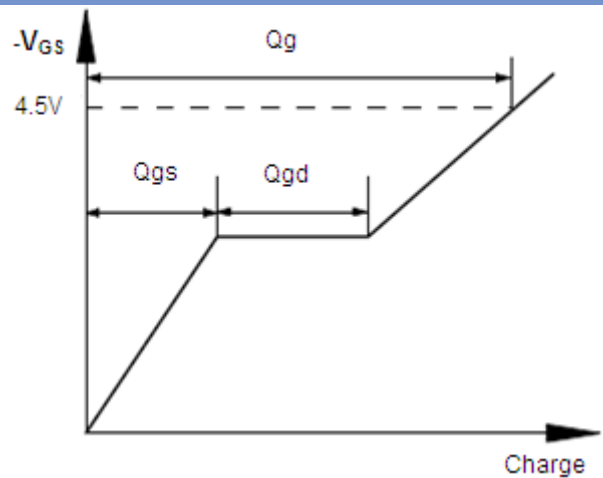

Fig.11 Gate Charge Waveform