

## N-Ch and P-Ch Fast Switching MOSFETs

### General Description

The QM4803D is the highest performance trench N-ch and P-ch MOSFETs with extreme high cell density, which provide excellent R<sub>DS(on)</sub> and gate charge for most of the synchronous buck converter applications.

The QM4803D meet the RoHS and Green Product requirement 100% EAS guaranteed with full function reliability approved.

### Features

- Advanced high cell density Trench technology
- Super Low Gate Charge
- Excellent CdV/dt effect decline
- 100% EAS Guaranteed
- Green Device Available

### Absolute Maximum Ratings

Symbol	Parameter	Rating		Units
		N-Ch	P-Ch	
V <sub>DS</sub>	Drain-Source Voltage	40	-40	V
V <sub>GS</sub>	Gate-Source Voltage	±20	±20	V
I <sub>D</sub> @T <sub>C</sub> =25°C	Continuous Drain Current, V <sub>GS</sub> @ 10V <sup>1</sup>	23	-20	A
I <sub>D</sub> @T <sub>C</sub> =100°C	Continuous Drain Current, V <sub>GS</sub> @ 10V <sup>1</sup>	18	-16	A
I <sub>DM</sub>	Pulsed Drain Current <sup>2</sup>	46	-40	A
EAS	Single Pulse Avalanche Energy <sup>3</sup>	28	66	mJ
I <sub>AS</sub>	Avalanche Current	17.8	-27.2	A
P <sub>D</sub> @T <sub>C</sub> =25°C	Total Power Dissipation <sup>4</sup>	25	31.3	W
T <sub>STG</sub>	Storage Temperature Range	-55 to 150	-55 to 150	°C
T <sub>J</sub>	Operating Junction Temperature Range	-55 to 150	-55 to 150	°C

### Thermal Data

Symbol	Parameter	Typ.	Max.	Unit
R <sub>θJA</sub>	Thermal Resistance Junction-Ambient <sup>1</sup>	---	62	°C/W
R <sub>θJC</sub>	Thermal Resistance Junction-Case <sup>1</sup>	---	5	°C/W

### Product Summary



BVDSS	R <sub>DS(on)</sub>	I <sub>D</sub>
40V	26mΩ	23A
-40V	40mΩ	-20A

### Applications

- High Frequency Point-of-Load Synchronous Buck Converter for MB/NB/UMPC/VGA
- Networking DC-DC Power System
- CCFL Back-light Inverter

### TO252 Pin Configuration

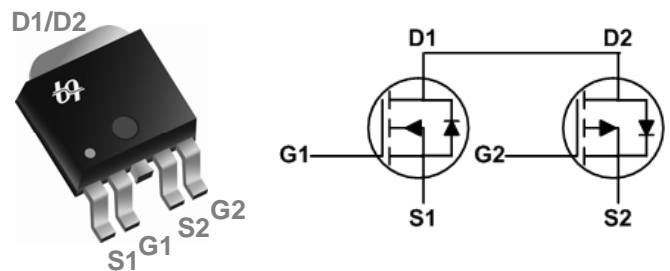

**N-Ch and P-Ch Fast Switching MOSFETs**
**N-Channel Electrical Characteristics ( $T_J=25\text{ }^\circ\text{C}$ , unless otherwise noted)**

Symbol	Parameter	Conditions	Min.	Typ.	Max.	Unit
$BV_{DSS}$	Drain-Source Breakdown Voltage	$V_{GS}=0V, I_D=250\mu A$	40	---	---	V
$\Delta BV_{DSS}/\Delta T_J$	BVDSS Temperature Coefficient	Reference to $25^\circ\text{C}$ , $I_D=1\text{mA}$	---	0.034	---	V/ $^\circ\text{C}$
$R_{DS(ON)}$	Static Drain-Source On-Resistance <sup>2</sup>	$V_{GS}=10V, I_D=12A$	---	22	26	m $\Omega$
		$V_{GS}=4.5V, I_D=10A$	---	28	35	
$V_{GS(th)}$	Gate Threshold Voltage	$V_{GS}=V_{DS}, I_D=250\mu A$	1.0	1.5	2.5	V
$\Delta V_{GS(th)}$	$V_{GS(th)}$ Temperature Coefficient		---	-4.56	---	mV/ $^\circ\text{C}$
$I_{DSS}$	Drain-Source Leakage Current	$V_{DS}=32V, V_{GS}=0V, T_J=25^\circ\text{C}$	---	---	1	$\mu\text{A}$
		$V_{DS}=32V, V_{GS}=0V, T_J=55^\circ\text{C}$	---	---	5	
$I_{GSS}$	Gate-Source Leakage Current	$V_{GS}=\pm 20V, V_{DS}=0V$	---	---	$\pm 100$	nA
$g_{fs}$	Forward Transconductance	$V_{DS}=5V, I_D=12A$	---	8	---	S
$R_g$	Gate Resistance	$V_{DS}=0V, V_{GS}=0V, f=1\text{MHz}$	---	2.6	5.2	$\Omega$
$Q_g$	Total Gate Charge (4.5V)	$V_{DS}=20V, V_{GS}=4.5V, I_D=12A$	---	5.5	---	nC
$Q_{gs}$	Gate-Source Charge		---	1.25	---	
$Q_{gd}$	Gate-Drain Charge		---	2.5	---	
$T_{d(on)}$	Turn-On Delay Time	$V_{DD}=20V, V_{GS}=10V, R_G=3.3\Omega$ $I_D=1A$	---	8.9	---	ns
$T_r$	Rise Time		---	2.2	---	
$T_{d(off)}$	Turn-Off Delay Time		---	41	---	
$T_f$	Fall Time		---	2.7	---	
$C_{iss}$	Input Capacitance	$V_{DS}=15V, V_{GS}=0V, f=1\text{MHz}$	---	593	---	pF
$C_{oss}$	Output Capacitance		---	76	---	
$C_{riss}$	Reverse Transfer Capacitance		---	56	---	

**Guaranteed Avalanche Characteristics**

Symbol	Parameter	Conditions	Min.	Typ.	Max.	Unit
EAS	Single Pulse Avalanche Energy <sup>5</sup>	$V_{DD}=25V, L=0.1\text{mH}, I_{AS}=10A$	9	---	---	mJ

**Diode Characteristics**

Symbol	Parameter	Conditions	Min.	Typ.	Max.	Unit
$I_S$	Continuous Source Current <sup>1,6</sup>	$V_G=V_D=0V$ , Force Current	---	---	23	A
$I_{SM}$	Pulsed Source Current <sup>2,6</sup>		---	---	46	A
$V_{SD}$	Diode Forward Voltage <sup>2</sup>	$V_{GS}=0V, I_S=1A, T_J=25^\circ\text{C}$	---	---	1.2	V

Note :

- The data tested by surface mounted on a 1 inch<sup>2</sup> FR-4 board with 20Z copper.
- The data tested by pulsed, pulse width  $\leq 300\mu\text{s}$ , duty cycle  $\leq 2\%$
- The EAS data shows Max. rating. The test condition is  $V_{DD}=25V, V_{GS}=10V, L=0.1\text{mH}, I_{AS}=17.8A$
- The power dissipation is limited by  $150^\circ\text{C}$  junction temperature
- The Min. value is 100% EAS tested guarantee.
- The data is theoretically the same as  $I_D$  and  $I_{DM}$ , in real applications, should be limited by total power dissipation.

### P-Channel Electrical Characteristics ( $T_J=25\text{ }^\circ\text{C}$ , unless otherwise noted)

Symbol	Parameter	Conditions	Min.	Typ.	Max.	Unit
$BV_{DSS}$	Drain-Source Breakdown Voltage	$V_{GS}=0V, I_D=-250\mu A$	-40	---	---	V
$\Delta BV_{DSS}/\Delta T_J$	$BV_{DSS}$ Temperature Coefficient	Reference to $25\text{ }^\circ\text{C}$ , $I_D=-1mA$	---	-0.012	---	V/ $^\circ\text{C}$
$R_{DS(ON)}$	Static Drain-Source On-Resistance <sup>2</sup>	$V_{GS}=-10V, I_D=-8A$	---	32	40	m $\Omega$
		$V_{GS}=-4.5V, I_D=-4A$	---	52	65	
$V_{GS(th)}$	Gate Threshold Voltage	$V_{GS}=V_{DS}, I_D=-250\mu A$	-1.0	-1.6	-2.5	V
$\Delta V_{GS(th)}$	$V_{GS(th)}$ Temperature Coefficient		---	4.32	---	mV/ $^\circ\text{C}$
$I_{DSS}$	Drain-Source Leakage Current	$V_{DS}=-32V, V_{GS}=0V, T_J=25\text{ }^\circ\text{C}$	---	---	1	$\mu A$
		$V_{DS}=-32V, V_{GS}=0V, T_J=55\text{ }^\circ\text{C}$	---	---	5	
$I_{GSS}$	Gate-Source Leakage Current	$V_{GS}=\pm 20V, V_{DS}=0V$	---	---	$\pm 100$	nA
gfs	Forward Transconductance	$V_{DS}=-5V, I_D=-8A$	---	12.6	---	S
$R_g$	Gate Resistance	$V_{DS}=0V, V_{GS}=0V, f=1MHz$	---	13	16	$\Omega$
$Q_g$	Total Gate Charge (-4.5V)	$V_{DS}=-20V, V_{GS}=-4.5V, I_D=-12A$	---	9	---	nC
$Q_{gs}$	Gate-Source Charge		---	2.54	---	
$Q_{gd}$	Gate-Drain Charge		---	3.1	---	
$T_{d(on)}$	Turn-On Delay Time	$V_{DD}=-15V, V_{GS}=-10V, R_G=3.3\Omega, I_D=-1A$	---	19.2	---	ns
$T_r$	Rise Time		---	12.8	---	
$T_{d(off)}$	Turn-Off Delay Time		---	48.6	---	
$T_f$	Fall Time		---	4.6	---	
$C_{iss}$	Input Capacitance	$V_{DS}=-15V, V_{GS}=0V, f=1MHz$	---	1004	---	pF
$C_{oss}$	Output Capacitance		---	108	---	
$C_{rss}$	Reverse Transfer Capacitance		---	80	---	

### Guaranteed Avalanche Characteristics

Symbol	Parameter	Conditions	Min.	Typ.	Max.	Unit
EAS	Single Pulse Avalanche Energy <sup>5</sup>	$V_{DD}=-25V, L=0.1mH, I_{AS}=-15A$	20	---	---	mJ

### Diode Characteristics

Symbol	Parameter	Conditions	Min.	Typ.	Max.	Unit
$I_S$	Continuous Source Current <sup>1,6</sup>	$V_G=V_D=0V$ , Force Current	---	---	-20	A
$I_{SM}$	Pulsed Source Current <sup>2,6</sup>		---	---	-40	A
$V_{SD}$	Diode Forward Voltage <sup>2</sup>	$V_{GS}=0V, I_S=-1A, T_J=25\text{ }^\circ\text{C}$	---	---	-1	V

Note :

- The data tested by surface mounted on a 1 inch<sup>2</sup> FR-4 board with 20Z copper.
- The data tested by pulsed, pulse width  $\leq 300\mu s$ , duty cycle  $\leq 2\%$
- The EAS data shows Max. rating. The test condition is  $V_{DD}=-25V, V_{GS}=-10V, L=0.1mH, I_{AS}=-27.2A$
- The power dissipation is limited by  $150\text{ }^\circ\text{C}$  junction temperature
- The Min. value is 100% EAS tested guarantee.
- The data is theoretically the same as  $I_D$  and  $I_{DM}$ , in real applications, should be limited by total power dissipation.

## N-Ch and P-Ch Fast Switching MOSFETs

### N-Channel Typical Characteristics

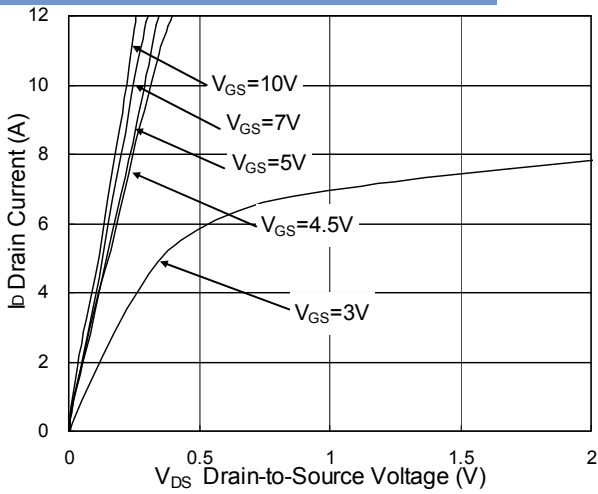

Fig.1 Typical Output Characteristics

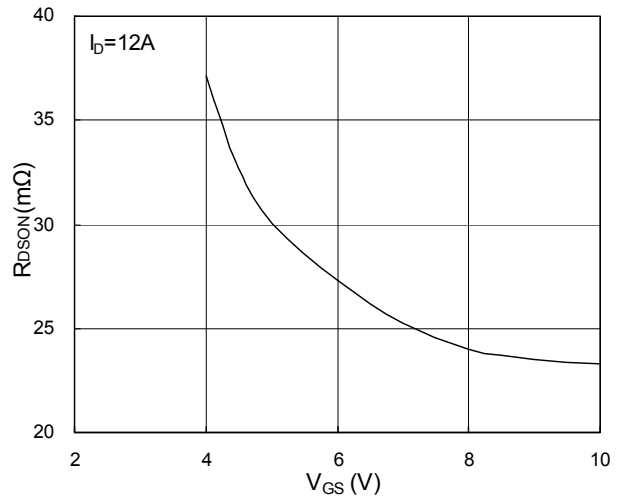

Fig.2 On-Resistance vs. G-S Voltage

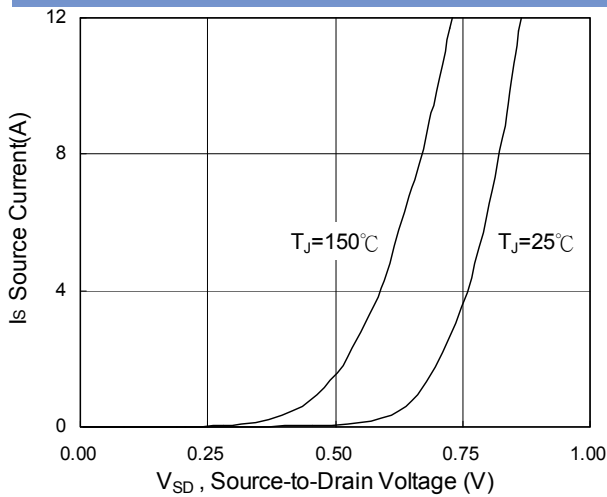

Fig.3 Forward Characteristics of Reverse

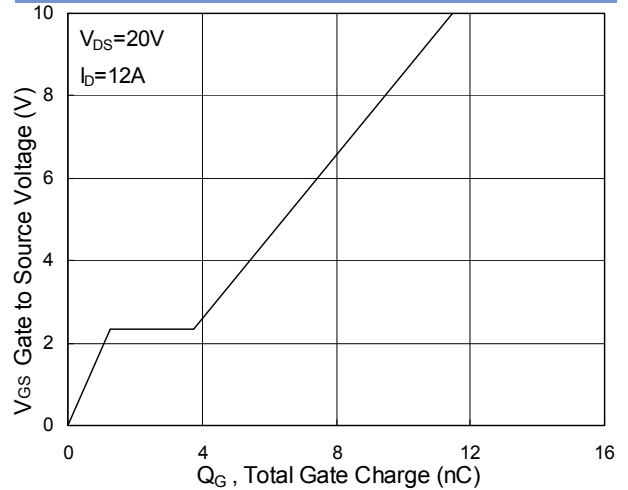

Fig.4 Gate-Charge Characteristics

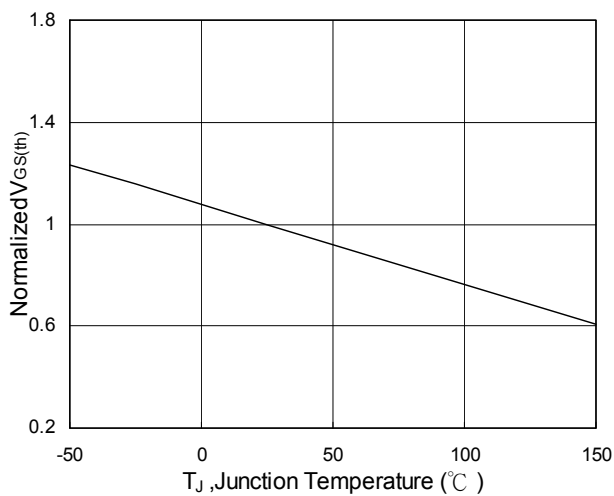

Fig.5 Normalized V<sub>GS(th)</sub> vs. T<sub>J</sub>

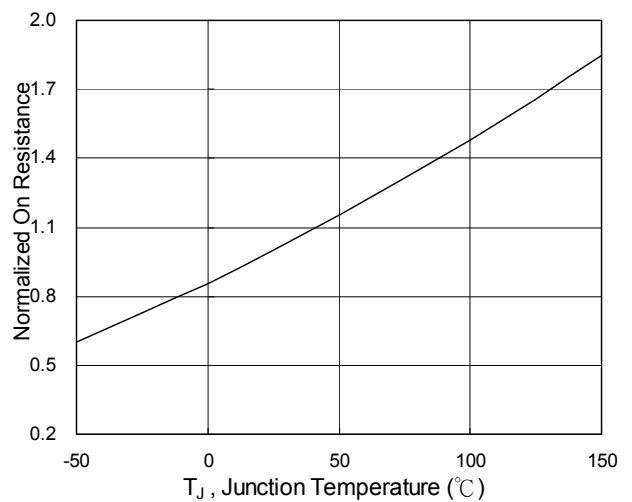

Fig.6 Normalized R<sub>DS(on)</sub> vs. T<sub>J</sub>

## N-Ch and P-Ch Fast Switching MOSFETs

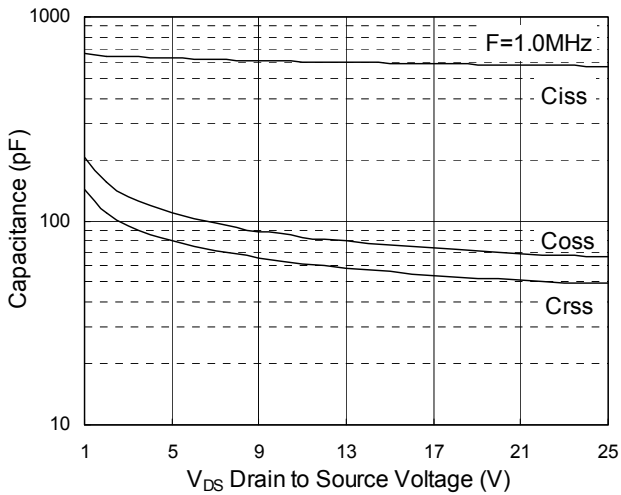

Fig.7 Capacitance

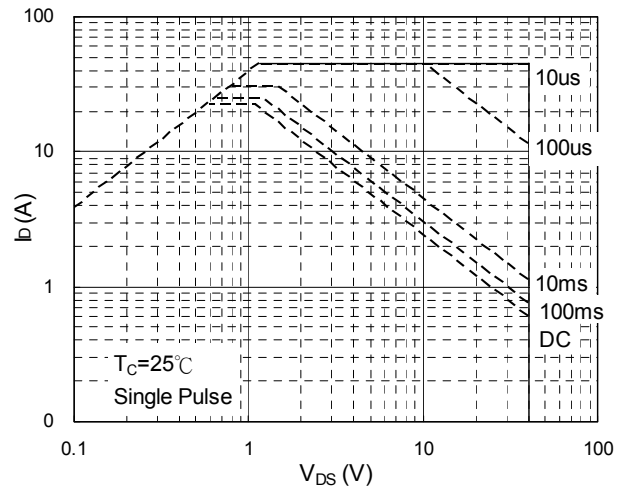

Fig.8 Safe Operating Area

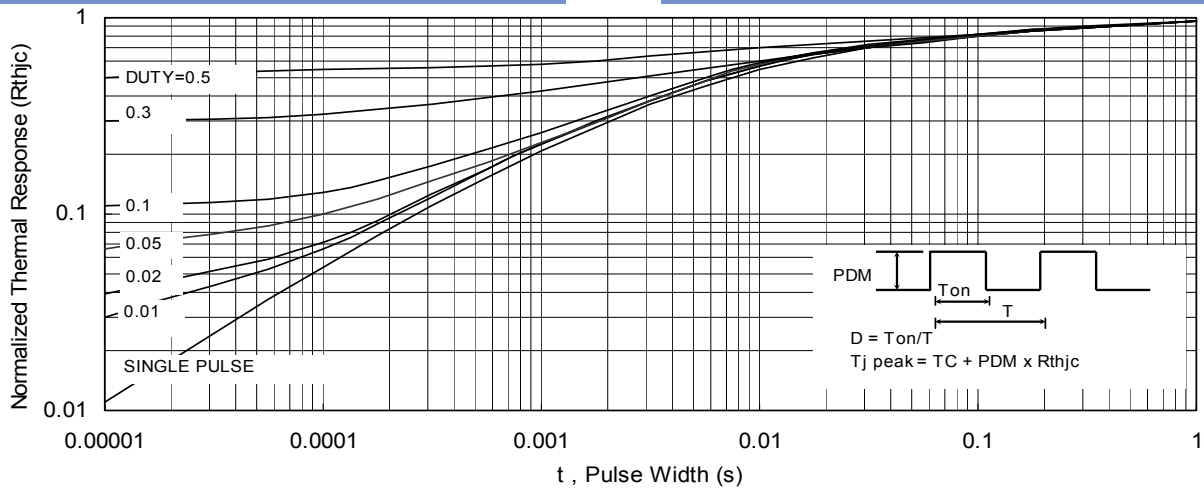

Fig.9 Normalized Maximum Transient Thermal Impedance

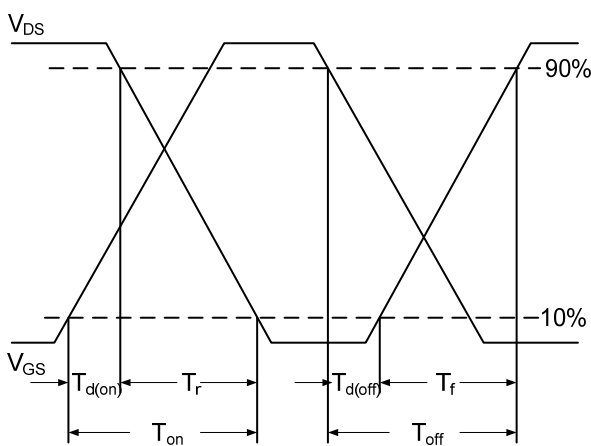

Fig.10 Switching Time Waveform

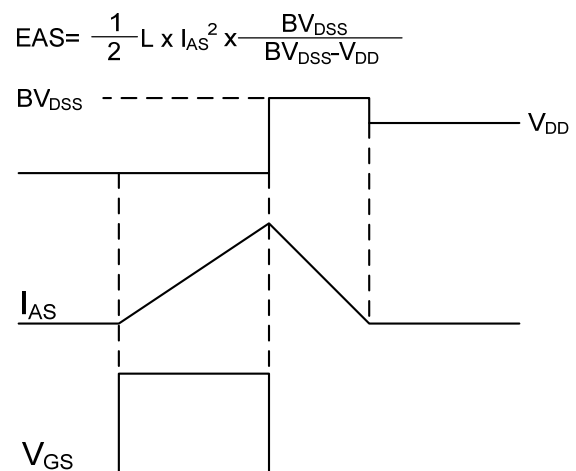

Fig.11 Unclamped Inductive Switching Wave

## N-Ch and P-Ch Fast Switching MOSFETs

### P-Channel Typical Characteristics

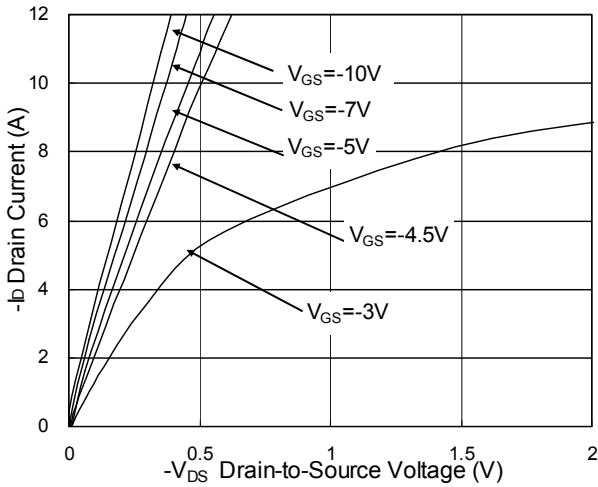

Fig.1 Typical Output Characteristics

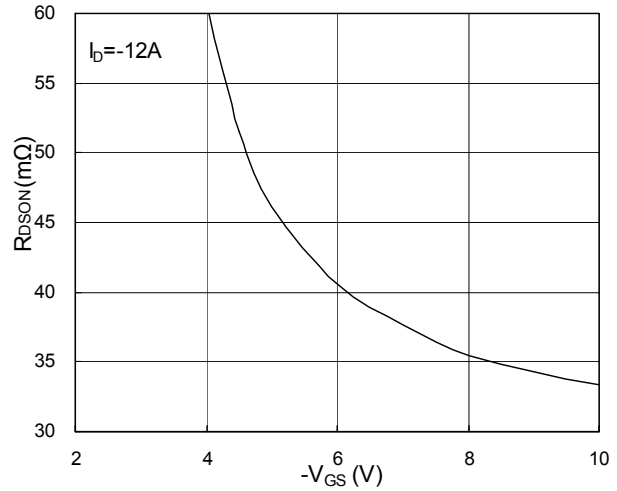

Fig.2 On-Resistance v.s Gate-Source

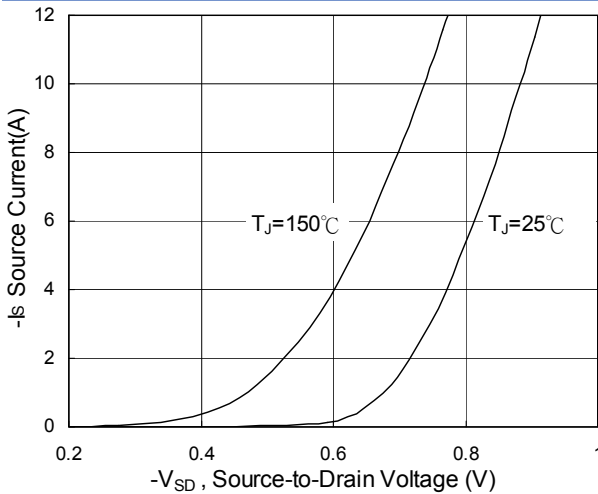

Fig.3 Forward Characteristics of Reverse

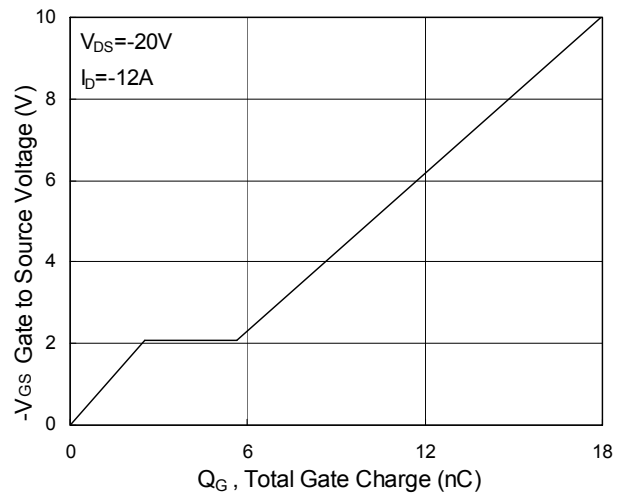

Fig.4 Gate-Charge Characteristics

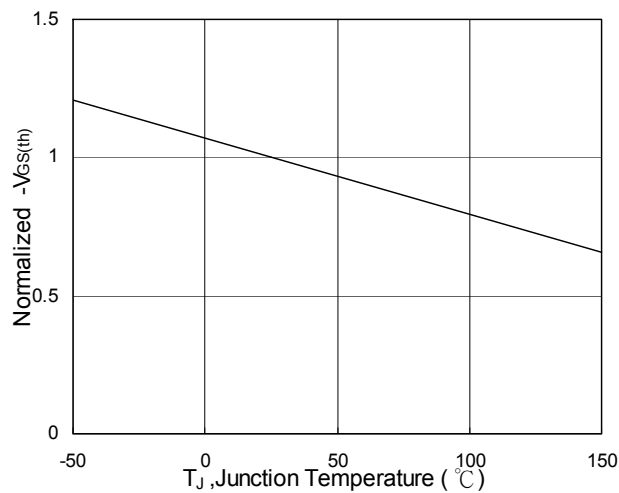

Fig.5 Normalized  $V_{GS(th)}$  v.s  $T_J$

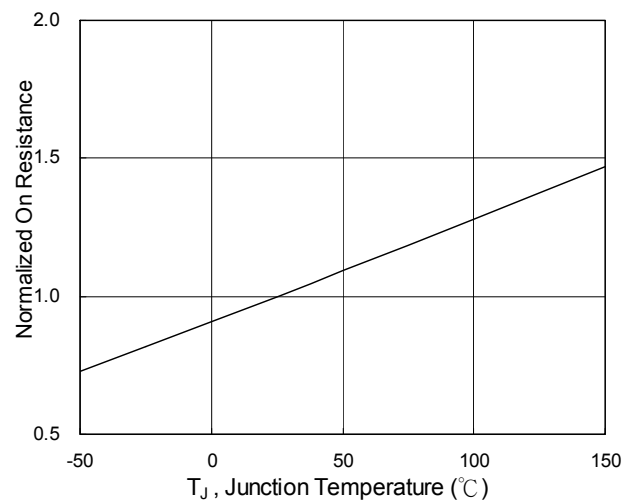

Fig.6 Normalized  $R_{DS(on)}$  v.s  $T_J$

## N-Ch and P-Ch Fast Switching MOSFETs

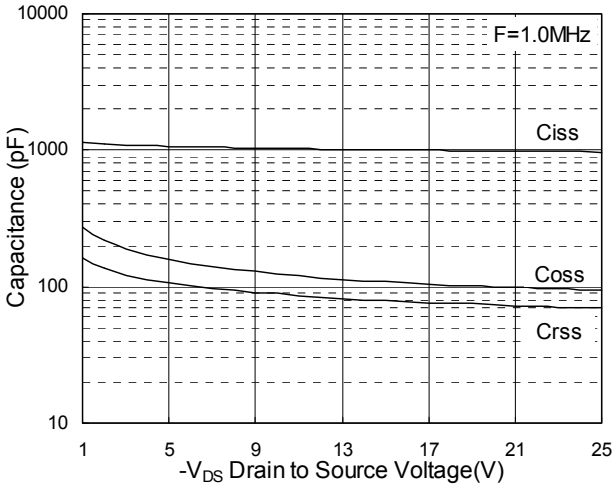

Fig.7 Capacitance

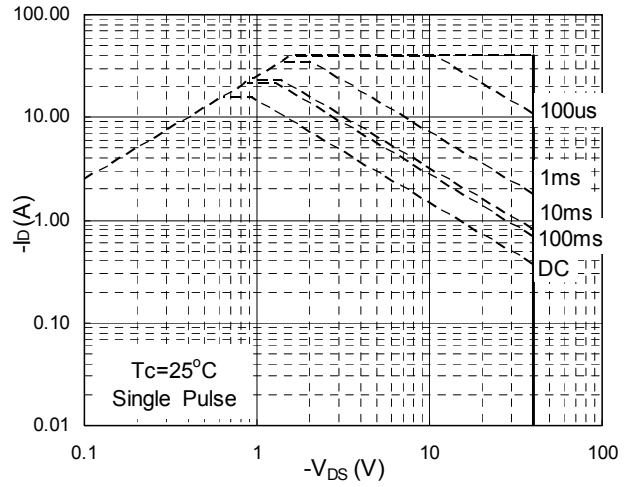

Fig.8 Safe Operating Area

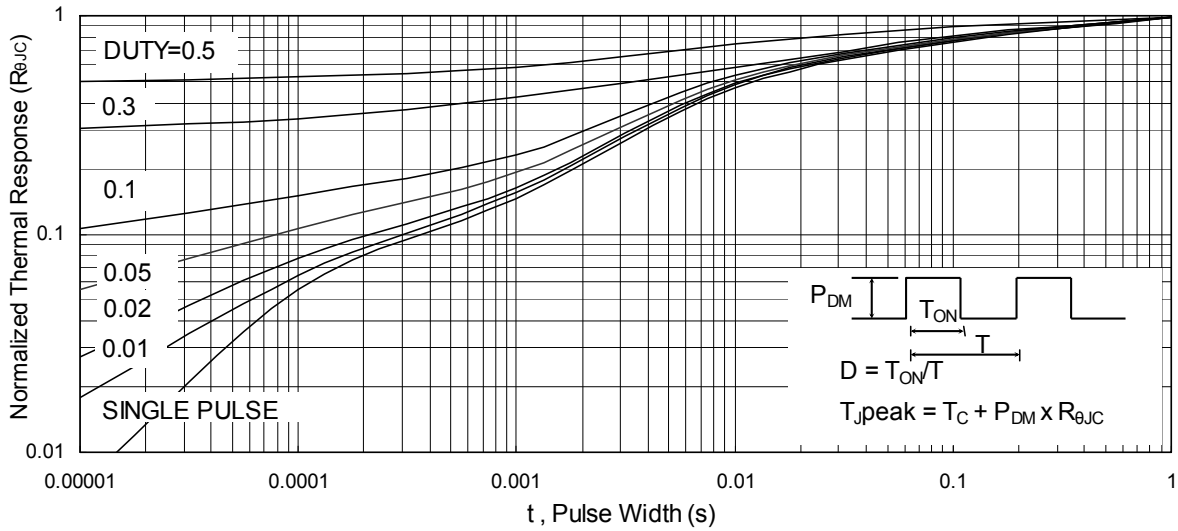

Fig.9 Normalized Maximum Transient Thermal Impedance

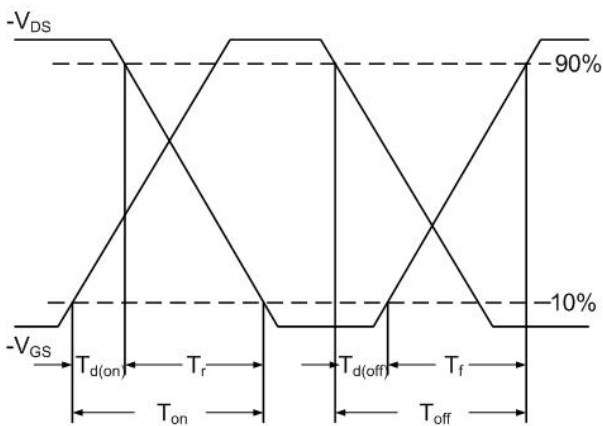

Fig.10 Switching Time Waveform

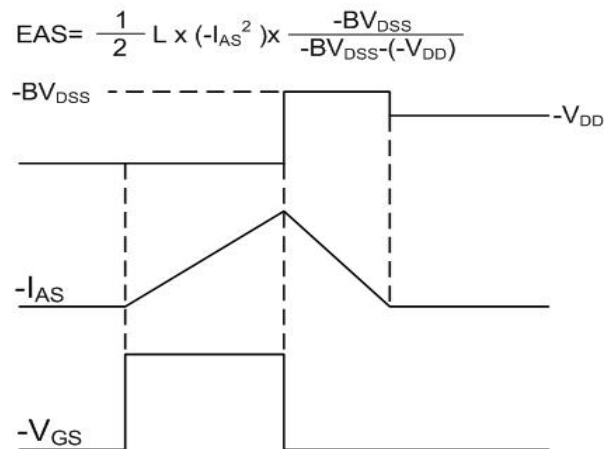

Fig.11 Unclamped Inductive Waveform