

N-Ch and P-Ch Fast Switching MOSFETs

General Description

The QM4306D is the highest performance trench N-ch and P-ch MOSFETs with extreme high cell density, which provide excellent R_{DS(on)} and gate charge for most of the synchronous buck converter applications.

The QM4306D meet the RoHS and Green Product requirement 100% EAS guaranteed with full function reliability approved.

Features

- Advanced high cell density Trench technology
- Super Low Gate Charge
- Excellent CdV/dt effect decline
- 100% EAS Guaranteed
- Green Device Available

Absolute Maximum Ratings

Symbol	Parameter	Rating		Units
		N-Ch	P-Ch	
V _{DS}	Drain-Source Voltage	40	-30	V
V _{GS}	Gate-Source Voltage	±20	±20	V
I _D @T _C =25°C	Continuous Drain Current, V _{GS} @ 10V ¹	65	-48	A
I _D @T _C =100°C	Continuous Drain Current, V _{GS} @ 10V ¹	50	-37	A
I _{DM}	Pulsed Drain Current ²	130	-100	A
EAS	Single Pulse Avalanche Energy ³	190	262	mJ
I _{AS}	Avalanche Current	47	-54	A
P _D @T _C =25°C	Total Power Dissipation ⁴	52.1	52.1	W
T _{STG}	Storage Temperature Range	-55 to 150	-55 to 150	°C
T _J	Operating Junction Temperature Range	-55 to 150	-55 to 150	°C

Thermal Data

Symbol	Parameter	Typ.	Max.	Unit
R _{θJA}	Thermal Resistance Junction-Ambient ¹	---	62	°C/W
R _{θJC}	Thermal Resistance Junction-Case ¹	---	2.4	°C/W

Product Summary



BVDSS	R _{DS(on)}	I _D
40V	8.5mΩ	65A
-40V	15mΩ	-48A

Applications

- High Frequency Point-of-Load Synchronous Buck Converter for MB/NB/UMPC/VGA
- Networking DC-DC Power System
- CCFL Back-light Inverter

TO252 Pin Configuration

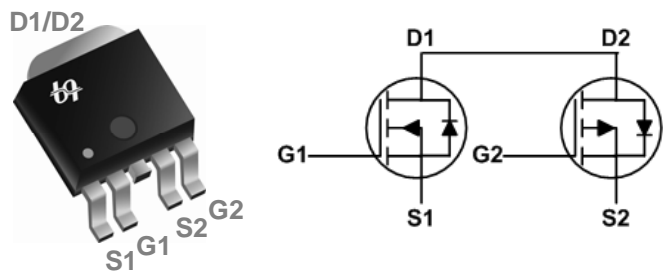

N-Ch and P-Ch Fast Switching MOSFETs
N-Channel Electrical Characteristics ($T_J=25^\circ\text{C}$, unless otherwise noted)

Symbol	Parameter	Conditions	Min.	Typ.	Max.	Unit
BV_{DSS}	Drain-Source Breakdown Voltage	$V_{GS}=0V, I_D=250\mu A$	40	---	---	V
$\Delta BV_{DSS}/\Delta T_J$	BVDSS Temperature Coefficient	Reference to 25°C , $I_D=1\text{mA}$	---	0.034	---	V/ $^\circ\text{C}$
$R_{DS(ON)}$	Static Drain-Source On-Resistance ²	$V_{GS}=10V, I_D=15A$	---	7	8.5	m Ω
		$V_{GS}=4.5V, I_D=12A$	---	8	10	
$V_{GS(th)}$	Gate Threshold Voltage	$V_{GS}=V_{DS}, I_D=250\mu A$	1.0	1.5	2.5	V
$\Delta V_{GS(th)}$	$V_{GS(th)}$ Temperature Coefficient		---	-5.84	---	mV/ $^\circ\text{C}$
I_{DSS}	Drain-Source Leakage Current	$V_{DS}=32V, V_{GS}=0V, T_J=25^\circ\text{C}$	---	---	1	μA
		$V_{DS}=32V, V_{GS}=0V, T_J=55^\circ\text{C}$	---	---	5	
I_{GSS}	Gate-Source Leakage Current	$V_{GS}=\pm 20V, V_{DS}=0V$	---	---	± 100	nA
g_{fs}	Forward Transconductance	$V_{DS}=5V, I_D=15A$	---	12	---	S
R_g	Gate Resistance	$V_{DS}=0V, V_{GS}=0V, f=1\text{MHz}$	---	1.4	2.8	Ω
Q_g	Total Gate Charge (4.5V)	$V_{DS}=20V, V_{GS}=4.5V, I_D=12A$	---	28	---	nC
Q_{gs}	Gate-Source Charge		---	7.85	---	
Q_{gd}	Gate-Drain Charge		---	12.5	---	
$T_{d(on)}$	Turn-On Delay Time	$V_{DD}=15V, V_{GS}=10V, R_G=3.3\Omega, I_D=1A$	---	20.2	---	ns
T_r	Rise Time		---	11.8	---	
$T_{d(off)}$	Turn-Off Delay Time		---	84.8	---	
T_f	Fall Time		---	8.6	---	
C_{iss}	Input Capacitance	$V_{DS}=15V, V_{GS}=0V, f=1\text{MHz}$	---	3354	---	pF
C_{oss}	Output Capacitance		---	275	---	
C_{riss}	Reverse Transfer Capacitance		---	204	---	

Guaranteed Avalanche Characteristics

Symbol	Parameter	Conditions	Min.	Typ.	Max.	Unit
EAS	Single Pulse Avalanche Energy ⁵	$V_{DD}=25V, L=0.1\text{mH}, I_{AS}=30A$	77.4	---	---	mJ

Diode Characteristics

Symbol	Parameter	Conditions	Min.	Typ.	Max.	Unit
I_S	Continuous Source Current ^{1,6}	$V_G=V_D=0V$, Force Current	---	---	65	A
I_{SM}	Pulsed Source Current ^{2,6}		---	---	130	A
V_{SD}	Diode Forward Voltage ²	$V_{GS}=0V, I_S=1A, T_J=25^\circ\text{C}$	---	---	1	V

Note :

- The data tested by surface mounted on a 1 inch² FR-4 board with 20Z copper.
- The data tested by pulsed, pulse width $\leq 300\mu\text{s}$, duty cycle $\leq 2\%$
- The EAS data shows Max. rating. The test condition is $V_{DD}=25V, V_{GS}=10V, L=0.1\text{mH}, I_{AS}=47A$
- The power dissipation is limited by 150°C junction temperature
- The Min. value is 100% EAS tested guarantee.
- The data is theoretically the same as I_D and I_{DM} , in real applications, should be limited by total power dissipation.

N-Ch and P-Ch Fast Switching MOSFETs

P-Channel Electrical Characteristics ($T_J=25\text{ }^\circ\text{C}$, unless otherwise noted)

Symbol	Parameter	Conditions	Min.	Typ.	Max.	Unit
BV_{DSS}	Drain-Source Breakdown Voltage	$V_{GS}=0V, I_D=-250\mu A$	-40	---	---	V
$\Delta BV_{DSS}/\Delta T_J$	BV_{DSS} Temperature Coefficient	Reference to 25°C , $I_D=-1\text{mA}$	---	-0.023	---	V/ $^\circ\text{C}$
$R_{DS(ON)}$	Static Drain-Source On-Resistance ²	$V_{GS}=-10V, I_D=-18A$	---	12	15	m Ω
		$V_{GS}=-4.5V, I_D=-12A$	---	17	21	
$V_{GS(th)}$	Gate Threshold Voltage	$V_{GS}=V_{DS}, I_D=-250\mu A$	-1.0	-1.6	-2.5	V
$\Delta V_{GS(th)}$	$V_{GS(th)}$ Temperature Coefficient		---	4.74	---	mV/ $^\circ\text{C}$
I_{DSS}	Drain-Source Leakage Current	$V_{DS}=-32V, V_{GS}=0V, T_J=25^\circ\text{C}$	---	---	1	μA
		$V_{DS}=-32V, V_{GS}=0V, T_J=55^\circ\text{C}$	---	---	5	
I_{GSS}	Gate-Source Leakage Current	$V_{GS}=\pm 20V, V_{DS}=0V$	---	---	± 100	nA
g_{fs}	Forward Transconductance	$V_{DS}=-10V, I_D=-18A$	---	11	---	S
R_g	Gate Resistance	$V_{DS}=0V, V_{GS}=0V, f=1\text{MHz}$	---	7	14	Ω
Q_g	Total Gate Charge (-4.5V)	$V_{DS}=-20V, V_{GS}=-4.5V, I_D=-12A$	---	27.9	---	nC
Q_{gs}	Gate-Source Charge		---	7.7	---	
Q_{gd}	Gate-Drain Charge		---	7.5	---	
$T_{d(on)}$	Turn-On Delay Time	$V_{DD}=-15V, V_{GS}=-10V, R_G=3.3\Omega, I_D=-1A$	---	40	---	ns
T_r	Rise Time		---	35.2	---	
$T_{d(off)}$	Turn-Off Delay Time		---	100	---	
T_f	Fall Time		---	9.6	---	
C_{iss}	Input Capacitance	$V_{DS}=-15V, V_{GS}=0V, f=1\text{MHz}$	---	3497	---	pF
C_{oss}	Output Capacitance		---	323	---	
C_{riss}	Reverse Transfer Capacitance		---	222	---	

Guaranteed Avalanche Characteristics

Symbol	Parameter	Conditions	Min.	Typ.	Max.	Unit
EAS	Single Pulse Avalanche Energy ⁵	$V_{DD}=-25V, L=0.1\text{mH}, I_{AS}=-30A$	81	---	---	mJ

Diode Characteristics

Symbol	Parameter	Conditions	Min.	Typ.	Max.	Unit
I_S	Continuous Source Current ^{1,6}	$V_G=V_D=0V$, Force Current	---	---	-48	A
I_{SM}	Pulsed Source Current ^{2,6}		---	---	-100	A
V_{SD}	Diode Forward Voltage ²	$V_{GS}=0V, I_S=-1A, T_J=25^\circ\text{C}$	---	---	-1	V

Note :

- 1.The data tested by surface mounted on a 1 inch²FR-4 board with 20Z copper.
- 2.The data tested by pulsed , pulse width $\leq 300\mu\text{s}$, duty cycle $\leq 2\%$
- 3.The EAS data shows Max. rating . The test condition is $V_{DD}=-25V, V_{GS}=-10V, L=0.1\text{mH}, I_{AS}=-54A$
- 4.The power dissipation is limited by 150°C junction temperature
- 5.The Min. value is 100% EAS tested guarantee.
- 6.The data is theoretically the same as I_D and I_{DM} , in real applications , should be limited by total power dissipation.

N-Channel Typical Characteristics

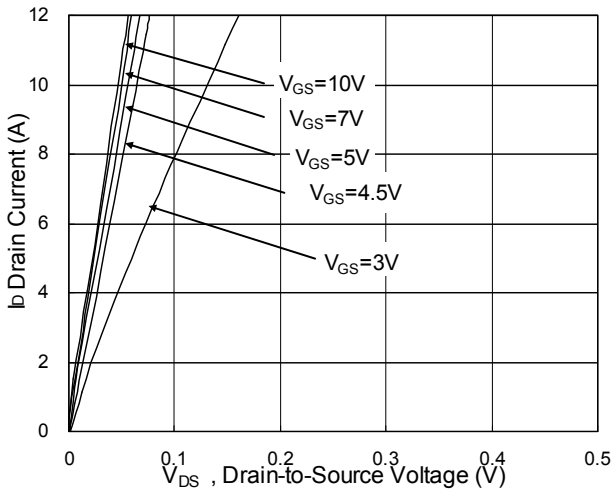

Fig.1 Typical Output Characteristics

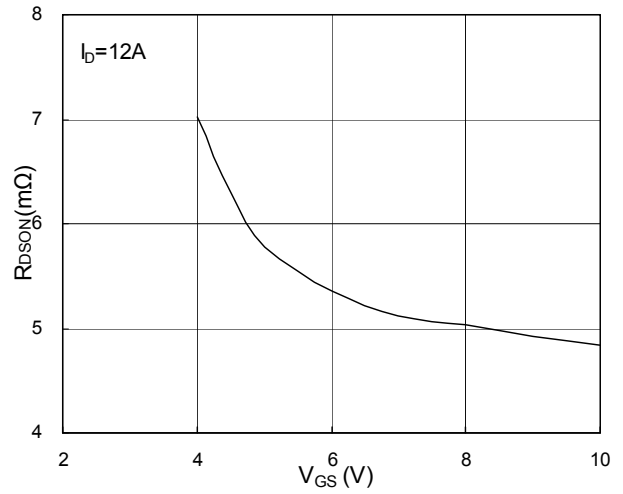

Fig.2 On-Resistance vs. G-S Voltage

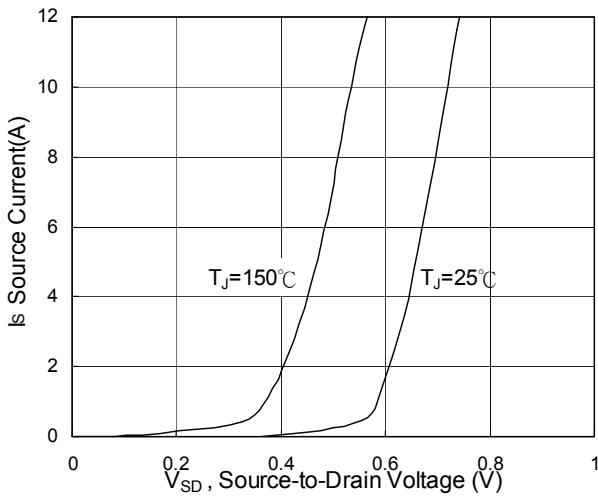

Fig.3 Forward Characteristics of Reverse

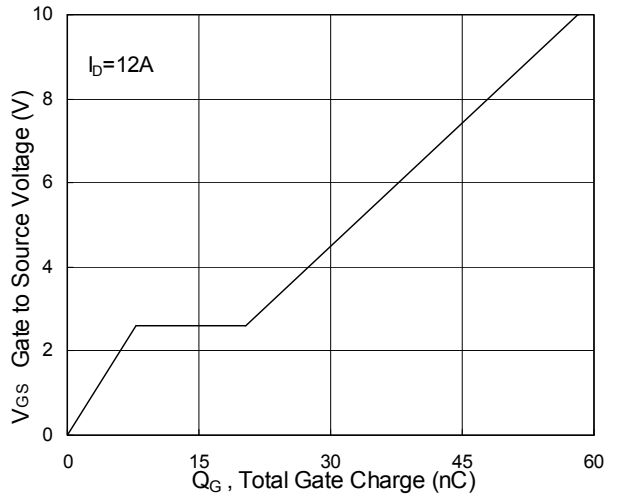

Fig.4 Gate-Charge Characteristics

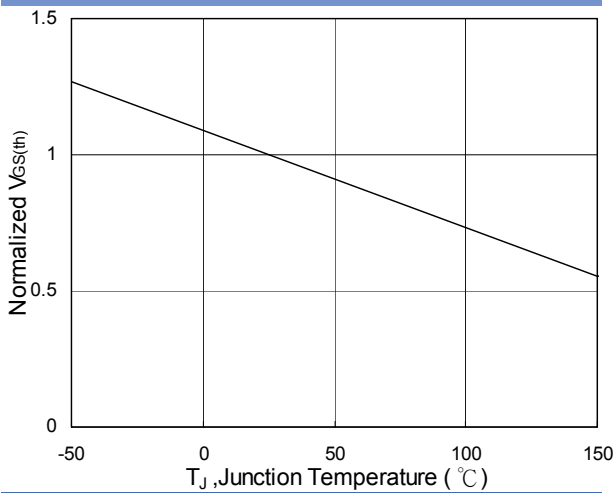

Fig.5 Normalized V_{GS(th)} vs. T_J

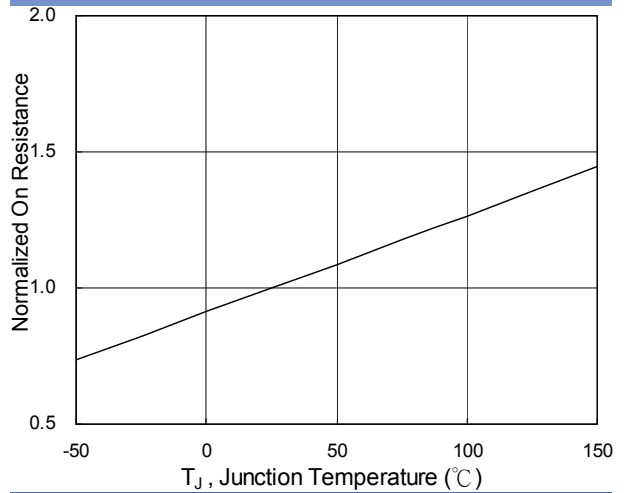

Fig.6 Normalized R_{DS(on)} vs. T_J

N-Ch and P-Ch Fast Switching MOSFETs

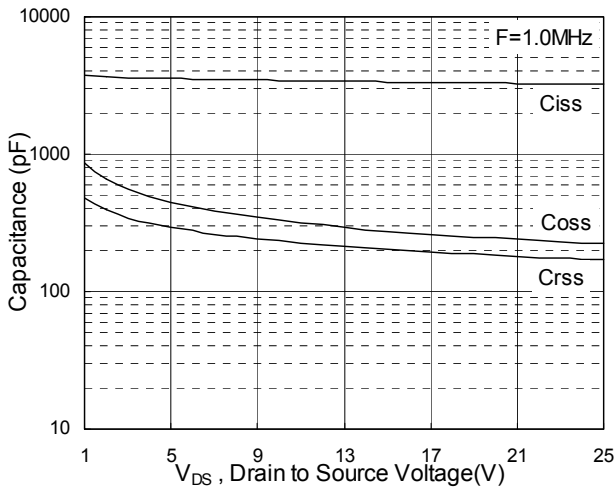

Fig.7 Capacitance

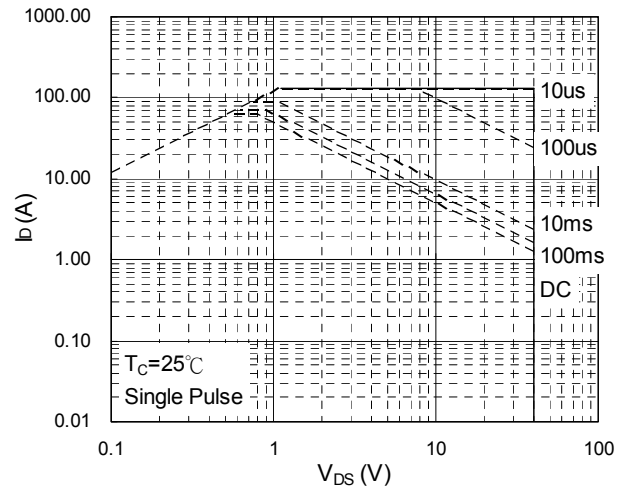

Fig.8 Safe Operating Area

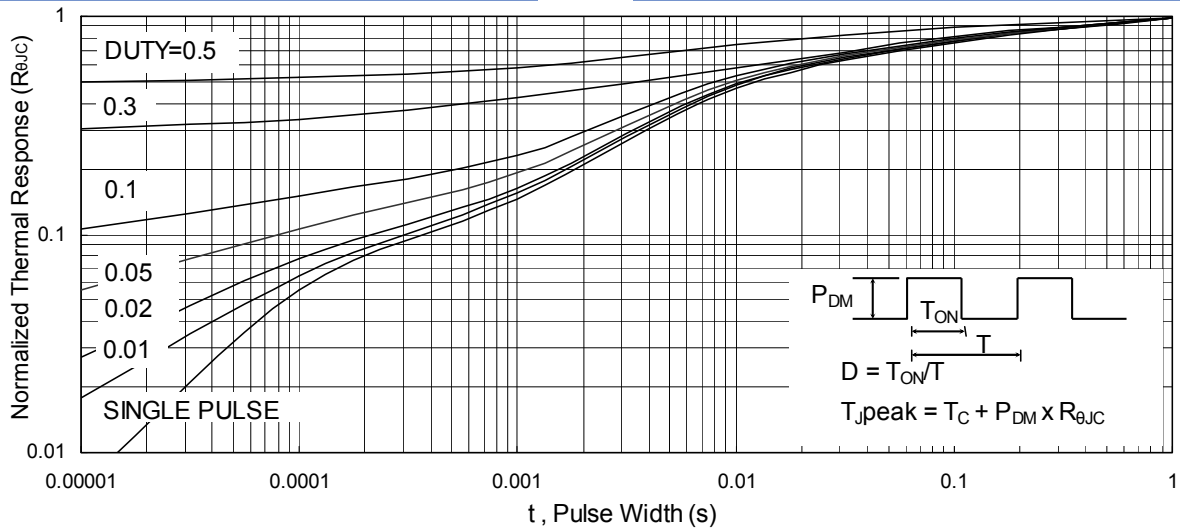

Fig.9 Normalized Maximum Transient Thermal Impedance

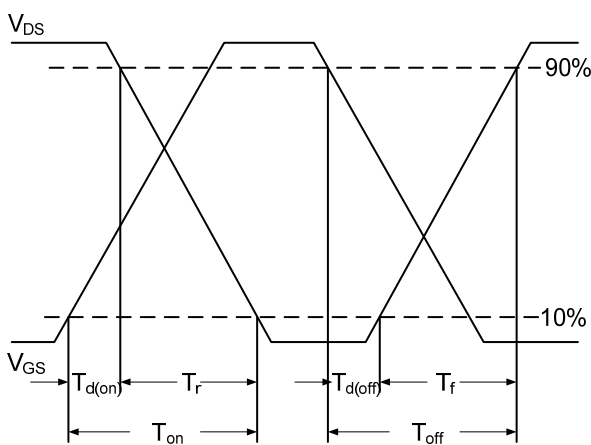

Fig.10 Switching Time Waveform

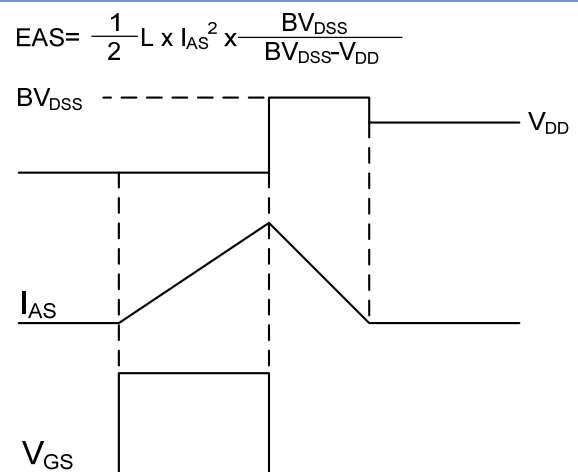

Fig.11 Unclamped Inductive Switching Wave

N-Ch and P-Ch Fast Switching MOSFETs

P-Channel Typical Characteristics

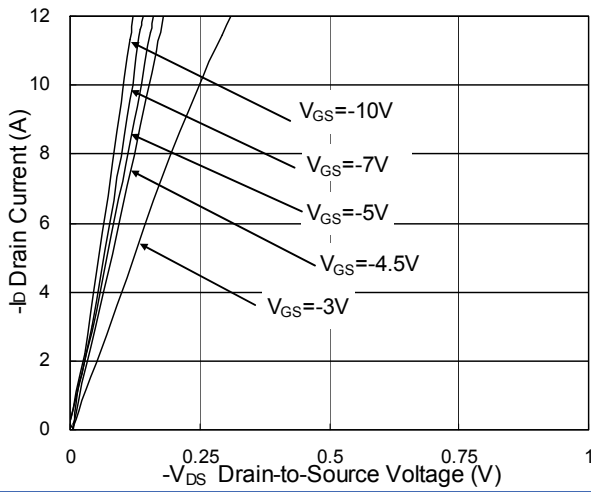

Fig.1 Typical Output Characteristics

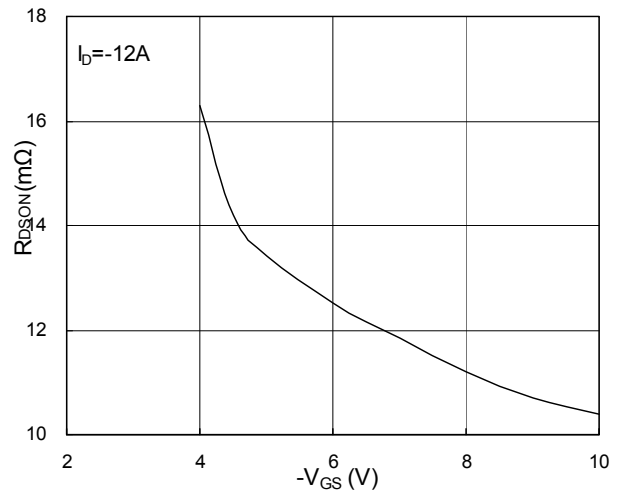

Fig.2 On-Resistance v.s Gate-Source

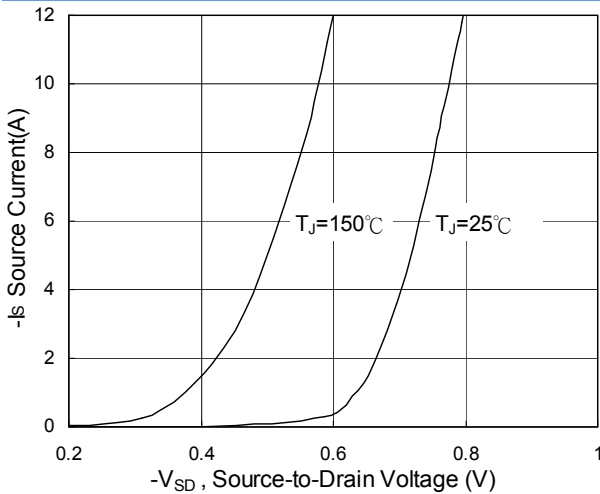

Fig.3 Forward characteristics of reverse

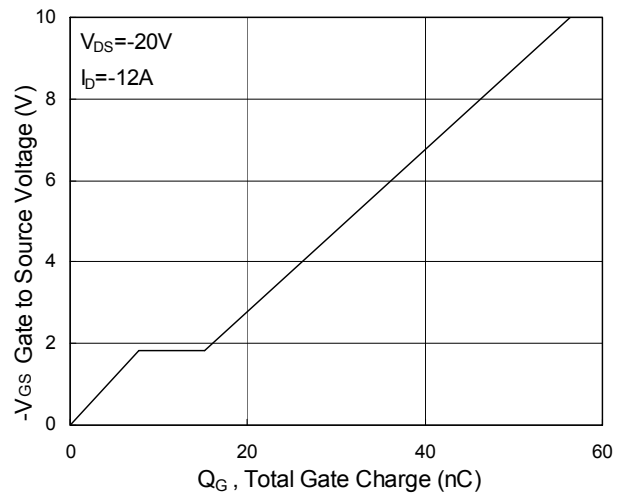

Fig.4 Gate-charge characteristics

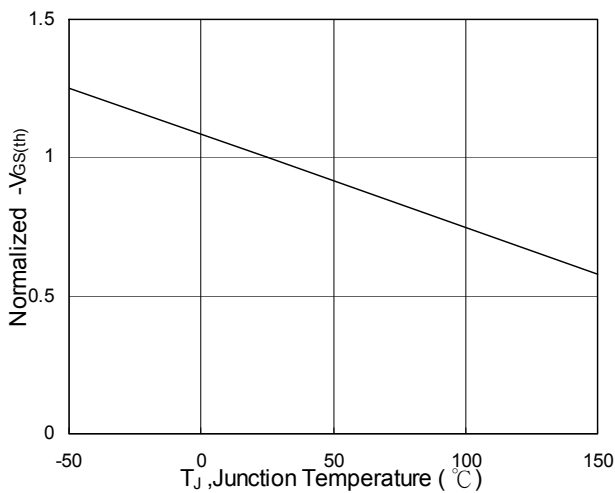

Fig.5 Normalized $V_{GS(th)}$ v.s T_J

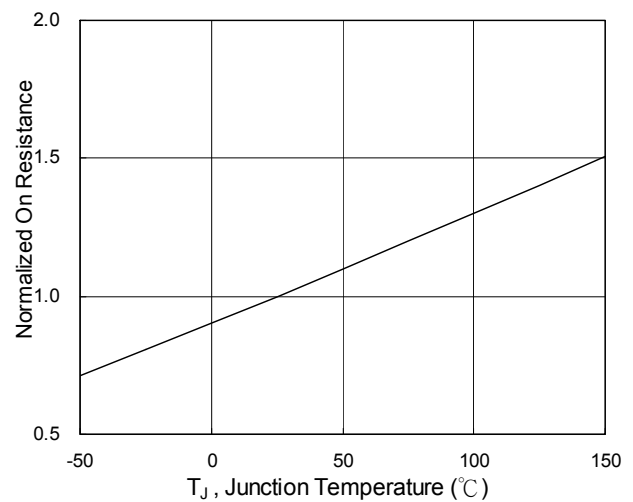

Fig.6 Normalized $R_{DS(on)}$ v.s T_J

N-Ch and P-Ch Fast Switching MOSFETs

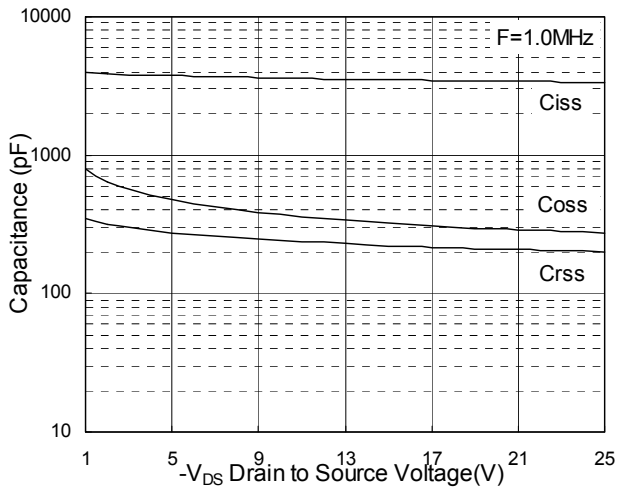

Fig.7 Capacitance

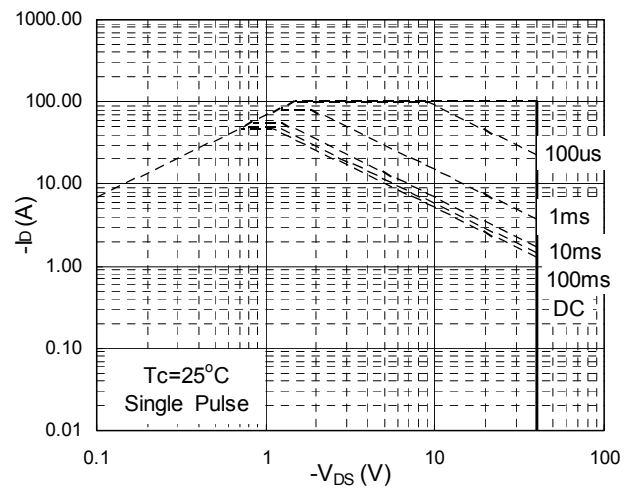

Fig.8 Safe operating area

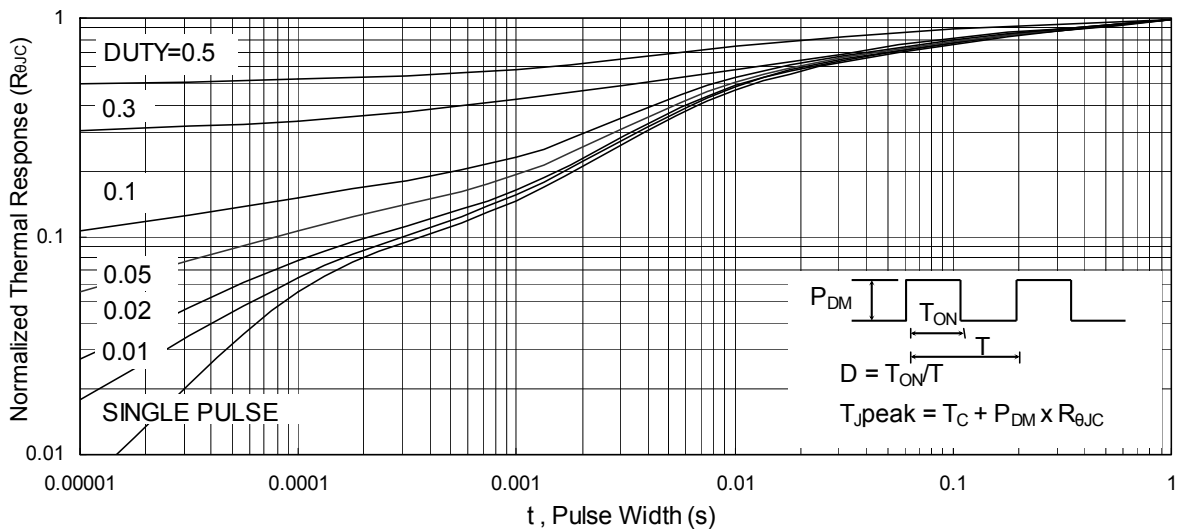

Fig.9 Normalized Maximum Transient Thermal Impedance

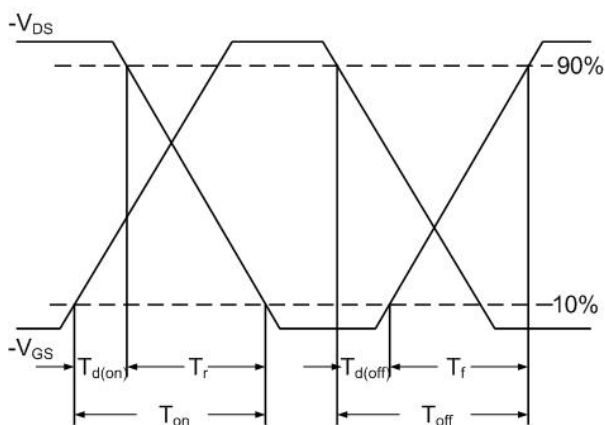

Fig.10 Switching time waveform

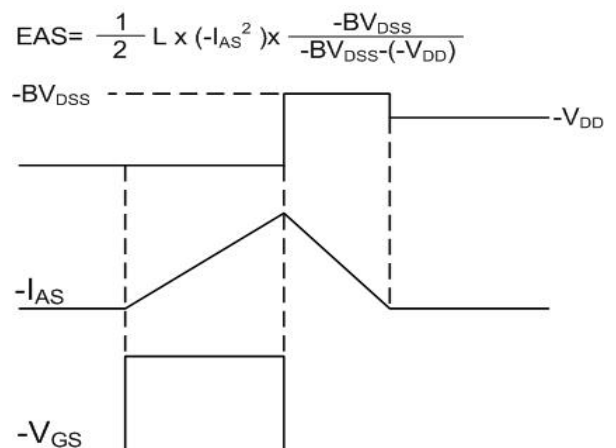

Fig.11 Unclamped inductive waveform