

General Description

The QM3004U is the highest performance trench N-ch MOSFETs with extreme high cell density, which provide excellent RDSON and gate charge for most of the synchronous buck converter applications.

The QM3004U meet the RoHS and Green Product requirement, 100% EAS guaranteed with full function reliability approved.

Features

- Advanced high cell density Trench technology
- Super Low Gate Charge
- Excellent CdV/dt effect decline
- 100% EAS Guaranteed
- Green Device Available

Absolute Maximum Ratings

| Symbol | Parameter | Rating | Units |
|-----------------------|--|------------|------------|
| V_{DS} | Drain-Source Voltage | 30 | V |
| V_{GS} | Gate-Source Voltage | ± 20 | V |
| $I_D@T_C=25^\circ C$ | Continuous Drain Current, $V_{GS} @ 10V^1$ | 55 | A |
| $I_D@T_C=100^\circ C$ | Continuous Drain Current, $V_{GS} @ 10V^1$ | 40 | A |
| $I_D@T_A=25^\circ C$ | Continuous Drain Current, $V_{GS} @ 10V^1$ | 13.6 | A |
| $I_D@T_A=70^\circ C$ | Continuous Drain Current, $V_{GS} @ 10V^1$ | 11.4 | A |
| I_{DM} | Pulsed Drain Current ² | 110 | A |
| EAS | Single Pulse Avalanche Energy ³ | 130 | mJ |
| I_{AS} | Avalanche Current | 34 | A |
| $P_D@T_C=25^\circ C$ | Total Power Dissipation ⁴ | 41 | W |
| $P_D@T_A=25^\circ C$ | Total Power Dissipation ⁴ | 2.42 | W |
| T_{STG} | Storage Temperature Range | -55 to 175 | $^\circ C$ |
| T_J | Operating Junction Temperature Range | -55 to 175 | $^\circ C$ |

Thermal Data

| Symbol | Parameter | Typ. | Max. | Unit |
|-----------------|---|------|------|--------------|
| $R_{\theta JA}$ | Thermal Resistance Junction-ambient (Steady State) ¹ | --- | 62 | $^\circ C/W$ |
| $R_{\theta JC}$ | Thermal Resistance Junction-Case ¹ | --- | 3.6 | $^\circ C/W$ |

Product Summary



| BVDSS | RDSON | ID |
|-------|---------------|-----|
| 30V | 8.5m Ω | 55A |

Applications

- High Frequency Point-of-Load Synchronous Buck Converter for MB/NB/UMPC/VGA
- Networking DC-DC Power System
- Load Switch

TO251 Pin Configuration

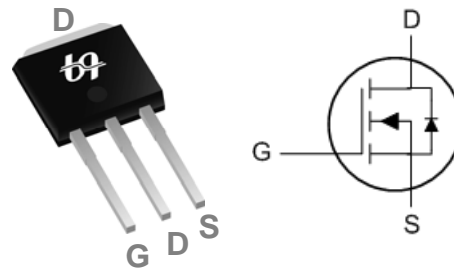

Electrical Characteristics ($T_J=25^\circ\text{C}$, unless otherwise noted)

| Symbol | Parameter | Conditions | Min. | Typ. | Max. | Unit |
|------------------------------|--|--|------|-------|-----------|----------------------|
| BV_{DSS} | Drain-Source Breakdown Voltage | $V_{GS}=0V, I_D=250\mu A$ | 30 | --- | --- | V |
| $\Delta BV_{DSS}/\Delta T_J$ | BVDSS Temperature Coefficient | Reference to 25°C , $I_D=1\text{mA}$ | --- | 0.027 | --- | V/ $^\circ\text{C}$ |
| $R_{DS(ON)}$ | Static Drain-Source On-Resistance ² | $V_{GS}=10V, I_D=30A$ | --- | 7.5 | 8.5 | m Ω |
| | | $V_{GS}=4.5V, I_D=15A$ | --- | 11 | 14 | |
| $V_{GS(th)}$ | Gate Threshold Voltage | $V_{GS}=V_{DS}, I_D=250\mu A$ | 1.2 | 1.5 | 2.5 | V |
| $\Delta V_{GS(th)}$ | $V_{GS(th)}$ Temperature Coefficient | | --- | -5.8 | --- | mV/ $^\circ\text{C}$ |
| I_{DSS} | Drain-Source Leakage Current | $V_{DS}=24V, V_{GS}=0V, T_J=25^\circ\text{C}$ | --- | --- | 1 | μA |
| | | $V_{DS}=24V, V_{GS}=0V, T_J=55^\circ\text{C}$ | --- | --- | 5 | |
| I_{GSS} | Gate-Source Leakage Current | $V_{GS}=\pm 20V, V_{DS}=0V$ | --- | --- | ± 100 | nA |
| g_{fs} | Forward Transconductance | $V_{DS}=5V, I_D=30A$ | --- | 38 | --- | S |
| R_g | Gate Resistance | $V_{DS}=0V, V_{GS}=0V, f=1\text{MHz}$ | --- | 2.2 | 3.5 | Ω |
| Q_g | Total Gate Charge (4.5V) | $V_{DS}=15V, V_{GS}=4.5V, I_D=15A$ | --- | 12.6 | 17.6 | nC |
| Q_{gs} | Gate-Source Charge | | --- | 4.2 | 5.9 | |
| Q_{gd} | Gate-Drain Charge | | --- | 5.1 | 7.1 | |
| $T_{d(on)}$ | Turn-On Delay Time | $V_{DD}=15V, V_{GS}=10V, R_G=3.3\Omega, I_D=15A$ | --- | 4.6 | 9.2 | ns |
| T_r | Rise Time | | --- | 12.2 | 22 | |
| $T_{d(off)}$ | Turn-Off Delay Time | | --- | 26.6 | 53 | |
| T_f | Fall Time | | --- | 8 | 16 | |
| C_{iss} | Input Capacitance | $V_{DS}=15V, V_{GS}=0V, f=1\text{MHz}$ | --- | 1317 | 1843 | pF |
| C_{oss} | Output Capacitance | | --- | 163 | 228 | |
| C_{riss} | Reverse Transfer Capacitance | | --- | 131 | 183 | |

Guaranteed Avalanche Characteristics

| Symbol | Parameter | Conditions | Min. | Typ. | Max. | Unit |
|--------|--|--|------|------|------|------|
| EAS | Single Pulse Avalanche Energy ⁵ | $V_{DD}=25V, L=0.1\text{mH}, I_{AS}=20A$ | 45 | --- | --- | mJ |

Diode Characteristics

| Symbol | Parameter | Conditions | Min. | Typ. | Max. | Unit |
|----------|--|---|------|------|------|------|
| I_S | Continuous Source Current ^{1,6} | $V_G=V_D=0V$, Force Current | --- | --- | 55 | A |
| I_{SM} | Pulsed Source Current ^{2,6} | | --- | --- | 110 | A |
| V_{SD} | Diode Forward Voltage ² | $V_{GS}=0V, I_S=1A, T_J=25^\circ\text{C}$ | --- | --- | 1.2 | V |
| t_{rr} | Reverse Recovery Time | $I_F=30A, dI/dt=100A/\mu s, T_J=25^\circ\text{C}$ | --- | 9.2 | --- | nS |
| Q_{rr} | Reverse Recovery Charge | | --- | 2 | --- | nC |

Note :

- The data tested by surface mounted on a 1 inch² FR-4 board with 20Z copper.
- The data tested by pulsed, pulse width $\leq 300\mu s$, duty cycle $\leq 2\%$
- The EAS data shows Max. rating. The test condition is $V_{DD}=25V, V_{GS}=10V, L=0.1\text{mH}, I_{AS}=34A$
- The power dissipation is limited by 175°C junction temperature
- The Min. value is 100% EAS tested guarantee.
- The data is theoretically the same as I_D and I_{DM} , in real applications, should be limited by total power dissipation.

N-Ch 30V Fast Switching MOSFETs

Typical Characteristics

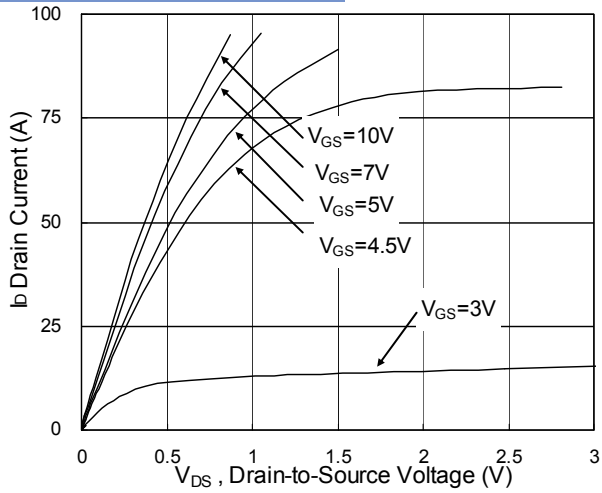

Fig.1 Typical Output Characteristics

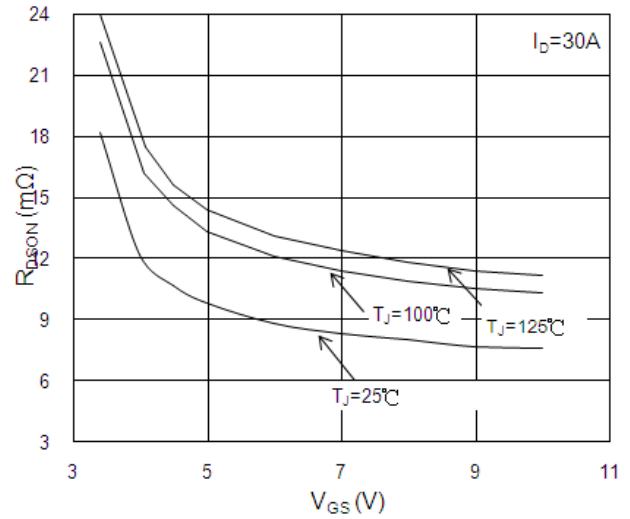

Fig.2 On-Resistance vs. G-S Voltage

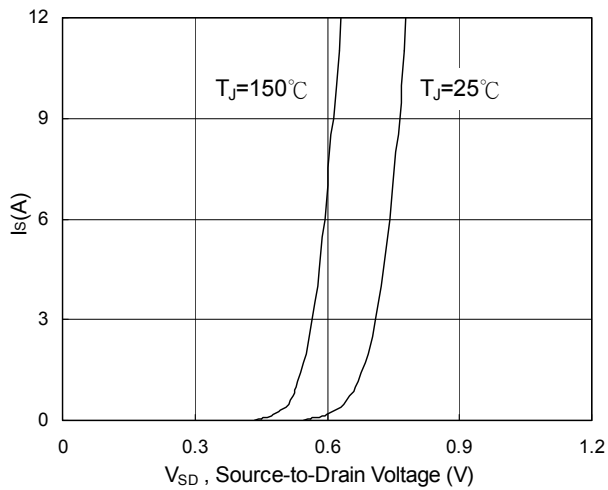

Fig.3 Forward Characteristics of Reverse

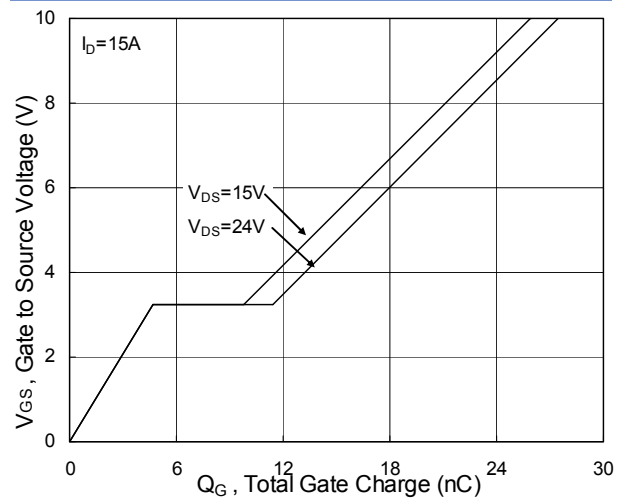

Fig.4 Gate-Charge Characteristics

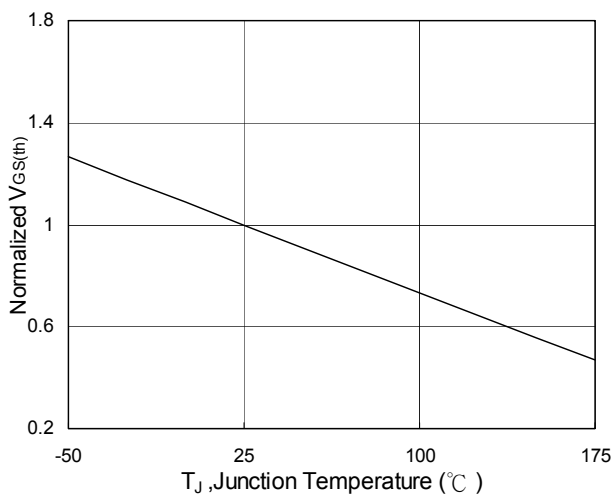

Fig.5 Normalized $V_{GS(th)}$ vs. T_J

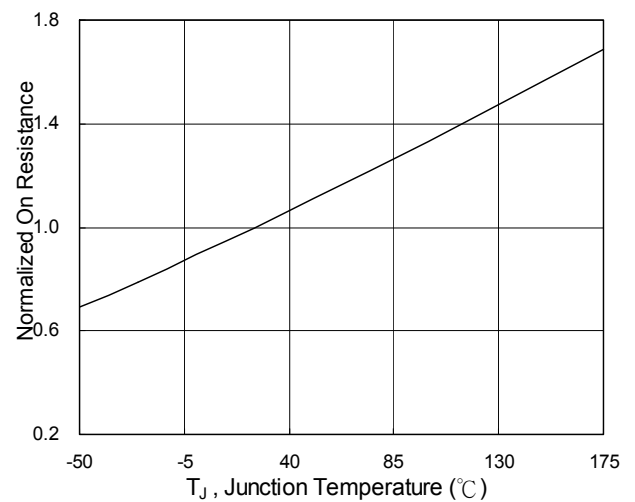

Fig.6 Normalized $R_{DS(on)}$ vs. T_J

N-Ch 30V Fast Switching MOSFETs

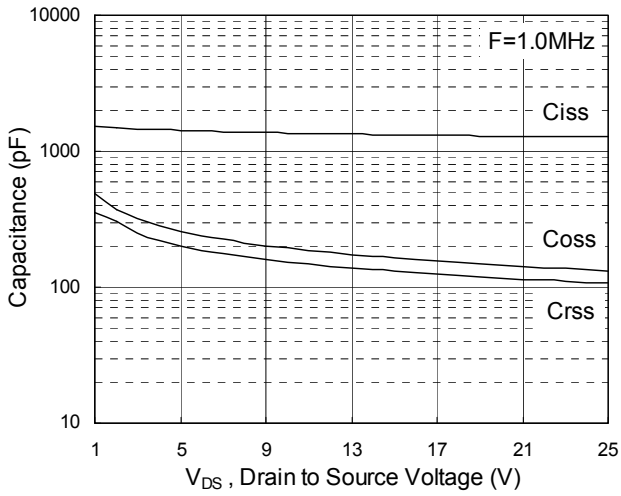

Fig.7 Capacitance

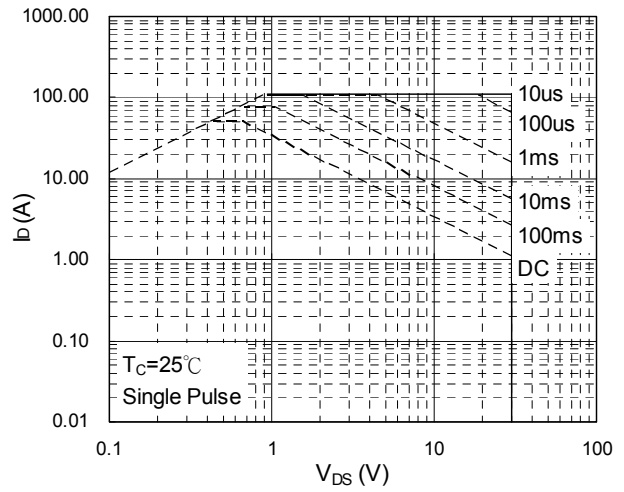

Fig.8 Safe Operating Area

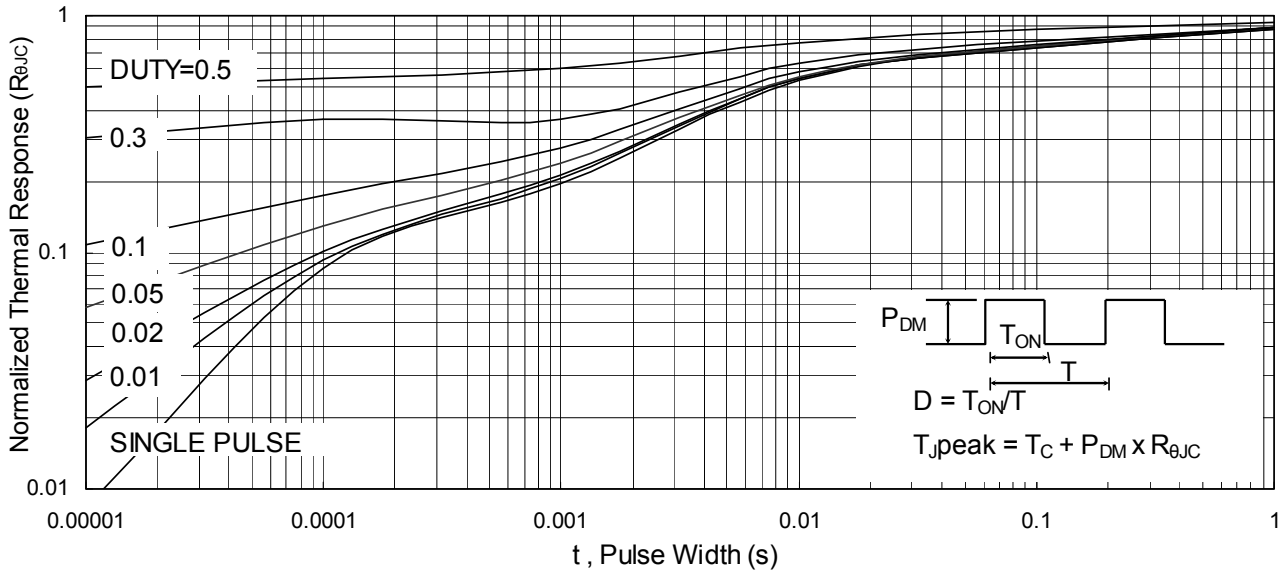

Fig.9 Normalized Maximum Transient Thermal Impedance

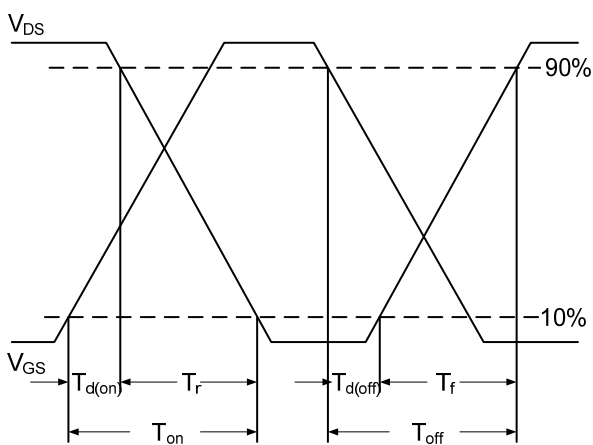

Fig.10 Switching Time Waveform

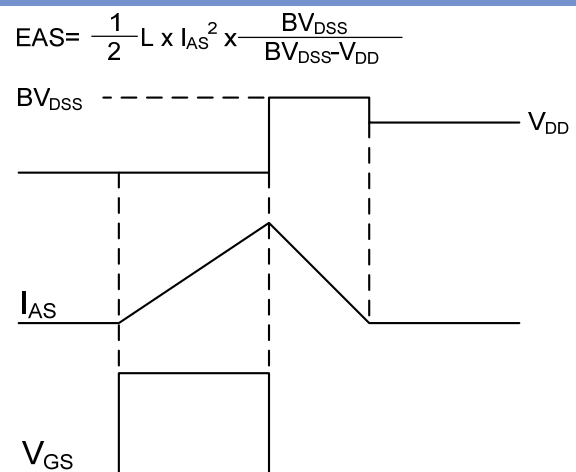

Fig.11 Unclamped Inductive Switching Waveform