



DESCRIPTION

The AM2300 is the N-Channel logic enhancement mode power field effect transistor is produced using high cell density. Advanced trench technology to provide excellent $R_{DS(ON)}$.

This high density process is especially tailored to minimize on-state resistance. These devices are particularly suited for low voltage application, and low in-line power loss are needed in a very small outline surface mount package.

AM2300 is available in SOT-23 packages.

ORDER INFORMATION

Package Type	Part Number	
SOT-23	E3	AM2300E3R
		AM2300E3VR
Note	V: Green Package R : Tape & Reel	
AiT provides all Pb free products Suffix " V " means Green Package		

FEATURES

- 20V/4.0A, $R_{DS(ON)} = 26m\Omega$ (typ.)@ $V_{GS} = 4.5V$
- 20V/3.0A, $R_{DS(ON)} = 31m\Omega$ (typ.)@ $V_{GS} = 2.5V$
- 20V/2.0A, $R_{DS(ON)} = 44m\Omega$ (typ.)@ $V_{GS} = 1.8V$
- Super high density cell design for extremely low $R_{DS(ON)}$
- Exceptional on-resistance and Maximum DC current capability
- Available in SOT-23 Package

APPLICATION

- Power Management in Note book
- Portable Equipment
- Battery Powered System
- DC/DC Converter

PIN CONFIGURATION

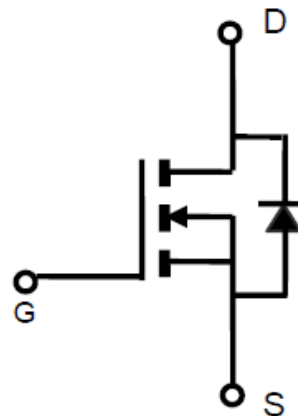



PIN DESCRIPTION

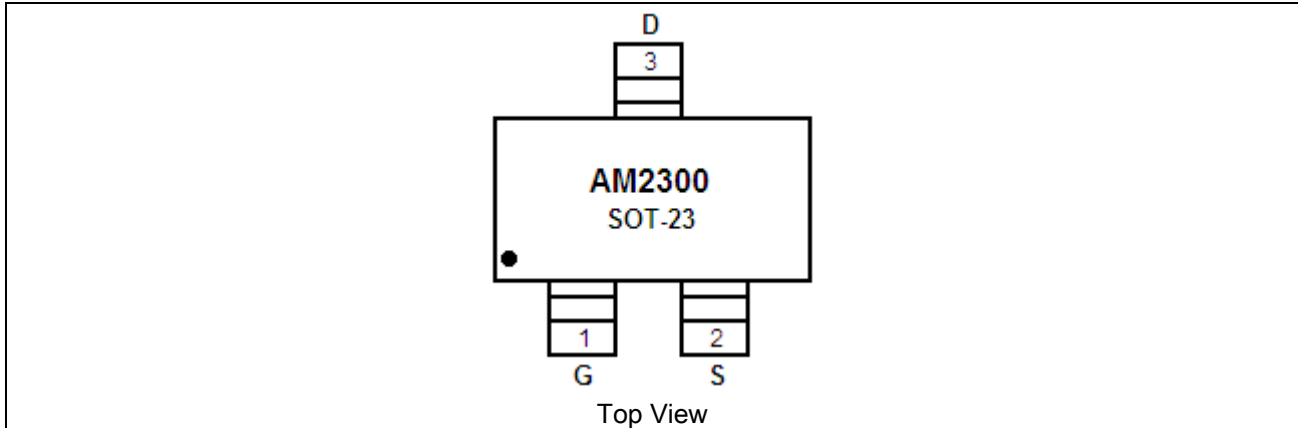

Pin #	Symbol	Function
1	G	Gate
2	S	Source
3	D	Drain



ABSOLUTE MAXIMUM RATINGS

$T_A = 25^\circ\text{C}$ Unless otherwise specified

V_{DSS} , Drain-Source Voltage	20V
V_{GSS} , Gate-Source Voltage	$\pm 12\text{V}$
I_D , Continuous Drain Current ($T_J=150^\circ\text{C}$)	$V_{GS}=10\text{V}$ 4A
I_{DM} , Pulsed Drain Current	20A
I_S , Continuous Source Current (Diode Conduction)	1A
P_D , Power Dissipation	
$T_A=25^\circ\text{C}$	1.25W
$T_A=70^\circ\text{C}$	0.8W
T_J , Operation Junction Temperature	150°C
T_{STG} , Storage Temperature Range	-55/150°C

Stresses above may cause permanent damage to the device. These are stress ratings only, and functional operation of the device at these or any other conditions beyond those indicated in the Electrical Characteristics is not implied. Exposure to absolute maximum rating conditions for extended periods may affect device reliability.

THERMAL INFORMATION

Symbol	Max	Unit
θ_{JA}	120	°C/W



ELECTRICAL CHARACTERISTICS

T_A = 25°C Unless otherwise specified

Parameter	Symbol	Conditions	MIN	TYP	MAX	Unit
Static Parameters						
Drain-Source Breakdown Voltage	V _{(BR)DSS}	V _{GS} =0V, I _D =250μA	20	-	-	V
Gate Threshold Voltage	V _{GS(th)}	V _{DS} =V _{GS} , I _D =250μA	0.4	-	1.0	V
Gate Leakage Current	I _{GSS}	V _{DS} =0V, V _{GS} =±12V	-	-	±100	nA
Zero Gate Voltage Drain Current	I _{DSS}	V _{DS} =20V, V _{GS} =0V	-	-	1	μA
		V _{DS} =20V, V _{GS} =0V T _J =55°C	-	-	10	
On-State Drain Current	I _{D(ON)}	V _{DS} ≥5V, V _{GS} =4.5V	5	-	-	A
Drain-source On-Resistance	R _{DS(ON)}	V _{GS} =4.5V, I _D =4.0A	-	26	30	mΩ
		V _{GS} =2.5V, I _D =3.0A	-	31	38	
		V _{GS} =1.8V, I _D =2.0A	-	44	55	
Source-Drain Diode						
Diode Forward Voltage	V _{SD}	I _S =1A, V _{GS} =0V	-	0.7	1.2	V
Dynamic Parameters						
Total Gate Charge	Q _g	V _{DS} =10V	-	6.5	-	nC
Gate-Source Charge	Q _{gs}	V _{GS} =4.5V	-	0.7	-	
Gate-Drain Charge	Q _{gd}	I _D =5.5A	-	2.8	-	
Input Capacitance	C _{ISS}	V _{DS} =10V	-	440	-	pF
Output Capacitance	C _{OSS}	V _{GS} =0V	-	110	-	
Reverse Transfer Capacitance	C _{RSS}	f=1MHz	-	90	-	
Turn-On Time	t _{d(on)}	V _{DD} =10V	-	6	10	nS
	t _r	R _L =10Ω	-	15	28	
Turn-Off Time	t _{d(off)}	I _D =1.0A	-	26	48	
	t _f	V _{GEN} =4.5V R _G =6Ω	-	16	28	

Note : 1. Pulse test: pulse width ≤ 300us, duty cycle ≤ 2%

2. Static parameters are based on package level with recommended wire-bonding



TYPICAL PERFORMANCE CHARACTERISTICS

1. Output Characteristics

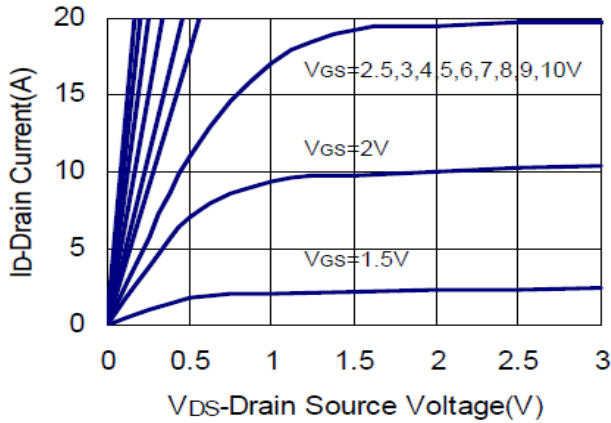

2. Drain-Source On Resistance

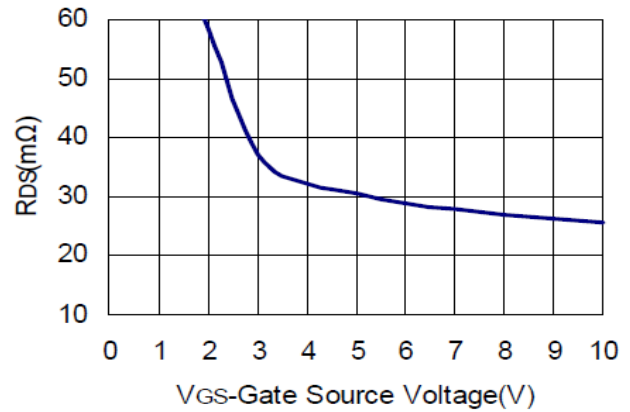

3. Drain Source On Resistance

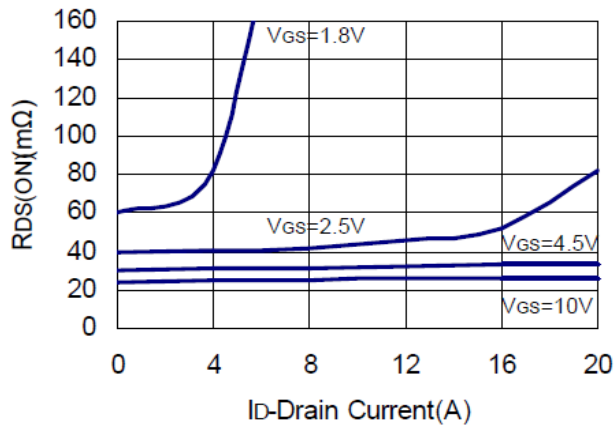

4. Gate Threshold Voltage

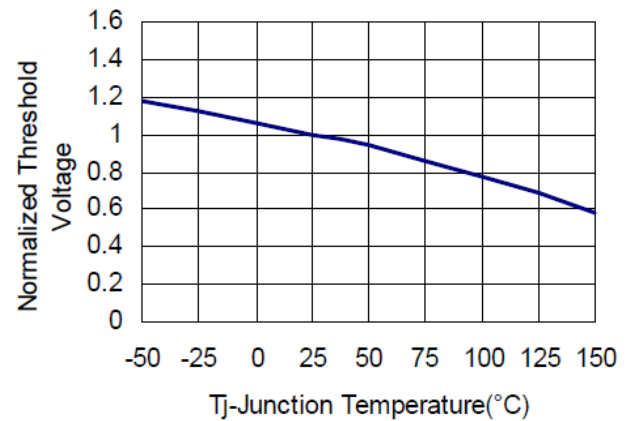

5. Gate Charge

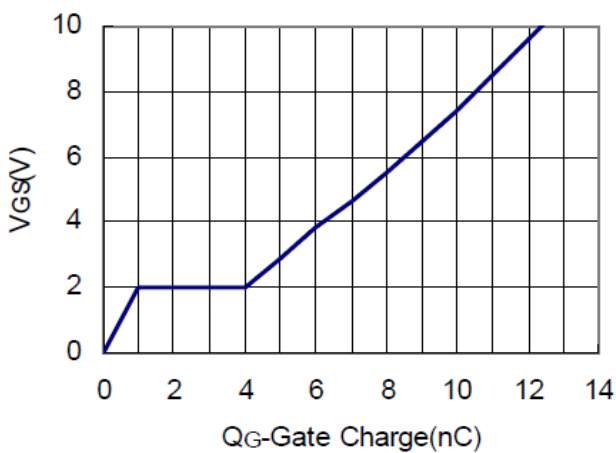

6. Drain Source On Resistance

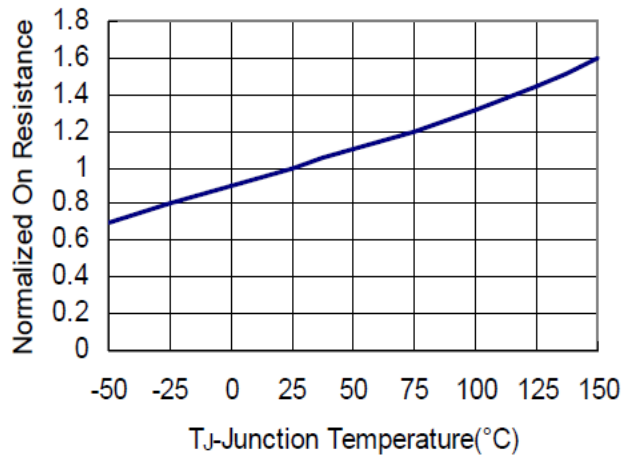



7. Source Drain Diode Forward

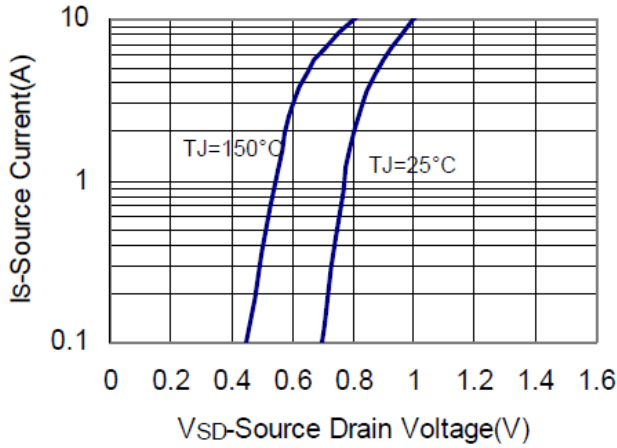

8. Capacitance

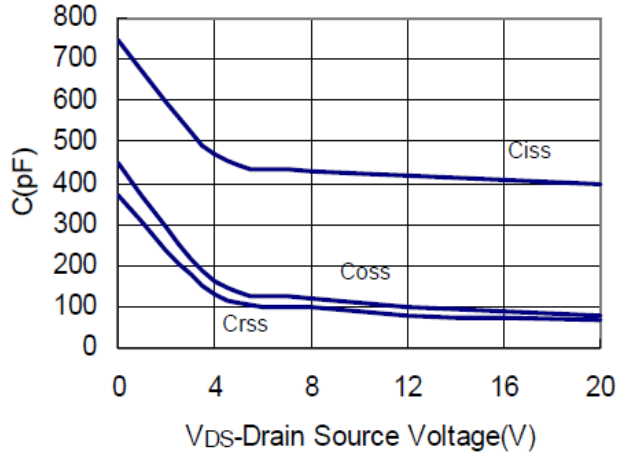

9. Power Dissipation

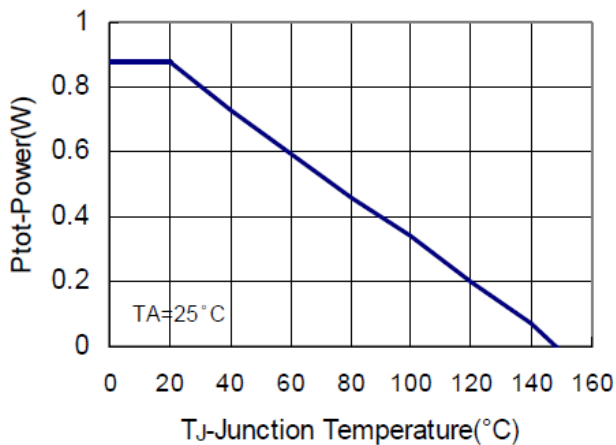

10. Drain Current

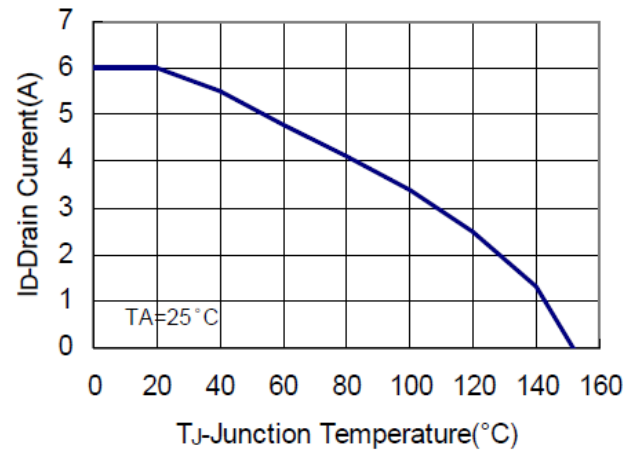

11. Thermal Transient Impedance

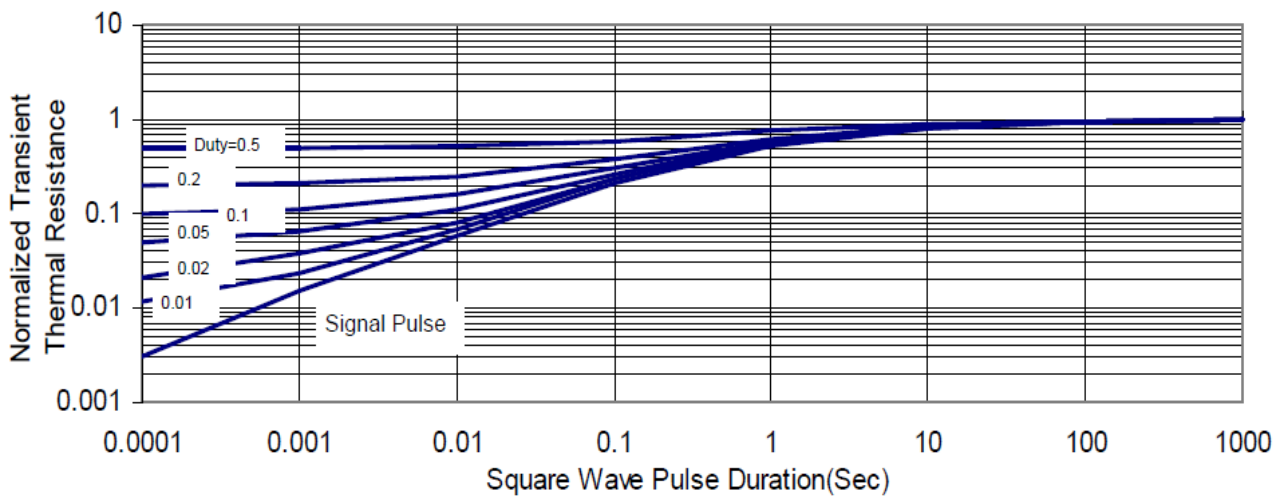



PACKAGE INFORMATION

Dimension in SOT-23 Package (Unit: mm)

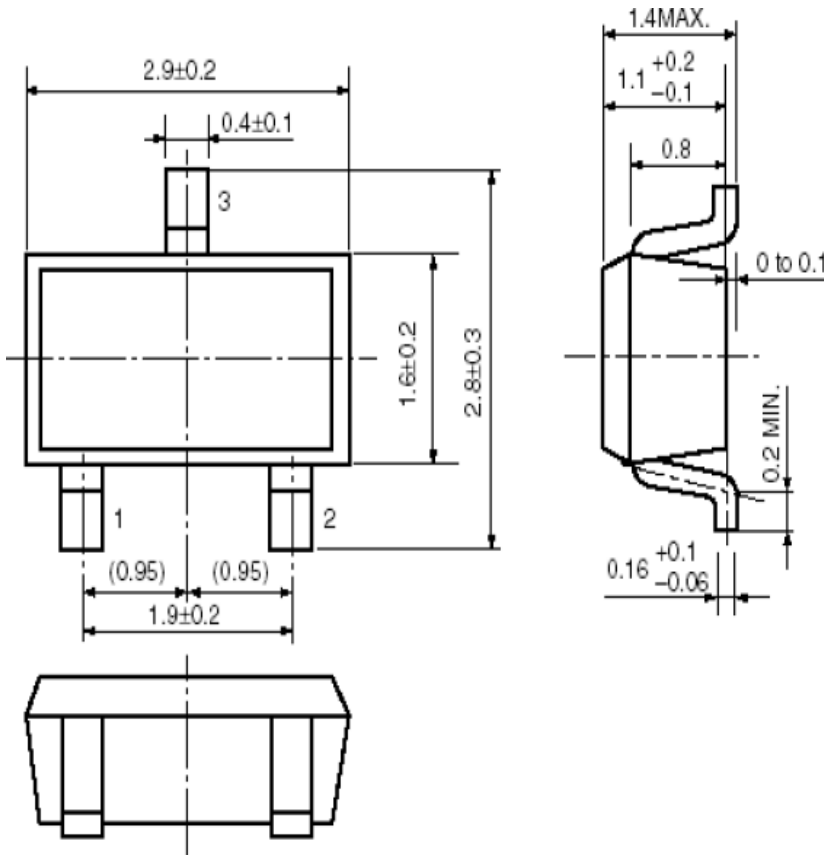

Symbol	Min	Max
A	2.800	3.040
B	2.100	2.640
C	1.200	1.400
D	0.890	1.030
E	1.780	2.050
F	0.450	0.600
G	0.013	0.100
H	0.890	1.120
J	0.085	0.180
K	0.370	0.510

Tape Dimension

Tape & Reel Dimension

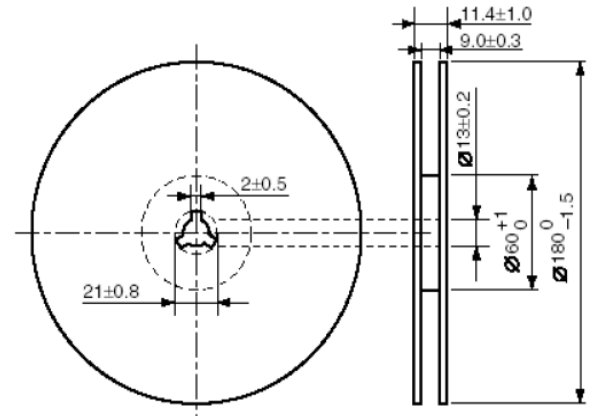
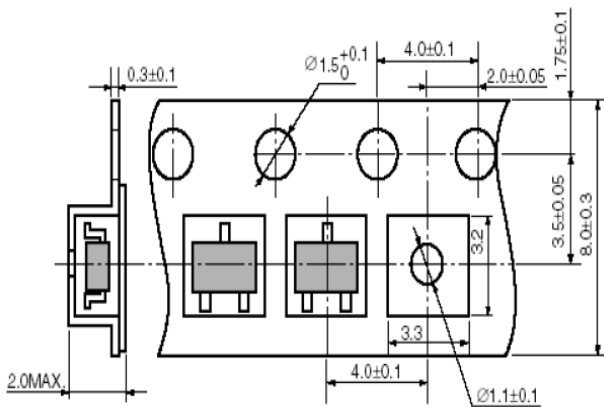



IMPORTANT NOTICE

AiT Semiconductor Inc. (AiT) reserves the right to make changes to any its product, specifications, to discontinue any integrated circuit product or service without notice, and advises its customers to obtain the latest version of relevant information to verify, before placing orders, that the information being relied on is current.

AiT Semiconductor Inc.'s integrated circuit products are not designed, intended, authorized, or warranted to be suitable for use in life support applications, devices or systems or other critical applications. Use of AiT products in such applications is understood to be fully at the risk of the customer. As used herein may involve potential risks of death, personal injury, or severe property, or environmental damage. In order to minimize risks associated with the customer's applications, the customer should provide adequate design and operating safeguards.

AiT Semiconductor Inc. assumes to no liability to customer product design or application support. AiT warrants the performance of its products of the specifications applicable at the time of sale.