

Low Operating Voltage, High f_T Bipolar Microwave Transistors

MP4T6365

V2.00

Features

- Designed for Battery Operation
- f_T to 10 GHz
- Low Voltage Oscillator and Amplifier
- Low Phase Noise and Noise Figure
- Hermetic and Surface Mount Packages and Chips Available
- Can be Screened to JANTX, JANTXV Equivalent Levels

Description

The MP4T6365 family of low voltage, high gain bandwidth silicon NPN bipolar transistors provides low noise figure and high gain at low bias voltages. These transistors are especially attractive for low operating voltage low noise amplifiers or driver amplifiers at frequencies to 4 GHz. They are also useful for low phase noise local oscillators and VCOs in battery operated equipment to 10 GHz.

The MP4T6365 family was designed to have low noise figure at operating voltages as low as 3 volts. These transistors also exhibit low phase noise in VCOs operating at 5 volts or less.

Because this transistor family was specifically designed to operate from low bias voltage, it has superior phase noise in comparison to similar current bipolar transistors with higher collector breakdown voltage when operating under the same low voltage conditions.

The MP4T6365 series transistors are available in hermetic Micro-X packages, the SOT-23, the SOT-143, and in chip form (MP4T636500). Other stripline and hermetic packages are available. The chip and hermetic packages can be screened to JANTX, JANTXV equivalent levels. The plastic parts can be supplied on tape and reel.

All of M-Pulse's silicon bipolar transistor families use silicon dioxide and silicon nitride passivation to assure low 1/F noise for amplifier and oscillator applications.

Case Styles

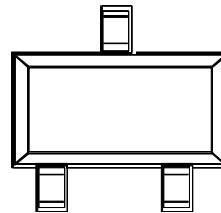

SOT-23

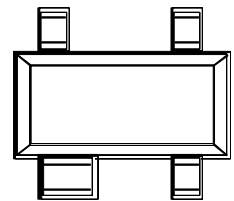

SOT-143

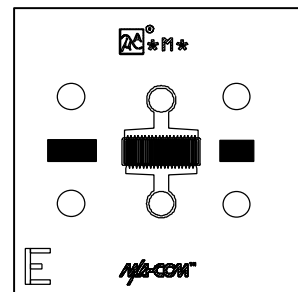

Chip

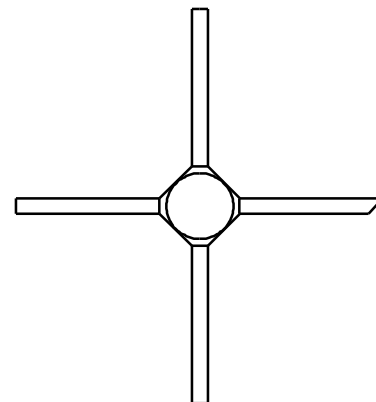

Micro-X

Specification Subject to Change Without Notice

Maximum Ratings ($T_A = 25^\circ\text{C}$)
MP4T6365 Series

Collector-Base Voltage	V_{CBO}	10 V
Collector-Emitter Voltage	V_{CE}	6 V
Emitter-Base Voltage	V_{EB}	1.5 V
Collector Current	I_C	65 mA
Junction Operating Temperature	T_j	200°C
Storage Temperature Chip or Ceramic Packages Plastic Packages	T_s	-65°C to +200°C -65°C to +125°C
Power Dissipation		
Package Type	Maximum Dissipation @ 25°C	Maximum Operating Temperature
Chip (MP4T636500)	400 mW	175°C
SOT-23 (MP4T636533)	200 mW	125°C
Micro-X Package (MP4T636535)	300 mW	150°C
SOT-143 (MP4T636539)	225 mW	125°C

Electrical Specifications @ 25°C
MP4T6365 Series

Parameter of Test	Condition	Symbol	Units	MP4T636500	MP4T636535	MP4T636539	MP4T636533
				Chip	Micro-X	SOT-143	SOT-23
Gain Bandwidth Product	$V_{CE} = 3\text{ V}$ $I_C = 20\text{ mA}$	f_T	GHz	10 typ	10 typ	10 typ	10 typ
Insertion Power Gain	$V_{CE} = 3\text{ V}$ $I_C = 10\text{ mA}$ $f = 1\text{ GHz}$ $f = 2\text{ GHz}$	$ S_{21E} ^2$	dB	14 typ 7.0 min	13 typ 7.0 min	13 typ 7.0 min	13 typ 7.0 min
Noise Figure	$V_{CE} = 3\text{ V}$ $I_C = 5\text{ mA}$ $f = 1\text{ GHz}$ $f = 2\text{ GHz}$	NF	dB	1.3 typ 1.6 typ	1.3 typ 1.6 typ	1.4 typ 1.7 typ	1.4 typ 1.7 typ
Unilateral Gain	$V_{CE} = 3\text{ V}$ $I_C = 5\text{ mA}$ $f = 1\text{ GHz}$ $f = 2\text{ GHz}$	GTU (max)	dB	15 typ 10 typ	15 typ 10 typ	14 typ 9 typ	14 typ 9 typ
Maximum Available Gain	$V_{CE} = 3\text{ V}$ $I_C = 20\text{ mA}$ $f = 1\text{ GHz}$ $f = 2\text{ GHz}$	MAG	dB	16 typ 12 typ	16 typ 11 typ	16 typ 10 typ	16 typ 10 typ
Output Power at 1 dB Compression	$V_{CE} = 3\text{ V}$ $I_C = 20\text{ mA}$ $f = 2\text{ GHz}$ $f = 4\text{ GHz}$	P_{1dB}	dBm	16 typ 12 typ	17 typ 13 typ	16 typ 12 typ	16 typ 12 typ

Specification Subject to Change Without Notice

Electrical Specifications @ 25°C

Parameter	Condition	Symbol	Min	Typical	Max	Units
Collector Cut-off Current	$V_{CB} = 3$ volts $I_E = 0$ μ A	I_{CBO}	—	—	100	μ A
Emitter Cut-off Current	$V_{EB} = 1$ volt $I_C = 0$ μ A	I_{EBO}	—	—	1	μ A
Forward Current Gain	$V_{CE} = 3$ volts $I_C = 5$ mA	h_{FE}	30	75	200	—
Collector-Base Junction Capacitance	$V_{CB} = 5$ volts $I_E = 0$ μ A $f = 1$ MHz	C_{OB}	—	0.50	0.70	pF

Typical Common Emitter Scattering Parameters in the Micro-X Package

MP4T636535, $V_{CE} = 3$ Volts, $I_C = 5$ mA

Frequency (MHz)	S_{11E}		S_{21E}		S_{12E}		S_{22E}	
	Mag.	Angle	Mag.	Angle	Mag.	Angle	Mag	Angle
500	0.640	-103	6.343	116.9	0.103	38.7	0.534	-75.2
1000	0.580	-153	3.984	91.5	0.123	29.0	0.346	-103.0
1500	0.571	-175	2.813	77.9	0.135	27.7	0.250	-124.9
2000	0.590	168	2.214	67.0	0.146	26.8	0.242	-140.4
2500	0.597	155	1.853	57.9	0.159	27.3	0.211	-150.2
3000	0.622	144	1.632	48.2	0.174	27.3	0.227	-164.1
3500	0.646	134	1.460	40.1	0.190	26.8	0.229	-168.0
4000	0.676	124	1.341	31.7	0.205	25.6	0.238	170.7
4500	0.712	115	1.241	23.7	0.218	24.1	0.255	167.9
5000	0.750	106	1.191	16.4	0.238	22.2	0.277	157.8
5500	0.793	96	1.130	8.4	0.257	20.2	0.310	153.0
6000	0.833	88	1.081	2.5	0.272	17.3	0.323	145.0

MP4T636535, $V_{CE} = 3$ Volts, $I_C = 10$ mA

Frequency (MHz)	S_{11E}		S_{21E}		S_{12E}		S_{22E}	
	Mag.	Angle	Mag.	Angle	Mag.	Angle	Mag	Angle
500	0.580	-142	8.562	104.6	0.066	39.1	0.389	-102.8
1000	0.589	-175	4.641	85.8	0.086	40.5	0.274	-132.0
1500	0.592	170	3.200	75.1	0.106	42.9	0.228	-158.1
2000	0.617	157	2.480	65.9	0.125	43.0	0.243	-169.4
2500	0.625	146	2.069	57.9	0.150	42.7	0.220	171.9
3000	0.652	136	1.811	48.9	0.172	40.8	0.250	166.9
3500	0.676	127	1.613	41.3	0.195	38.3	0.251	161.4
4000	0.707	118	1.479	33.3	0.218	35.1	0.270	150.2
4500	0.741	109	1.366	25.6	0.234	31.9	0.281	146.1
5000	0.776	100	1.311	18.5	0.259	28.1	0.311	135.9
5500	0.817	91	1.240	10.6	0.281	24.9	0.342	132.5
6000	0.855	82	1.118	3.0	0.298	20.5	0.351	125.1

Specification Subject to Change Without Notice

Typical Common Emitter Scattering Parameters in the Micro-X Package (Cont'd)

MP4T636535, $V_{CE} = 3$ Volts, $I_C = 20$ mA

Frequency (MHz)	S_{11E}		S_{21E}		S_{12E}		S_{22E}	
	Mag.	Angle	Mag.	Angle	Mag.	Angle	Mag.	Angle
500	0.551	-160	9.374	99.1	0.048	46.7	0.321	-111.2
1000	0.567	177	4.916	84.2	0.071	52.5	0.238	-139.5
1500	0.577	164	3.373	74.7	0.094	54.2	0.217	-161.0
2000	0.599	153	2.613	66.4	0.117	53.2	0.223	-171.4
2500	0.611	143	2.174	58.9	0.144	52.0	0.214	168.4
3000	0.633	133	1.898	50.6	0.169	49.2	0.232	163.6
3500	0.659	125	1.690	43.4	0.194	45.9	0.242	159.3
4000	0.689	116	1.552	35.8	0.219	42.1	0.256	149.4
4500	0.724	107	1.444	28.4	0.238	38.3	0.274	144.3
5000	0.758	99	1.378	21.4	0.263	33.9	0.294	135.8
5500	0.800	90	1.309	13.5	0.287	30.0	0.319	130.4
6000	0.840	82	1.252	6.0	0.304	25.3	0.333	124.2

MP4T636535, $V_{CE} = 3$ Volts, $I_C = 40$ mA

Frequency (MHz)	S_{11E}		S_{21E}		S_{12E}		S_{22E}	
	Mag.	Angle	Mag.	Angle	Mag.	Angle	Mag.	Angle
500	0.589	-173	9.150	93.6	0.044	55.7	0.275	-120.0
1000	0.604	141	5.202	80.8	0.067	59.2	0.220	-147.2
1500	0.620	159	3.505	70.8	0.094	58.6	0.210	-164.0
2000	0.642	149	2.685	62.2	0.119	56.4	0.210	174.3
2500	0.666	138	2.218	54.1	0.145	53.8	0.212	171.8
3000	0.681	128	1.935	45.9	0.172	50.0	0.220	168.3
3500	0.704	119	1.710	37.6	0.195	46.0	0.234	161.2
4000	0.738	110	1.560	29.8	0.218	41.9	0.248	153.7
4500	0.777	101	1.445	22.3	0.240	37.8	0.265	147.0
5000	0.819	92	1.365	14.5	0.262	33.7	0.283	140.6
5500	0.858	82	1.290	6.7	0.284	29.9	0.301	134.8
6000	0.896	73	1.228	-1.4	0.305	25.5	0.328	128.3

MP4T636535, $V_{CE} = 3$ Volts, $I_C = 60$ mA

Frequency (MHz)	S_{11E}		S_{21E}		S_{12E}		S_{22E}	
	Mag.	Angle	Mag.	Angle	Mag.	Angle	Mag.	Angle
500	0.604	-179	8.203	92.9	0.040	60.9	0.242	-112.0
1000	0.614	167	4.730	80.5	0.084	63.6	0.189	-139.1
1500	0.631	156	3.220	69.9	0.091	61.8	0.182	-155.9
2000	0.655	146	2.480	60.6	0.116	59.0	0.181	-168.3
2500	0.681	135	2.048	51.8	0.141	55.8	0.182	-172.5
3000	0.697	125	1.778	43.3	0.166	51.9	0.190	-174.3
3500	0.721	116	1.573	34.8	0.189	47.9	0.204	170.8
4000	0.758	107	1.430	26.8	0.211	43.9	0.217	164.7
4500	0.798	97	1.325	19.3	0.232	40.0	0.234	158.5
5000	0.843	88	1.255	11.4	0.254	36.2	0.253	152.9
5500	0.883	79	1.190	3.3	0.279	32.4	0.278	146.6
6000	0.922	69	1.125	-5.2	0.298	27.6	0.300	138.4

Specification Subject to Change Without Notice

MP4T6365

Typical Performance Curves

POWER DERATING CURVES

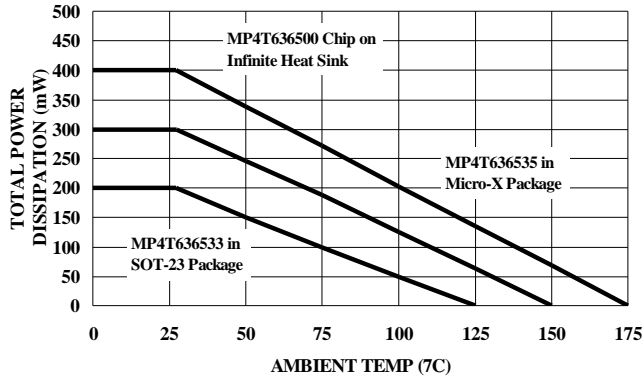

NOMINAL COLLECTOR-BASE CAPACITANCE (C_{OB}) vs COLLECTOR-BASE VOLTAGE (MP4T636535)

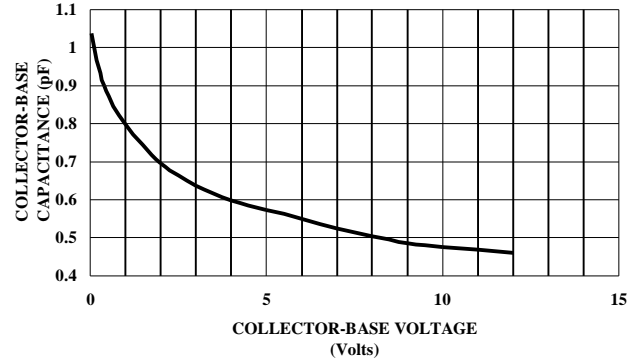

NOMINAL GAIN vs FREQUENCY at $V_{CE} = 3$ Volts, $I_C = 10$ mA (MP4T636535)

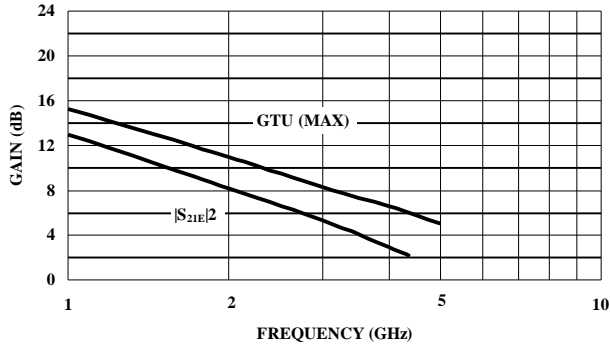

NOMINAL GAIN vs COLLECTOR CURRENT at $f = 1.0$ GHz, $V_{CE} = 3$ Volts (MP4T636535)

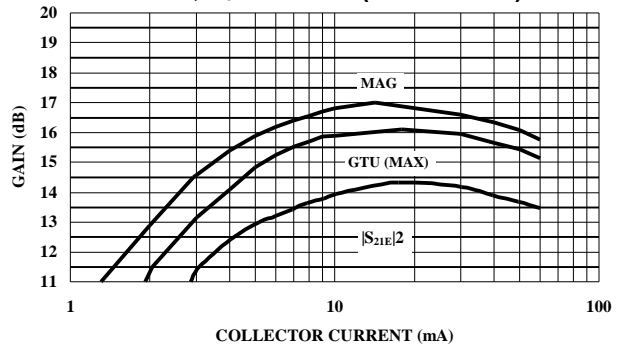

Specification Subject to Change Without Notice

Typical Performance Curves (Cont'd)

NOMINAL GAIN BANDWIDTH PRODUCT (f_T) vs COLLECTOR CURRENT at $V_{CE} = 3$ VOLTS (MP4T636535)

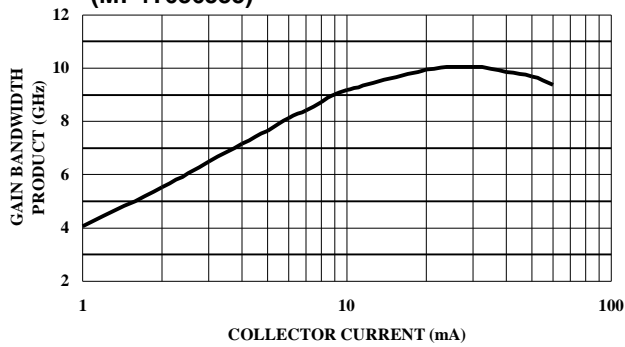

NOMINAL DC CURRENT GAIN (h_{FE}) vs COLLECTOR CURRENT at $V_{CE} = 3$ VOLTS (MP4T636535)

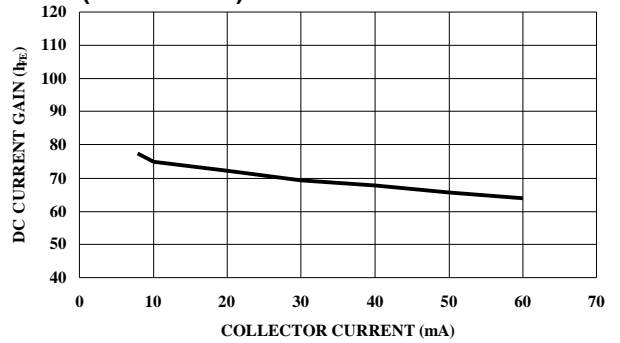

NOMINAL NOISE FIGURE and ASSOCIATED GAIN vs FREQUENCY at $V_{CE} = 3$ VOLTS, COLLECTOR CURRENT = 5 mA (MP4T636535)

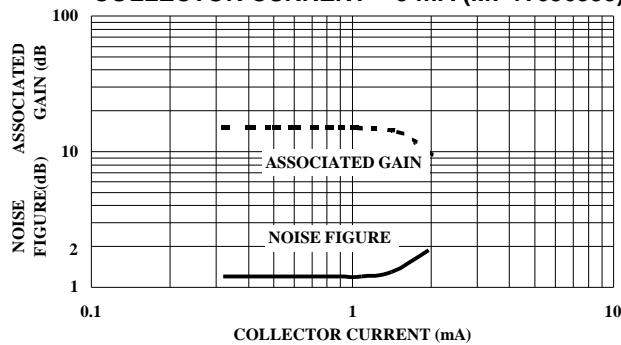

NOMINAL NOISE FIGURE and ASSOCIATED GAIN at $V_{CE} = 3$ VOLTS, and 1 GHz vs the COLLECTOR CURRENT (MP4T636535)

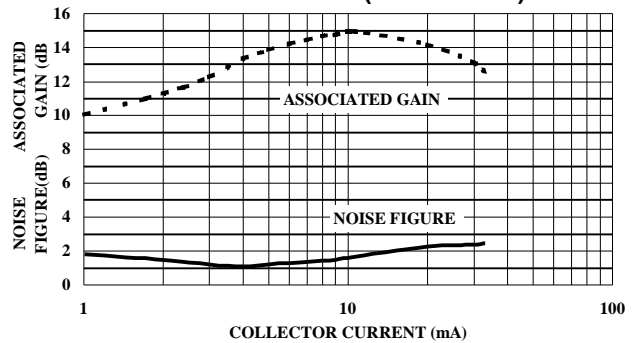

Specification Subject to Change Without Notice

Typical Performance Curves (Cont'd)

NOMINAL OUTPUT POWER at the 1dB COMPRESSION POINT vs COLLECTOR CURRENT at $f = 2$ and 4 GHz, $V_{CE} = 3$ VOLTS (MP4T636535)

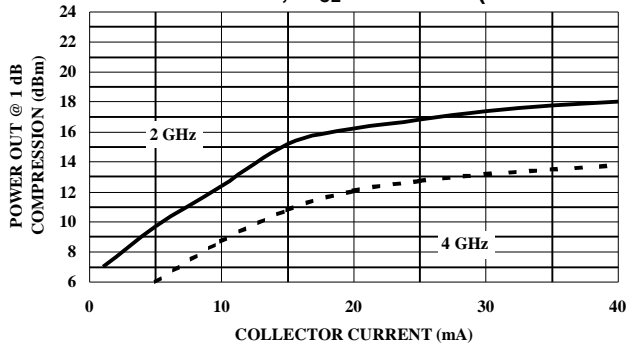

Case Styles

SOT-23 $\frac{3}{4}$ MA4T636533

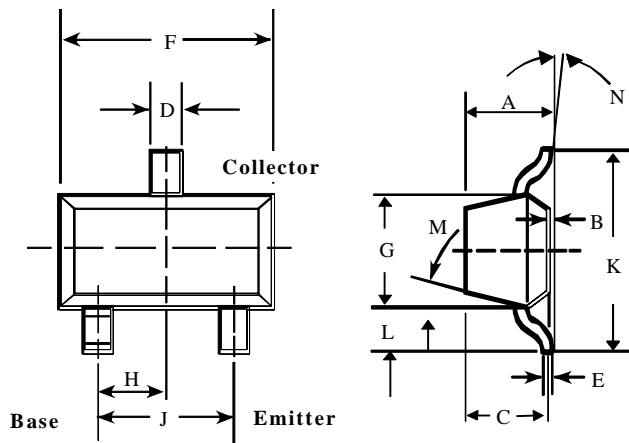

MP4T636533

DIM.	INCHES		MILLIMETERS	
	MIN.	MAX.	MIN.	MAX.
A	—	0.044	—	1.12
B	—	0.004	—	0.10
C	—	0.040	—	1.00
D	0.013	0.020	0.35	0.50
E	0.003	0.006	0.08	0.15
F	0.110	0.119	2.80	3.00
G	0.047	0.056	1.20	1.40
H	0.037 typical		0.95 typical	
J	0.075 typical		1.90 typical	
K	—	0.103	—	2.60
L	—	0.024	—	0.60

DIM.	GRADIENT
M	10° max. ¹
N	2° ... 30°

NOTE:

1. Applicable on all sides

Specification Subject to Change Without Notice

Case Styles (Cont'd)

Micro-X $\frac{3}{4}$ MP4T636535

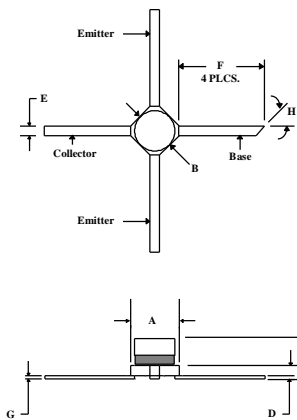

MP4T636535

DIM.	INCHES		MILLIMETERS	
	MIN.	MAX.	MIN.	MAX.
A	0.092	0.108	2.34	2.74
B	0.079	0.087	2.01	2.21
C	—	0.070	—	1.78
D	0.019	0.025	0.48	0.64
E	0.018	0.022	0.46	0.56
F	0.150	—	3.81	—
G	0.003	0.006	0.08	0.15
H	45°		45°	

MP4T636500

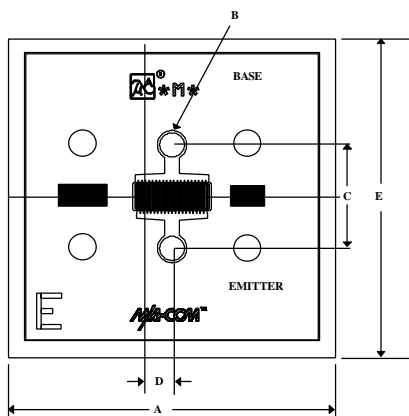

MP4T636500

DIM.	INCHES	MILLIMETERS
A	0.013	0.325
B (Dia.) 2 plcs.	0.0012	0.030
C	0.004	0.110
D	0.0005	0.013
E	0.013	0.325
F (chip thickness)	0.0045	0.114

Case Style SOT-143 $\frac{3}{4}$ MP4T636539

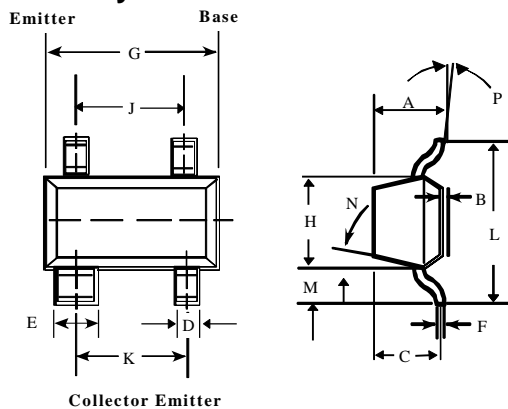

MP4T636539

DIM.	INCHES		MILLIMETERS	
	MIN.	MAX.	MIN.	MAX.
A	—	0.044	—	1.10
B	—	0.004	—	0.10
C	—	0.040	—	1.00
D	0.030	0.035	0.75	0.90
E	0.013	0.020	0.35	0.50
F	0.003	0.006	0.08	0.15
G	0.110	0.119	2.80	3.00
H	0.047	0.056	1.20	1.40
J	0.075 typical		1.90 typical	
K	0.040 typical		1.70 typical	
L	—	0.103	—	2.60
M	—	0.024	—	0.60

DIM.	GRADIENT
N	10° max. ¹
P	2° ... 30°

NOTE:
1. Applicable on all sides

Specification Subject to Change Without Notice

M-Pulse Microwave
576 Charcot Avenue, San Jose, California 95131

Tel (408) 432-1480

Fax (408) 432-3440