

Power Modules - Thyristor/Diode

FEATURES

- High surge capability
- Qualified for industrial level
- Thick copper baseplate
- Easy mounting on heatsink
- International standard TO-240AA

TYPICAL APPLICATIONS

- Power supplies
- Machine tools control
- High power drives
- Welders
- Medium traction

MAJOR RATINGS AND CHARACTERISTICS			
PARAMETER	TEST CONDITIONS	VALUES	UNITS
$I_{T(AV)}, I_{F(AV)}$		55	A
	T_{Case}	85	°C
$I_{T(RMS)}, I_{F(RMS)}$		122	A
	T_{Case}	85	°C
I_{TSM}, I_{FSM}	50 Hz	1260	A
	60 Hz	1370	A
I^2t	50 Hz	7.17	kA ² s
	60 Hz	7.81	kA ² s
V_{DRM}/V_{RRM}		200 to 1600	V
t_q	Typical	125	µs
T_J		-40 to 125	°C

ELECTRICAL SPECIFICATIONS

VOLTAGE RATINGS				
SERIES	VOLTAGE CODE	V _{DRM} /V _{RRM} , MAX. RE- PETITIVE PEAK AND OFF-STATE VOLTAGE	V _{RSM} , MAX. NON- REPETITIVE PEAK VOLTAGE (V)	I _{DRM} /I _{RRM} , MAX. at T _J = T _{J(Max.)} (mA)
TD55/...	02	200	300	15
TD55/...	04	400	500	
TD55/...	06	600	700	
TD55/...	08	800	900	
TD55/...	10	1000	1100	
TD55/...	12	1200	1300	
TD55/...	14	1330	1500	
TD55/...	16	1520	1700	

Revision: 03.07.2010

www.komkraft.com.br

Power Modules - Thyristor/Diode

MAXIMUM ALLOWABLE RATINGS					
SYMBOL	DESCRIPTION	TEST CONDITIONS		VALUE	UNITS
$I_{T,F(AV)}$	Maximum average on-state current at heatsink temperature	180° conduction, half sine wave		55	A
				85	°C
$I_{T,F(RMS)}$	Maximum RMS on-state current	DC at 25°C heatsink temperature		122	A
I_{TSM}, I_{FSM}	Maximum peak, one-cycle non-repetitive surge current	t = 10 ms	100% V_{RRM} reapplied	Sinusoidal half wave, initial $T_j = T_j \text{ max.}$	1.10
		t = 8.3 ms	100% V_{RRM} reapplied		1.20
		t = 10 ms	No voltage reapplied		1.26
		t = 8.3 ms	No voltage reapplied		1.37
I^2t	Maximum I^2t	t = 10 ms	100% V_{RRM} reapplied		6.29
		t = 8.3 ms	100% V_{RRM} reapplied		6.85
		t = 10 ms	No voltage reapplied		7.17
		t = 8.3 ms	No voltage reapplied		7.81
$I^2t^{1/2}$	Maximum $I^2t^{1/2}$	t = 0.1 to 10 ms, no voltage reapplied		85.60	$\text{kA}^2\text{s}^{1/2}$
$V_{T,F(T0)}$	Low level threshold voltage	(16.7% $\times \pi \times I_{T(AV)} < I < \pi \times I_{T(AV)}$), $T_j = T_j \text{ max.}$		0.89	V
r_T	Low level on-state slope resistance			3.68	mΩ
V_{TM}, V_{FM}	Maximum on-state voltage	$I_{pk} = 173\text{A}$, 50Hz half sine pulse, $T_j = T_j \text{ max.}$		1.47	V
I_H	Maximum holding current	$T_j = 25^\circ\text{C}$, anode supply 12V resistive load		200	mA
I_L	Typical latching current			400	

SWITCHING					
SYMBOL	DESCRIPTION	TEST CONDITIONS		VALUE	UNITS
dI/dt	Maximum non-repetitive rate of rise of turned-on current	Gate drive 20 V, 20 Ω, $t_r \leq 1 \mu\text{s}$, $T_j = T_j \text{ max.}$, anode voltage $\leq 80\%$ V_{DRM}		150	A/ μs
t_d	Typical delay time	Gate current 1 A, $dI_g/dt = 1 \text{ A}/\mu\text{s}$, $V_d = 0.67\%$ V_{DRM} , $T_j = 25^\circ\text{C}$		0.7	μs
t_q	Typical turn-off time			125	

BLOCKING					
SYMBOL	DESCRIPTION	TEST CONDITIONS		VALUE	UNITS
dV/dt	Maximum critical rate of rise of off-state voltage	$T_j = T_j \text{ max.}$ Linear to 80% rated V_{DRM}		500	V/ μs
I_{RRM}, I_{DRM}	Maximum peak reverse and off-state leakage current	$T_j = T_j \text{ max.}$, rated V_{DRM}/V_{RRM} applied		15	mA

Power Modules - Thyristor/Diode

TRIGGERING						
SYMBOL	DESCRIPTION	TEST CONDITIONS		VALUE		UNITS
				TYP.	MAX.	
P_{GM}	Maximum peak gate power	$T_J = T_J \text{ max.}, t_p \leq 5\text{ms}$		10		W
$P_{G(AV)}$	Maximum average gate power	$T_J = T_J \text{ max.}, f = 50\text{Hz}, d\% = 50$		3		
I_{GM}	Maximum peak gate current	$T_J = T_J \text{ max.}, t_p \leq 5\text{ms}$		1		A
$-V_{GM}$	Maximum negative gate voltage	$T_J = T_J \text{ max.}, t_p \leq 5\text{ms}$		2		V
I_{GT}	DC gate current to trigger	$T_J = -40^\circ\text{C}$	Maximum required gate trigger/current/voltage are the lowest values which will trigger all units, 12V anode to cathode applied	-	300	mA
		$T_J = 25^\circ\text{C}$		80	150	
V_{GT}	DC gate voltage to trigger	$T_J = -40^\circ\text{C}$		-	4	V
		$T_J = 25^\circ\text{C}$		-	2	
V_{GD}	DC gate voltage not to trigger	$T_J = T_J \text{ max.}$	Maximum gate current/voltage not to trigger is the maximum value which will not trigger any unit with rated V_{DRM} anode to cathode applied	0.2		V

THERMAL AND MECHANICAL SPECIFICATIONS					
SYMBOL	DESCRIPTION	TEST CONDITIONS	VALUE	UNITS	
T_J	Maximum operating junction temperature	-	-40 to 125	°C	
T_{Stg}	Maximum storage temperature	-	-40 to 150		
R_{thJ-hs}	Maximum thermal resistance, junction to heatsink	DC	0.250	°C/W	
		180° sine wave	0.261		
		120° rectangular wave	0.273		
R_{thC-hs}	Maximum thermal resistance, case to heat-sink	Mtg. Surface smooth, flat, greased	0.100		
-	Mounting force, $\pm 10\%$	To terminal (To heatsink)	3(5)	N.m	
-	Approximate weight	-	110	g	
-	Case style	-	TO-240AA	JEDEC	

CURRENT FORM FACTOR								
FORM FACTOR	CONDUCTION ANGLE	15°	30°	45°	60°	90°	120°	180°
		Sine wave		31.956	15.832	10.452	7.721	4.933
Rectangular wave		24.000	12.000	8.000	6.000	4.000	3.000	2.000

Power Modules - Thyristor/Diode

CURRENT RATINGS CHARACTERISTICS

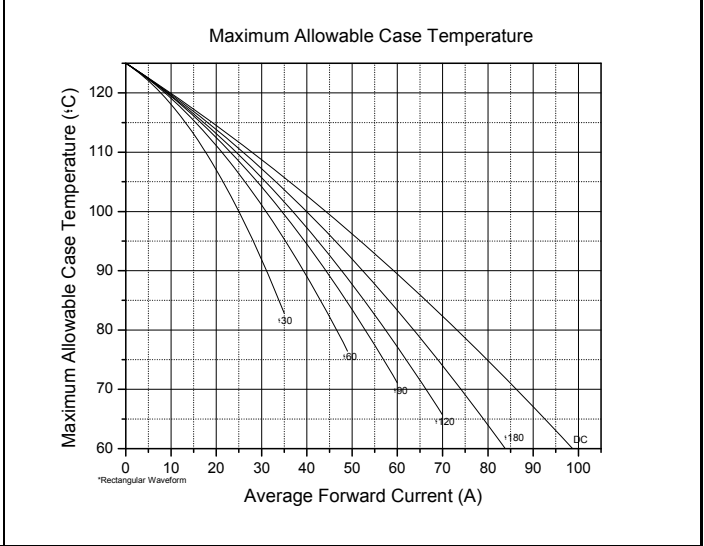
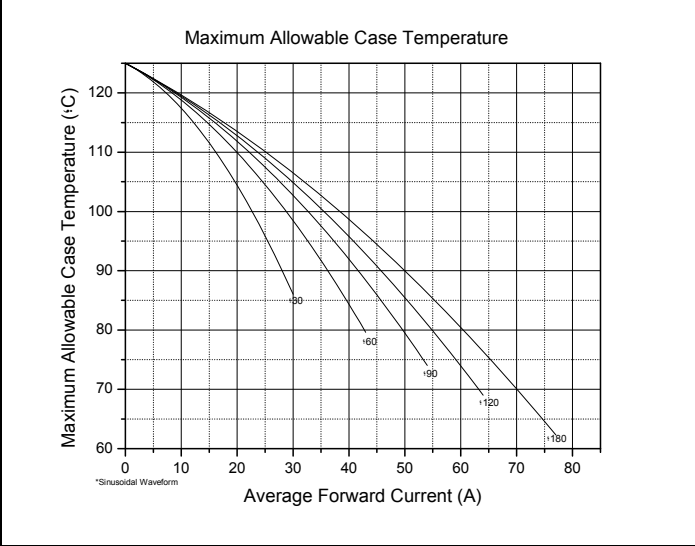

ON-STATE POWER LOSS CHARACTERISTICS

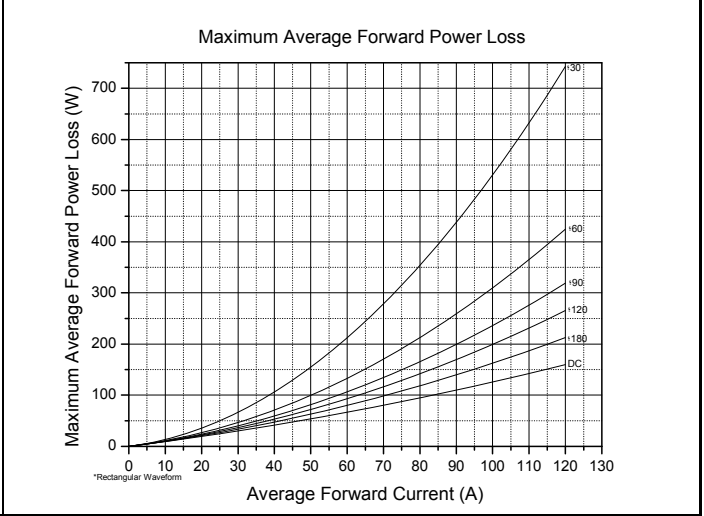
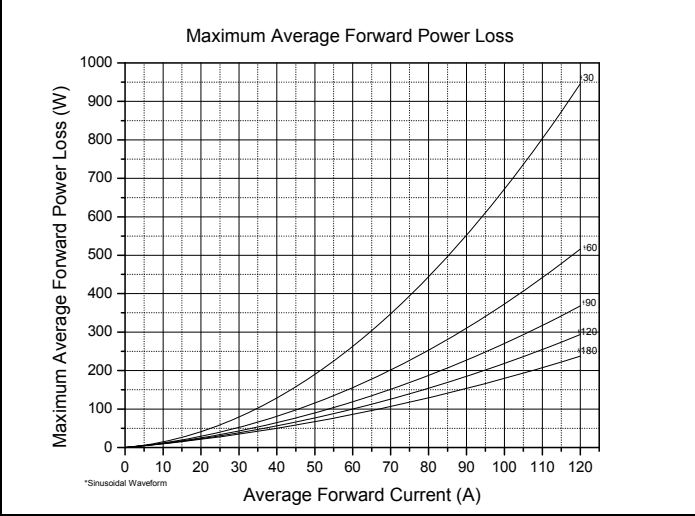

Power Modules - Thyristor/Diode

FORWARD VOLTAGE DROP / THERMAL IMPEDANCE CHARACTERISTICS

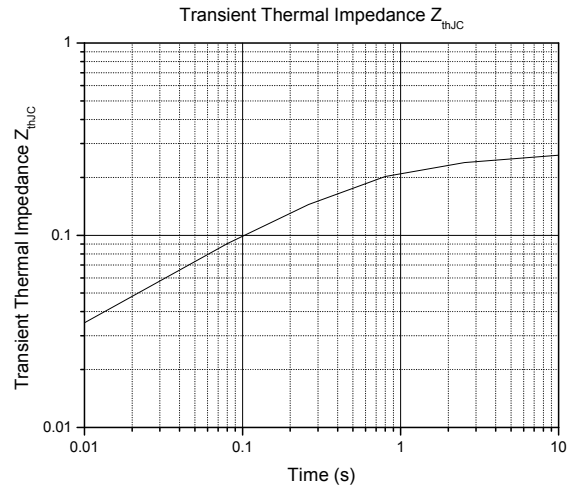
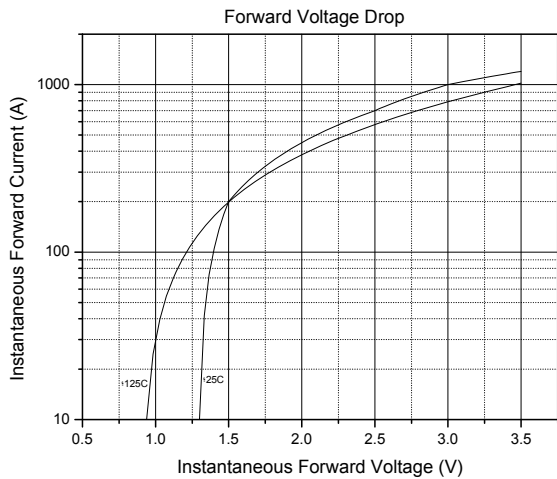

GATE TRIGGER / OUTLINE CHARACTERISTICS

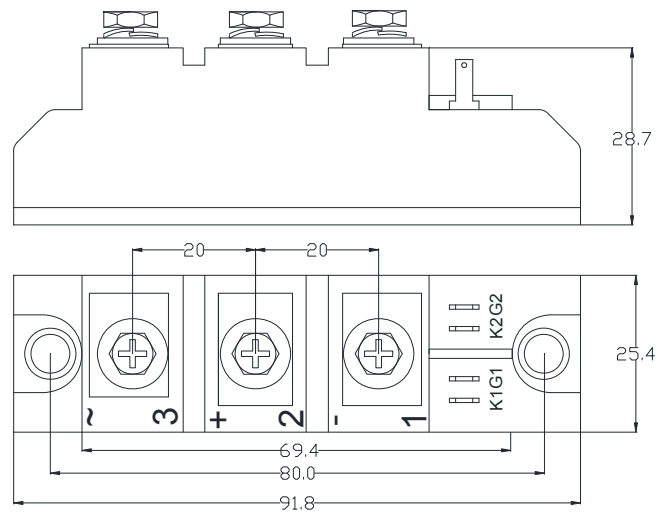
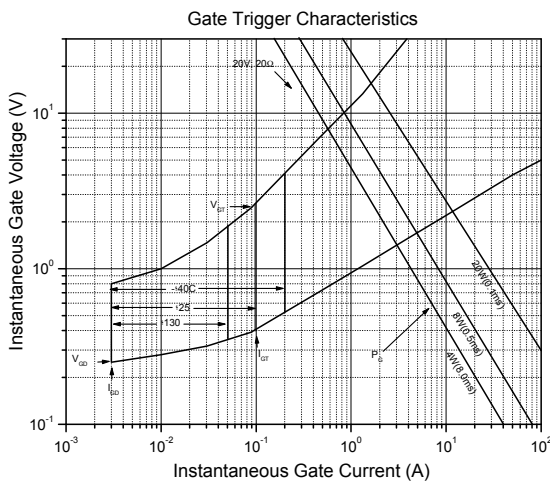

CIRCUIT CONFIGURATION

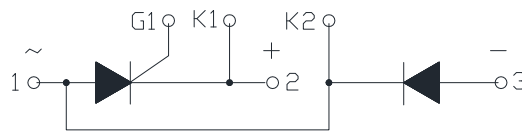

Power Modules - Thyristor/Diode

ORDERING INFORMATION

Device code

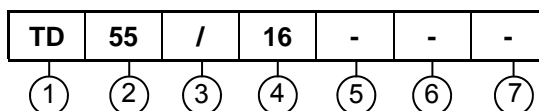

- | | |
|---|--|
| 1 | <ul style="list-style-type: none"> - N = Phase Control Thyristors - F = Fast Thyristors (inverter grade) - D = Normal Recovery Diodes - DF = Fast Recovery Diodes - DD = Module (diode-diode) - DT = Module (diode-thyristor) - TD = Module (thyristor-diode) - TT = Module (thyristor-thyristor) - P = Press-fit diode |
| 2 | <ul style="list-style-type: none"> - Average Current Code |
| 3 | <ul style="list-style-type: none"> - Essential Part Number |
| 4 | <ul style="list-style-type: none"> - Voltage Code x 100 = V_{RRM} |
| 5 | <ul style="list-style-type: none"> - Turn-off time (fast thyristors only) - Reverse Recovery Time (fast diodes only) |
| 6 | <ul style="list-style-type: none"> - M = Metric Thread - I = Inch Thread |
| 7 | <ul style="list-style-type: none"> - None = Anode to stud (stud diodes only) - R = Cathode to stud (stud diodes only) |

Disclaimer

All product specifications and data are subject to change without notice.

Komkraft Ind.Com.de Componentes Eletrônicos Ltda., its affiliates, agents and employees, and all persons acting on its or their behalf (collectively, "Komkraft"), disclaim any and all liability for any errors, inaccuracies or incompleteness contained herein or in any other disclosure relating to any product.

Komkraft disclaims any and all liability arising of the use or application of any product described herein or of any information provided herein to the maximum extent permitted by law. The product specifications do not expand or otherwise modify Komkraft's terms and conditions of purchase, including but not limited to the warranty expressed therein, which apply to these products.

The products shown herein are not designed for use in medical, life-saving or life-sustaining applications unless otherwise expressly indicated.