

Inverter Grade Thyristors

FEATURES

- Amplified gate structure
- Qualified for industrial level
- International standard case TO-200AD
- Metal case with ceramic insulator

TYPICAL APPLICATIONS

- Induction heating
- Choppers
- Inverters

MAJOR RATINGS AND CHARACTERISTICS			
PARAMETER	TEST CONDITIONS	VALUES	UNITS
$I_{T(AV)}$		1000	A
	T_{Case}	70	°C
$I_{T(RMS)}$		1580	A
	T_{Case}	70	°C
I_{TSM}	50 Hz	22100	A
	60 Hz	24000	A
I^2t	50 Hz	1514	kA ² s
	60 Hz	1650	kA ² s
V_{DRM}/V_{RRM}		200 to 2000	V
t_q	Maximum	60	µs
T_J		-40 to 125	°C

ELECTRICAL SPECIFICATIONS

VOLTAGE RATINGS				
SERIES	VOLTAGE CODE	V_{DRM}/V_{RRM} , MAX. RE- PETITIVE PEAK AND OFF-STATE VOLTAGE (V)	V_{RSM} , MAX. NON- REPETITIVE PEAK VOLTAGE (V)	I_{DRM}/I_{RRM} , MAX. at T_J = $T_{J(Max.)}$ (mA)
F1000/...	02	200	300	135
F1000/...	04	400	500	
F1000/...	06	600	700	
F1000/...	08	800	900	
F1000/...	10	1000	1100	
F1000/...	12	1200	1300	
F1000/...	14	1330	1500	
F1000/...	16	1520	1700	
F1000/...	18	1710	1900	
F1000/...	20	1900	2100	

Inverter Grade Thyristors

MAXIMUM ALLOWABLE RATINGS					
SYMBOL	DESCRIPTION	TEST CONDITIONS		VALUE	UNITS
$I_{T(AV)}$	Maximum average on-state current at heatsink temperature	180° conduction, half sine wave, double side cooled		1000	A
				70	°C
$I_{T(RMS)}$	Maximum RMS on-state current	DC at 25°C heatsink temperature, double side cooled		1580	A
I_{TSM}	Maximum peak, one-cycle non-repetitive surge current	t = 10 ms	100% V_{RRM} reapplied	Sinusoidal half wave, initial $T_J = T_J \text{ max.}$	kA
		t = 8.3 ms			
		t = 10 ms	No voltage reapplied		
		t = 8.3 ms			
I^2t	Maximum I^2t	t = 10 ms	100% V_{RRM} reapplied	1328	kA^2s
		t = 8.3 ms			
		t = 10 ms	No voltage reapplied	1514	
		t = 8.3 ms			
$I^2t^{1/2}$	Maximum $I^2t^{1/2}$	t = 0.1 to 10 ms, no voltage reapplied		25500	$\text{kA}^2\text{s}^{1/2}$
$V_{T(TO)}$	Low level threshold voltage	(16.7% $\times \pi \times I_{T(AV)} < I < \pi \times I_{T(AV)}$), $T_J = T_J \text{ max.}$		1.43	V
r_T	Low level on-state slope resistance			0.36	mΩ
V_{TM}	Maximum on-state voltage	$I_{pk} = 3142\text{A}$, 50Hz half sine pulse, $T_J = T_J \text{ max.}$		2.36	V
I_H	Maximum holding current	$T_J = 25^\circ\text{C}$, anode supply 12V resistive load		500	mA
I_L	Typical latching current			270	

SWITCHING					
SYMBOL	DESCRIPTION	TEST CONDITIONS		VALUE	UNITS
dI/dt	Maximum non-repetitive rate of rise of turned-on current	Gate drive 20 V, 20 Ω, $t_r \leq 1 \mu\text{s}$, $T_J = T_J \text{ max.}$, anode voltage $\leq 80\% V_{DRM}$		800	A/μs
t_d	Typical delay time	Gate current 1 A, $dI_g/dt = 1 \text{ A}/\mu\text{s}$, $V_d = 0.67\% V_{DRM}$, $T_J = 25^\circ\text{C}$		1.5	μs
t_q	Typical turn-off time	$T_J = 125^\circ\text{C}$, $I_{TM} = 500\text{A}$, $dI/dt = 25\text{A}/\mu\text{s}$, $V_R = 50\text{V}$, $dV/dt = 200\text{V}/\mu\text{s}$ lin. To 80% rated V_{DRM} . Gate: 0V, 100Ω		25	

BLOCKING					
SYMBOL	DESCRIPTION	TEST CONDITIONS		VALUE	UNITS
dV/dt	Maximum critical rate of rise of off-state voltage	$T_J = T_J \text{ max.}$ Linear to 80% rated V_{DRM}		700	V/μs
I_{RRM}, I_{DRM}	Maximum peak reverse and off-state leakage current	$T_J = T_J \text{ max.}$, rated V_{DRM}/V_{RRM} applied		135	mA

Inverter Grade Thyristors

TRIGGERING						
SYMBOL	DESCRIPTION	TEST CONDITIONS		VALUE		UNITS
				TYP.	MAX.	
P_{GM}	Maximum peak gate power	$T_J = T_J \text{ max.}, t_p \leq 5\text{ms}$		16		W
$P_{G(AV)}$	Maximum average gate power	$T_J = T_J \text{ max.}, f = 50\text{Hz}, d\% = 50$		3		
I_{GM}	Maximum peak gate current	$T_J = T_J \text{ max.}, t_p \leq 5\text{ms}$		2		A
$-V_{GM}$	Maximum negative gate voltage	$T_J = T_J \text{ max.}, t_p \leq 5\text{ms}$		3		V
I_{GT}	DC gate current to trigger	$T_J = -40^\circ\text{C}$	Maximum required gate trigger/current/voltage are the lowest values which will trigger all units, 12V anode to cathode applied	-	300	mA
		$T_J = 25^\circ\text{C}$		-	150	
V_{GT}	DC gate voltage to trigger	$T_J = -40^\circ\text{C}$		-	3.3	V
		$T_J = 25^\circ\text{C}$			2.5	
V_{GD}	DC gate voltage not to trigger	$T_J = T_J \text{ max.}$	Maximum gate current/voltage not to trigger is the maximum value which will not trigger any unit with rated V_{DRM} anode to cathode applied	0.3		V

THERMAL AND MECHANICAL SPECIFICATIONS					
SYMBOL	DESCRIPTION	TEST CONDITIONS	VALUE	UNITS	
T_J	Maximum operating junction temperature	-	-40 to 125	°C	
T_{Stg}	Maximum storage temperature	-	-40 to 150		
R_{thJ-hs}	Maximum thermal resistance, junction to heatsink	DC, double side cooled	0.023	°C/W	
		180° sine wave, double side cooled	0.026		
		120° rectangular wave, double side cooled	0.027		
R_{thC-hs}	Maximum thermal resistance, case to heat-sink	Mtg. Surface smooth, flat, greased, double side cooled	0.01		
-	Mounting force, $\pm 10\%$	-	2500	kgf	
-	Approximate weight	-	425	g	
-	Case style	-	TO-200AD	JEDEC	

CURRENT FORM FACTOR								
FORM FACTOR	CONDUCTION ANGLE	15°	30°	45°	60°	90°	120°	180°
		Sine wave		31.956	15.832	10.452	7.721	4.933
Rectangular wave		24.000	12.000	8.000	6.000	4.000	3.000	2.000

Inverter Grade Thyristors

CURRENT RATINGS CHARACTERISTICS

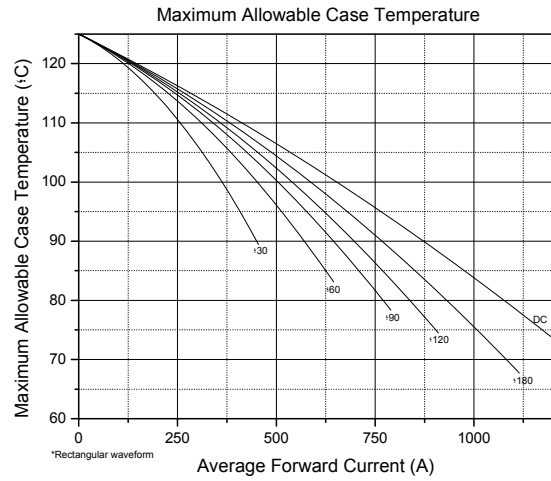
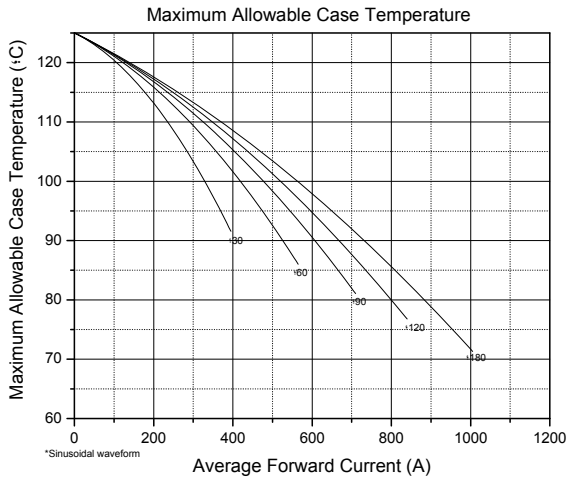

ON-STATE POWER LOSS CHARACTERISTICS

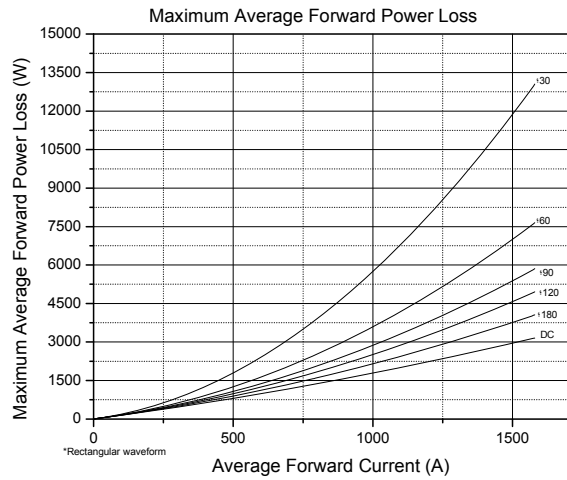
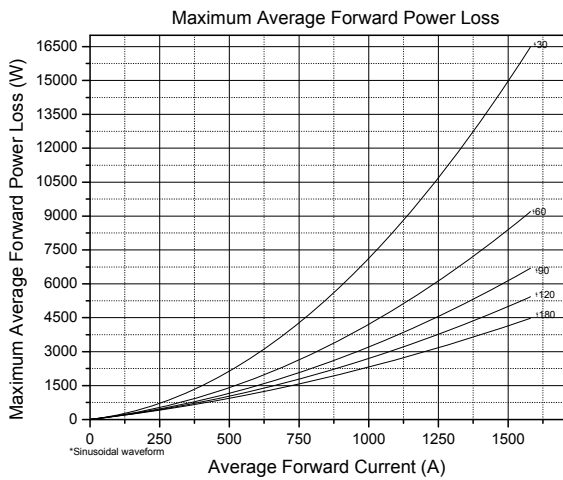

Inverter Grade Thyristors

FORWARD VOLTAGE DROP / THERMAL IMPEDANCE CHARACTERISTICS

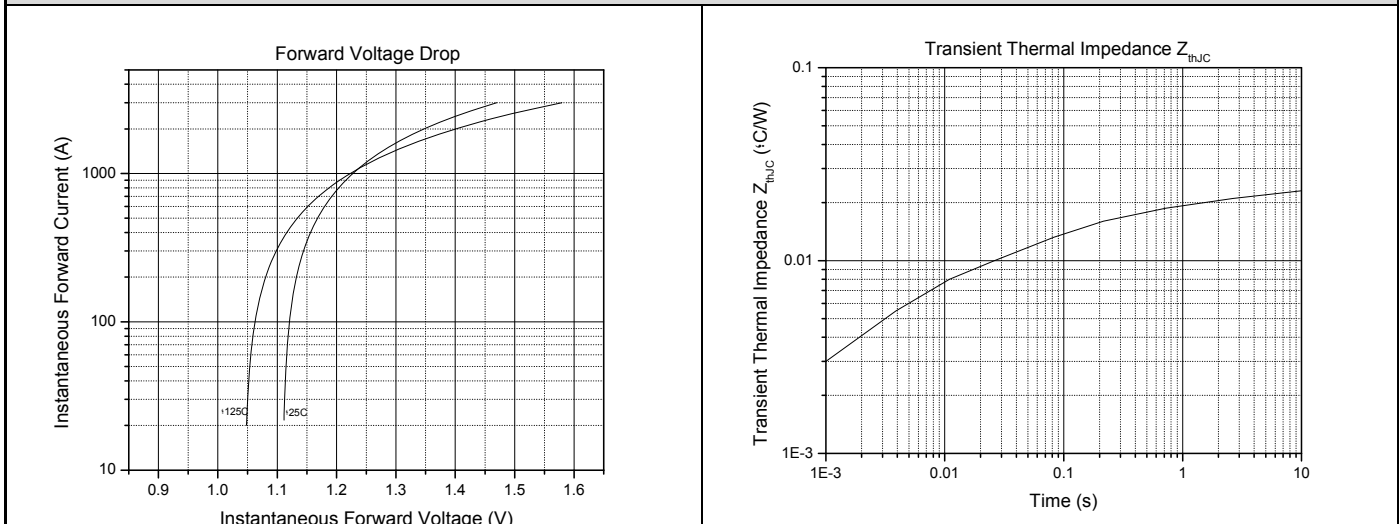

GATE TRIGGER / REVERSE RECOVERY CHARGE CHARACTERISTICS

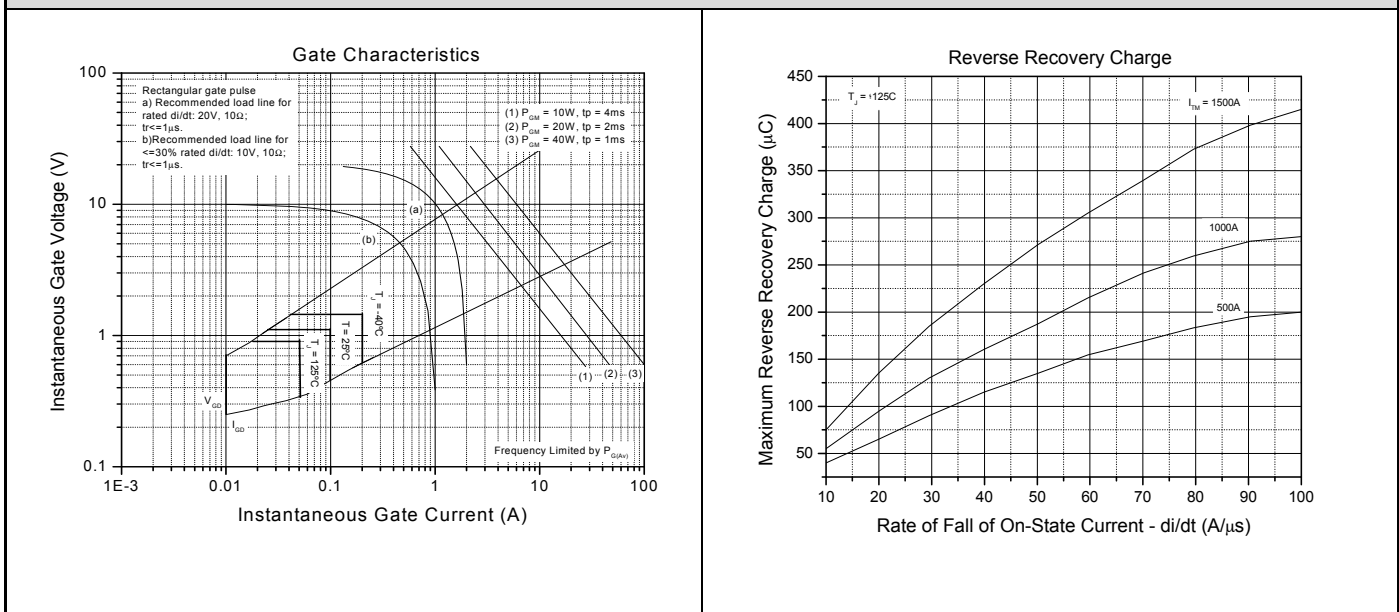

Inverter Grade Thyristors

FREQUENCY CHARACTERISTICS

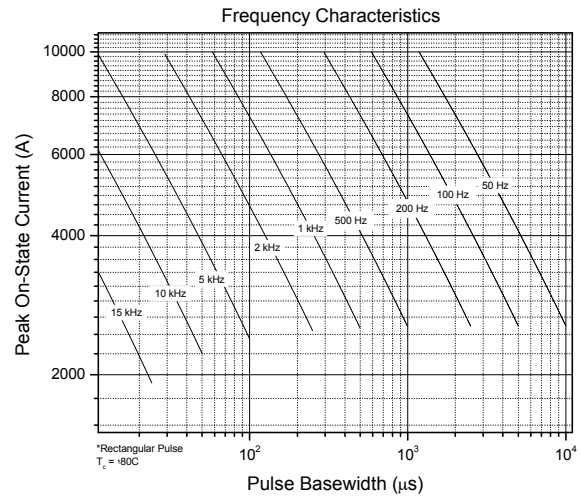
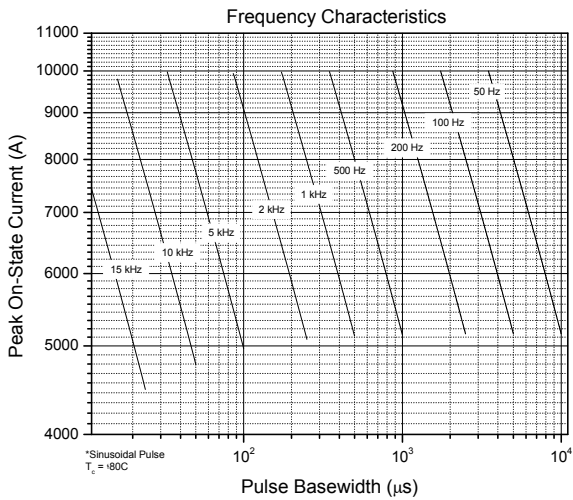
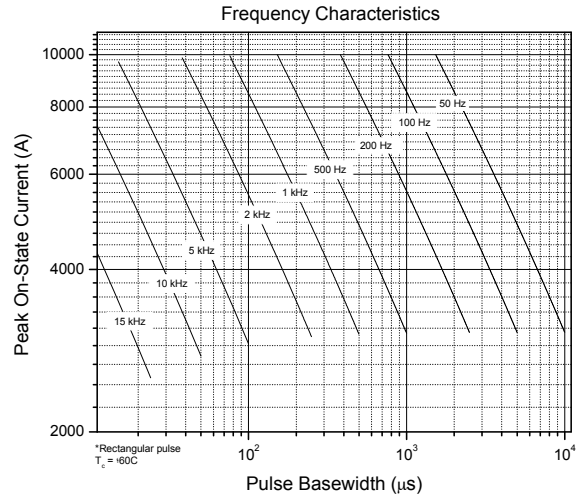
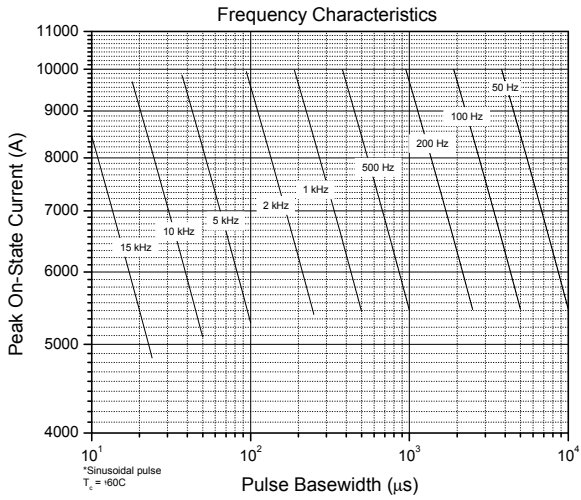

Inverter Grade Thyristors

FREQUENCY CHARACTERISTICS

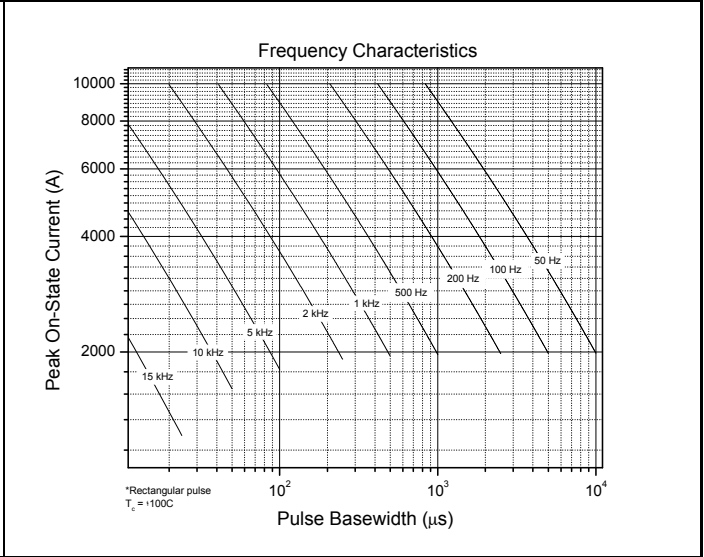
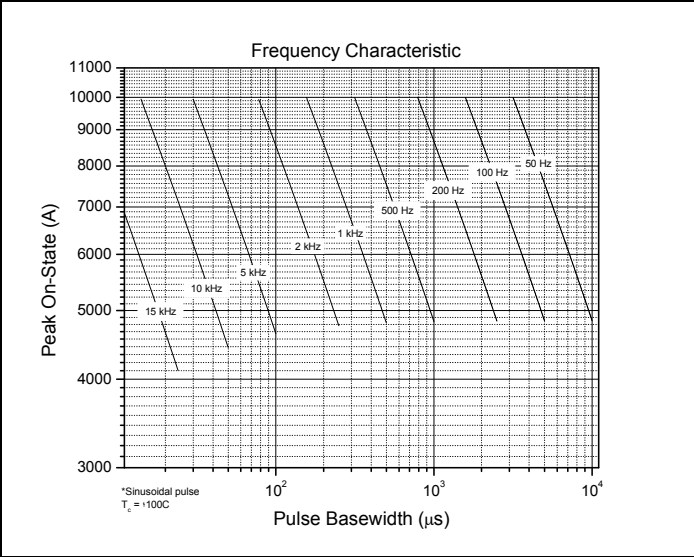

ENERGY POWER-LOSS CHARACTERISTICS

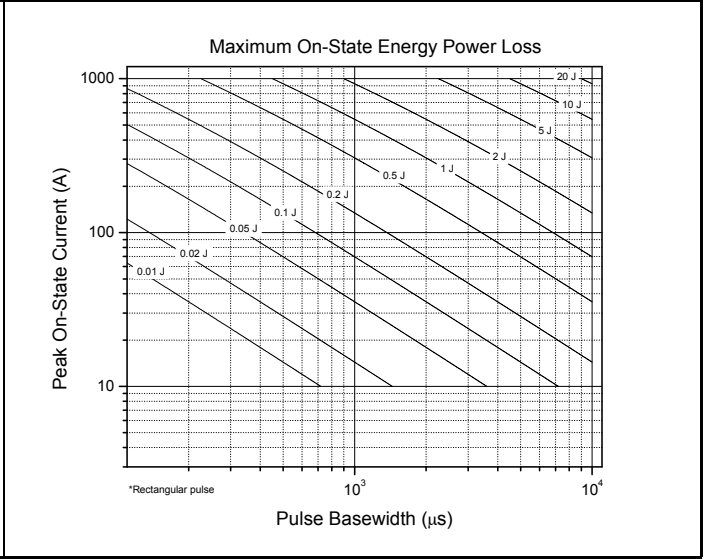
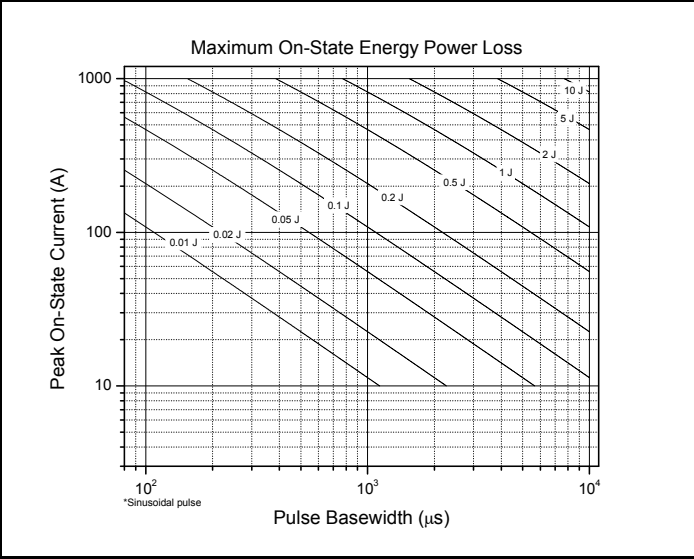

Inverter Grade Thyristors

OUTLINE CHARACTERISTICS

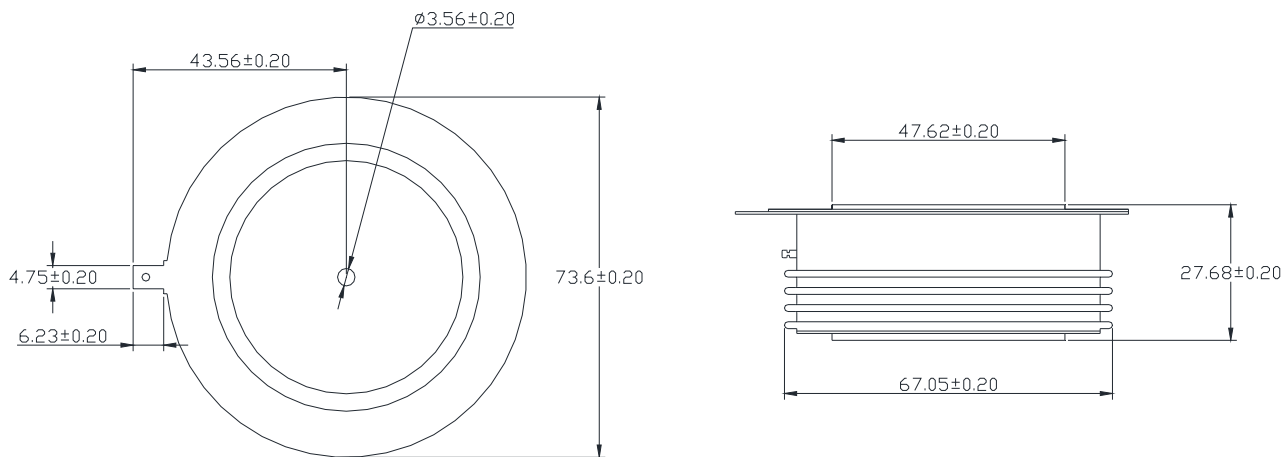

ORDERING INFORMATION

Device code

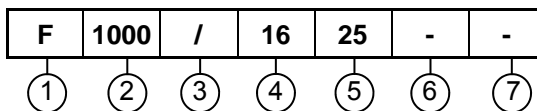

- ① - N = Phase Control Thyristors
- F = Fast Thyristors (inverter grade)
- D = Normal Recovery Diodes
- DF = Fast Recovery Diodes
- DD = Module (diode-diode)
- DT = Module (diode-thyristor)
- TD = Module (thyristor-diode)
- TT = Module (thyristor-thyristor)
- P = Press-fit diode
- ② - Average Current Code
- ③ - Essential Part Number
- ④ - Voltage Code x 100 = V_{RRM}
- ⑤ - Turn-off time (fast thyristors only)
- Reverse Recovery Time (fast diodes only)
- ⑥ - M = Metric Thread
- I = Inch Thread
- ⑦ - None = Anode to stud (stud diodes only)
- R = Cathode to stud (stud diodes only)

Inverter Grade Thyristors

Disclaimer

All product specifications and data are subject to change without notice.

Komkraft Ind.Com.de Componentes Eletrônicos Ltda., its affiliates, agents and employees, and all persons acting on its or their behalf (collectively, "Komkraft"), disclaim any and all liability for any errors, inaccuracies or incompleteness contained herein or in any other disclosure relating to any product.

Komkraft disclaims any and all liability arising of the use or application of any product described herein or of any information provided herein to the maximum extent permitted by law. The product specifications do not expand or otherwise modify Komkraft's terms and conditions of purchase, including but not limited to the warranty expressed therein, which apply to these products.

The products shown herein are not designed for use in medical, life-saving or life-sustaining applications unless otherwise expressly indicated.