

Features:

- Isolated mounting base 3000V~
- Pressure contact technology with
Increased power cycling capability
- Space and weight savings

Typical Applications

- AC/DC Motor drives
- Various rectifiers
- DC supply for PWM inverter

$I_{F(AV)}$	55A
V_{RRM}	1900~2500V
I_{FSM}	$1.3A \times 10^3$
I^2t	$8.45A^2 \cdot S \cdot 10^3$



SYMBOL	CHARACTERISTIC	TEST CONDITIONS	T _J (°C)	VALUE			UNIT
				Min	Type	Max	
$I_{F(AV)}$	Mean forward current	180° half sine wave 50Hz Single side cooled, T _C =100°C	150			55	A
$I_{F(RMS)}$	RMS forward current		150			86	A
V_{RRM}	Repetitive peak reverse voltage	V _{RRM} tp=10ms V _{RSM} = V _{RRM} +100V	150	1900		2500	V
I_{RRM}	Repetitive peak current	at V _{RRM}	150			8	mA
I_{FSM}	Surge forward current	10ms half sine wave	150			1.30	KA
I^2t	I ² T for fusing coordination	V _R =0.6V _{RRM}				8.45	A ² s*10 ³
V_{FO}	Threshold voltage		150			0.85	V
r_F	Forward slop resistance					3.76	mΩ
V_{FM}	Peak forward voltage	I _{FM} =170A	25			1.55	V
$R_{th(j-c)}$	Thermal resistance Junction to case	At 180° sine: Single side cooled				0.680	°C /W
$R_{th(c-h)}$	Thermal resistance case to heatsink	At 180° sine: Single side cooled				0.2	°C /W
V_{iso}	Isolation voltage	50Hz, R.M.S, t=1min, I _{iso} :1mA(max)		3000			V
F_m	Terminal connection torque(M5)				4		N·m
	Mounting torque(M6)				6		N·m
T_{stg}	Stored temperature			-40		125	°C
W_t	Weight				115		g
Outline	215F3/223F3						

Peak forward Voltage Vs. Peak forward Current

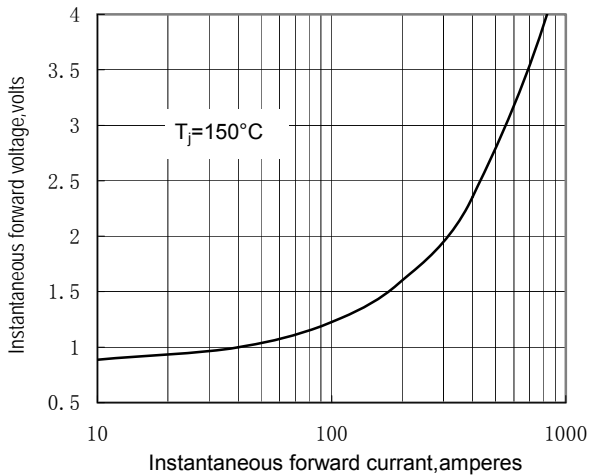

Fig.1

Max. junction To case Thermal Impedance Vs. Time

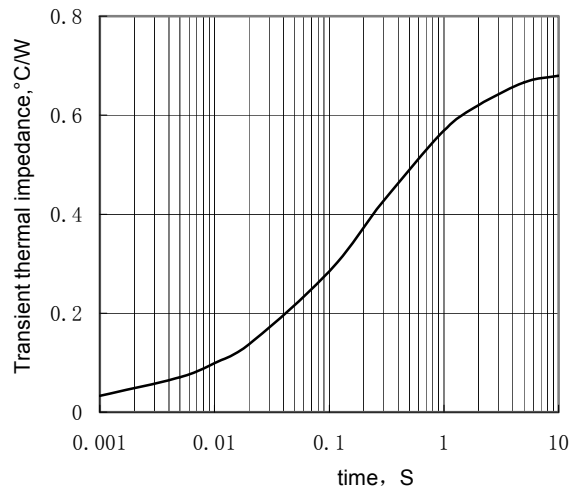

Fig.2

Max. Power Dissipation Vs. Mean forward Current

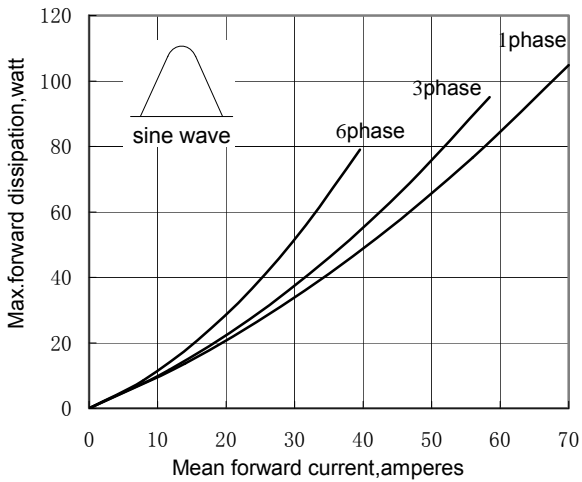

Fig.3

Max. case Temperature Vs. Mean forward Current

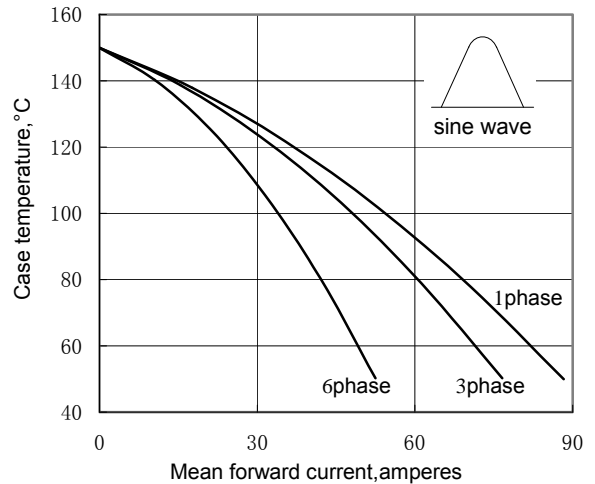

Fig.4

Max. Power Dissipation Vs. Mean forward Current

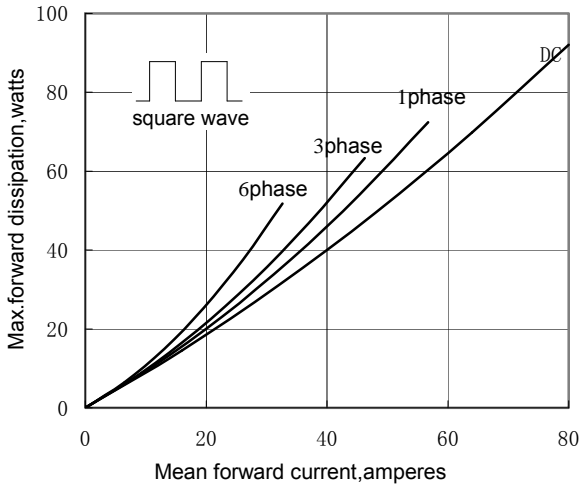

Fig.5

Max. case Temperature Vs. Mean forward Current

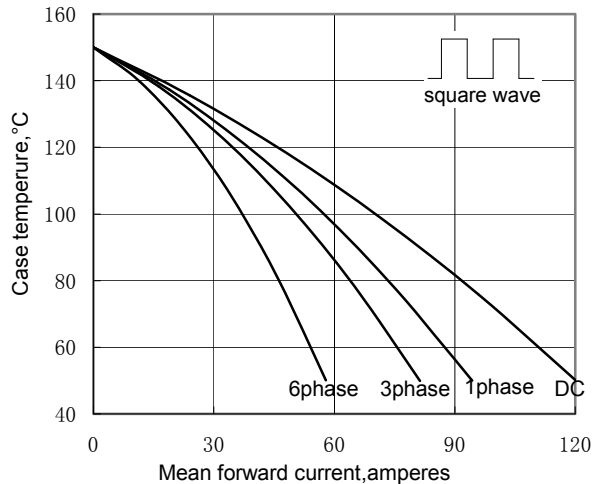

Fig.6

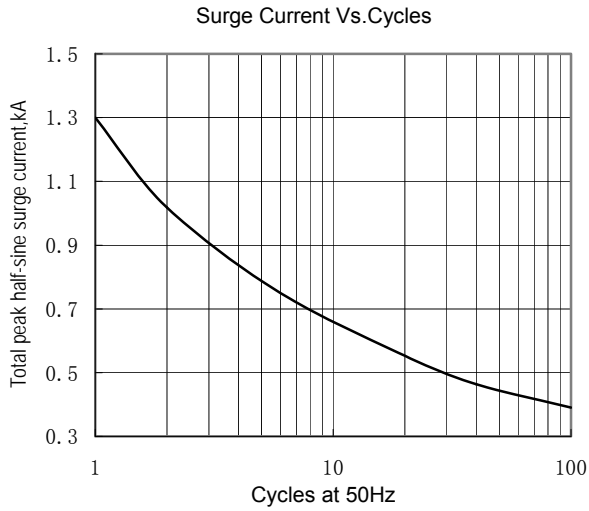

Fig.7

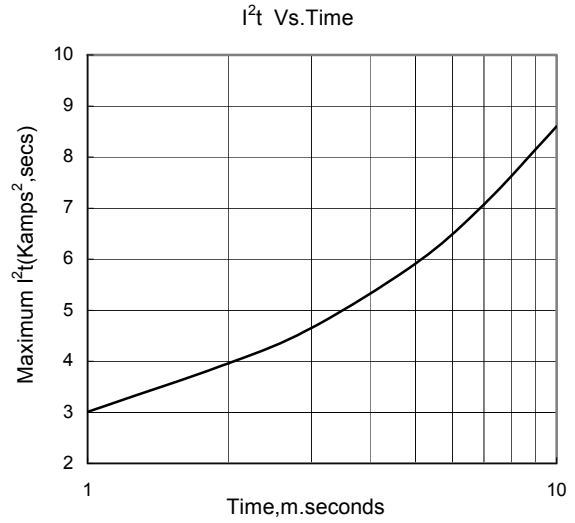
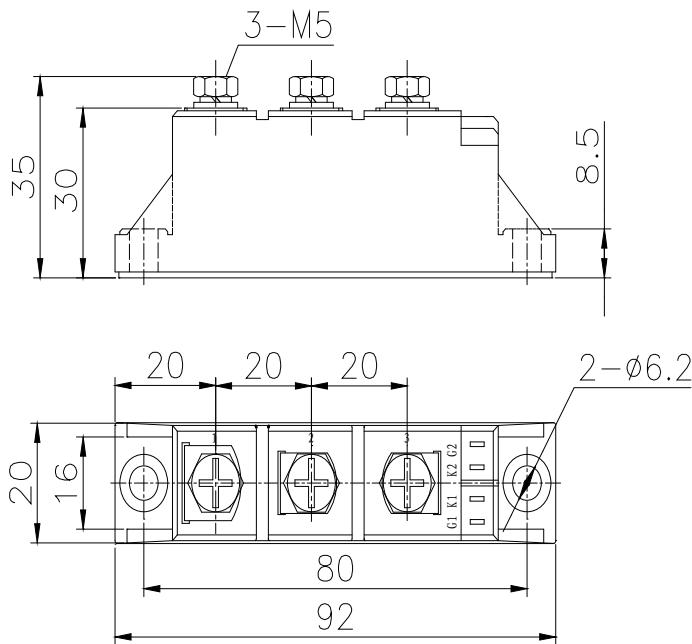

Fig.8

Outline:



215F3

