

Features:

- Isolated mounting base 3000V~
- Pressure contact technology with Increased power cycling capability
- Space and weight savings

Typical Applications

- AC/DC Motor drives
- Various rectifiers
- DC supply for PWM inverter

$I_{T(AV)}$ **55A**
 V_{DRM}/V_{RRM} **1900~2500V**
 I_{TSM} **1.50×10^3**
 I^2t **$11.3A^2 \cdot S \cdot 10^3$**



SYMBOL	CHARACTERISTIC	TEST CONDITIONS	T _J (°C)	VALUE			UNIT
				Min	Type	Max	
I _{T(AV)}	Mean on-state current	180° half sine wave 50Hz Single side cooled, T _c =85°C	125			55	A
I _{T(RMS)}	RMS on-state current		125			86	A
V _{DRM} V _{RRM}	Repetitive peak off-state voltage Repetitive peak reverse voltage	V _{DRM} &V _{RRM} tp=10ms V _{DISM} &V _{RSM} = V _{DRM} &V _{RRM} +100V respectively	125	1900		2500	V
I _{DRM} I _{RRM}	Repetitive peak current	at V _{DRM} at V _{RRM}	125			10	mA
I _{TSM}	Surge on-state current	10ms half sine wave	125			1.50	KA
I ² t	I ² T for fusing coordination	V _R =60%V _{RRM}					11.3
V _{TO}	Threshold voltage		125			0.85	V
r _T	On-state slop resistance						4.80
V _{TM}	Peak on-state voltage	I _{TM} =170A	25			1.96	V
dv/dt	Critical rate of rise of off-state voltage	V _{DM} =67%V _{DRM}	125			800	V/μs
di/dt	Critical rate of rise of on-state current	I _{TM} =110A, Gate source 1.5A t _r ≤0.5μs Repetitive	125			50	A/μs
I _{GT}	Gate trigger current	V _A =12V, I _A =1A	25	30		100	mA
V _{GT}	Gate trigger voltage			0.8		2.5	V
I _H	Holding current			20		150	mA
V _{GD}	Non-trigger gate voltage	V _{DM} =67%V _{DRM}	125	0.2			V
R _{th(j-c)}	Thermal resistance Junction to case	Single side cooled				0.49	°C/W
R _{th(c-h)}	Thermal resistance case to heat sink	Single side cooled				0.2	°C/W
V _{iso}	Isolation voltage	50Hz, R.M.S, t=1min, liso:1mA(MAX)		3000			V
F _m	Thermal connection torque (M5)				4.0		N·m
	Mounting torque (M6)				6.0		N·m
T _{stg}	Stored temperature			-40		125	°C
W _t	Weight				115		g
Outline	215F3/223F3						

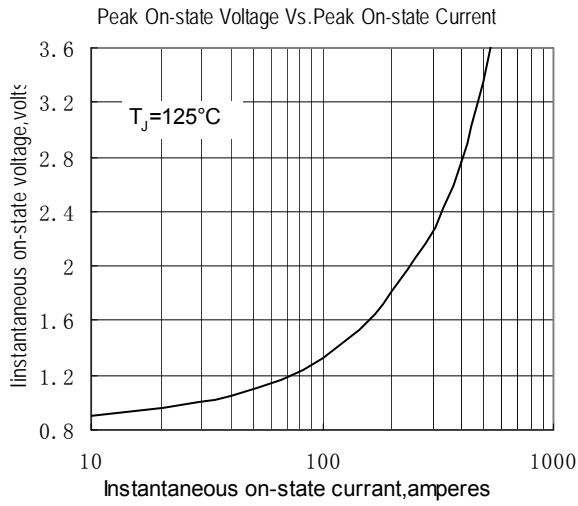

Fig.1

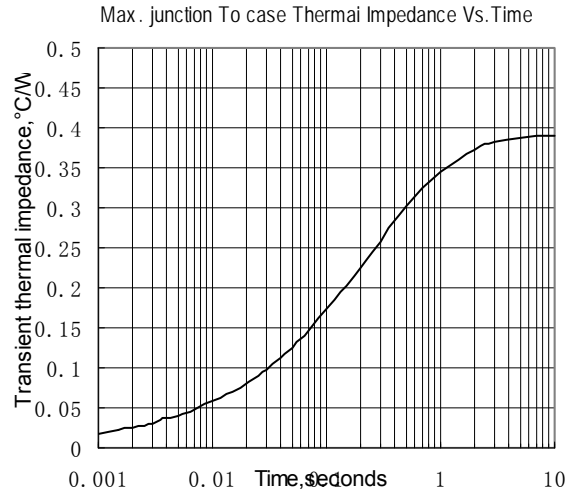

Fig.2

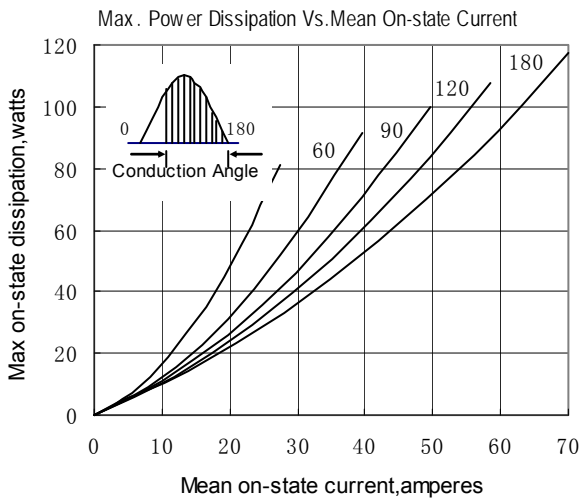

Fig.3

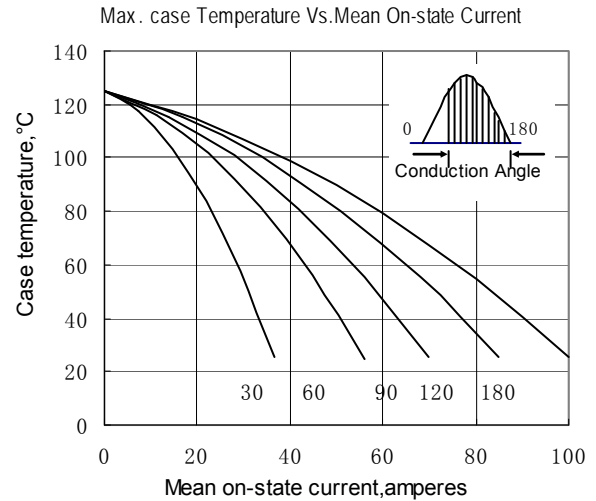

Fig.4

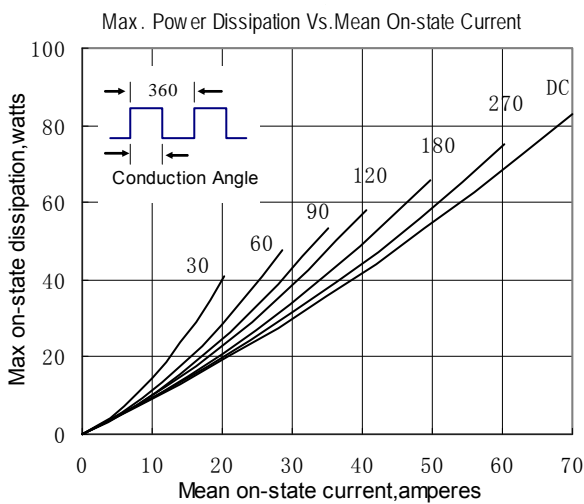

Fig.5

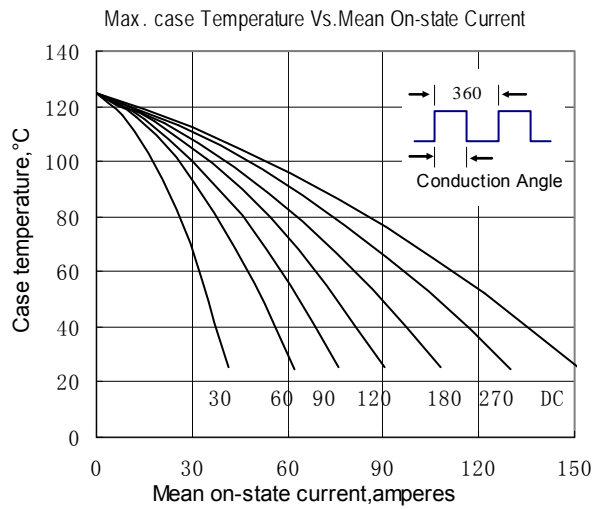

Fig.6

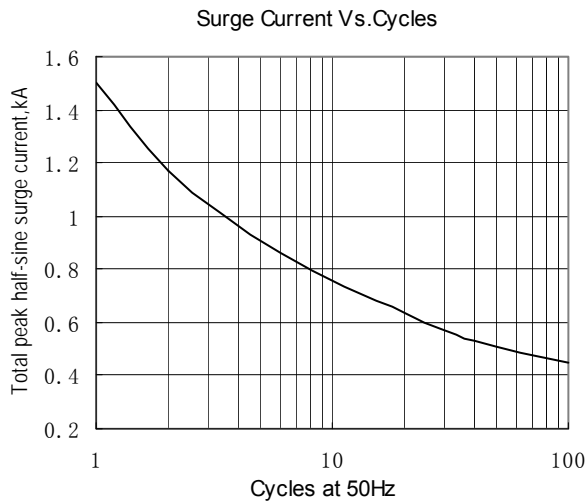

Fig.7

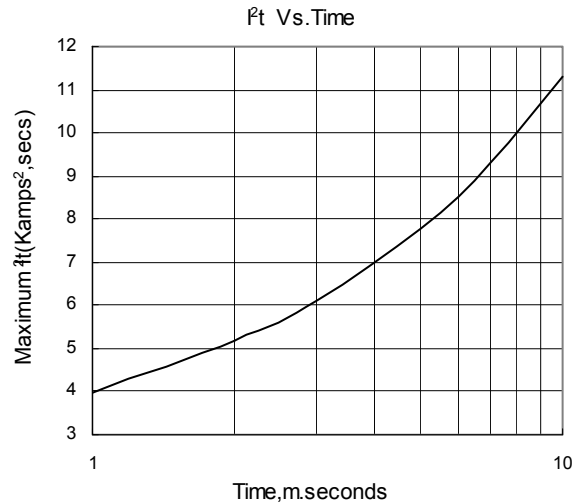

Fig.8

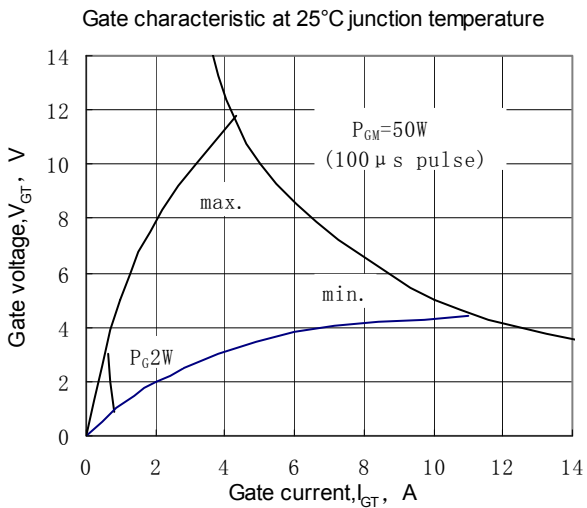

Fig.9

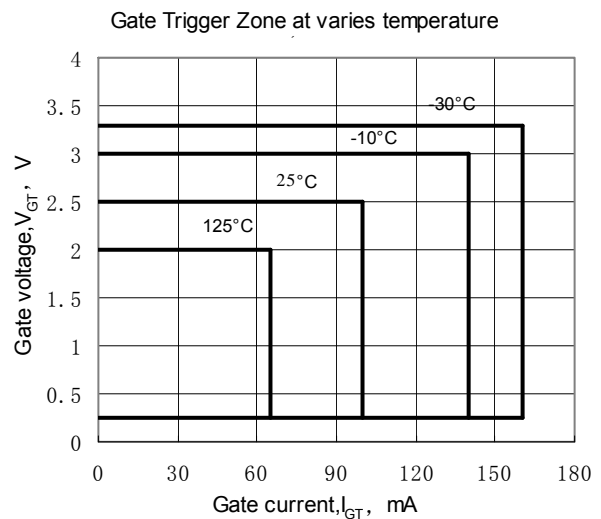
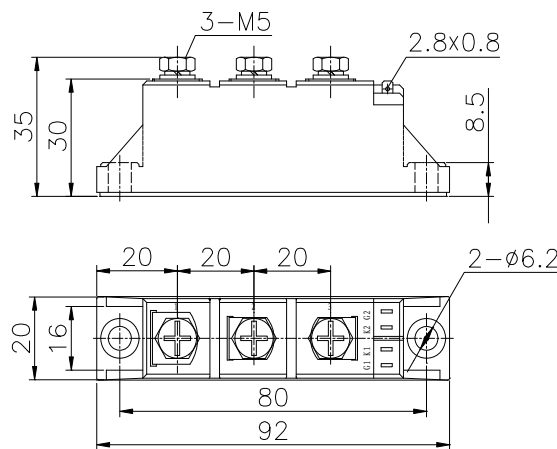

Fig.10

Outline:



215F3

