

MSD4N70

700V N-Channel MOSFET

Description

The MSD4N70 is a N-channel enhancement-mode MOSFET , providing the designer with the best combination of fast switching, ruggedized device design, low on-resistance and cost effectiveness. The TO-252 package is universally preferred for all commercial-industrial applications

Features

- Originative New Design
- 100% EAS Test
- Rugged Gate Oxide Technology
- Extremely Low Intrinsic Capacitances
- Remarkable Switching Characteristics
- Unequalled Gate Charge: 15 nC (Typ.)
- Extended Safe Operating Area
- Lower RDS(ON) : 2.5 Ω (Typ.) @VGS=10V
- RoHS compliant package

Application

- Low power battery chargers
- Switch mode power supply (SMPS)
- DC-AC converters.

Packing & Order Information

Part No./ T : 2,500/Tape&Reel

Part No./ R : 80/Tube , 4,000/Box

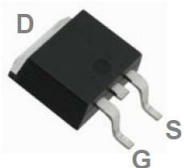

RoHS
COMPLIANT

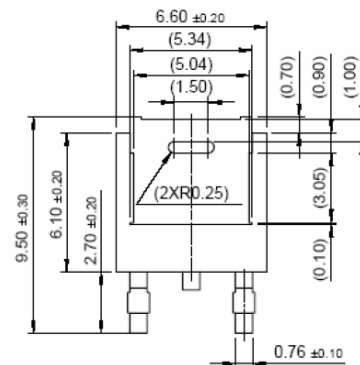
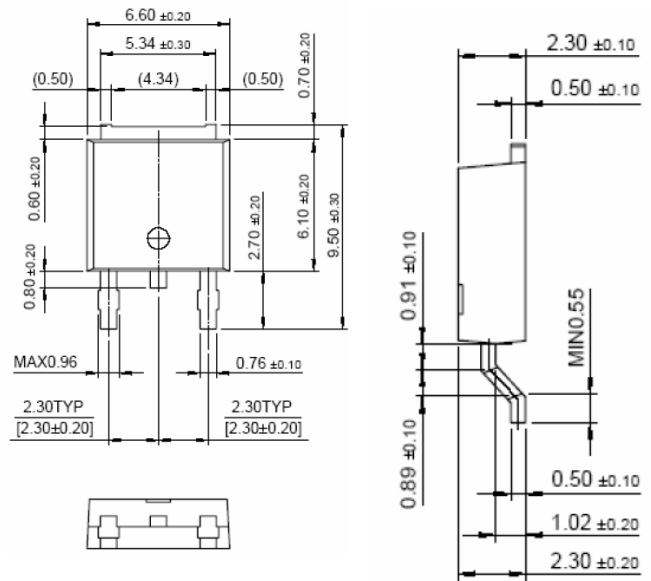

Graphic symbol

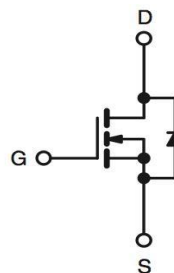

MAXIMUM RATINGS AND ELECTRICAL CHARACTERISTICS

Absolute Maximum Ratings (Tc=25°C unless otherwise noted)

Symbol	Parameter	Value	Unit
V _{DSS}	Drain-Source Voltage	700	V
V _{GS}	Gate-Source Voltage	±30	V
I _D	Continuous Drain Current (TC=25°C)	3.6	A
	Continuous Drain Current (T _C =100°C)	2.3	A

MSD4N70

700V N-Channel MOSFET

Absolute Maximum Ratings (Tc=25°C unless otherwise noted)

Symbol	Parameter	Value	Unit
I_{DM}	Pulsed Drain Current	14.4	A
EAS	Single Pulsed Avalanche Energy	240	mJ
EAR	Repetitive Avalanche Energy	4.4	mJ
dV/dt	Peak Diode Recovery dV/dt	5.5	V/ns
P_D	Power Dissipation (T _C =25°C)	55	W
	-Derate above 25C	0.4	W/°C
T _J , T _{STG}	Operating and Storage Temperature Range	-55 to + 150	°C
T _L	Maximum lead temperature for soldering purposes, 1/8" from case for 5 seconds	300	°C

- Drain current limited by maximum junction temperature

Thermal Resistance Characteristics

Symbol	Parameter	Typ.	Max.	Units
R _{θJC}	Junction-to-Case	--	2.5	°C/W
R _{θJA}	Junction-to- Ambient	--	110	

On Characteristics

Symbol	Parameter	Test Conditions	Min	Typ.	Max.	Units
V _{GS}	Gate Threshold Voltage	V _{DS} = V _{GS} , I _D = 250μA	2.0	--	4.0	V
R _{DS(ON)}	Static Drain-Source On-Resistance	V _{GS} = 10 V, I _D = 2.25 A	--	2.2	2.4	Ω

Off Characteristics

Symbol	Parameter	Test Conditions	Min	Typ.	Max.	Units
BV _{DSS}	Drain-Source Breakdown Voltage	V _{GS} = 0 V, I _D =250μA	700	--	--	V
ΔBV _{DSS} / ΔT _J	Breakdown Voltage Temperature Coefficient	I _D = 250μA, Referenced to 25°C	--	0.6	--	V/°C
I _{DSS}	Zero Gate Voltage Drain Current	V _{DS} = 700 V, V _{GS} = 0 V V _{DS} = 560 V, T _C = 125°C	--	--	1 10	μA
I _{GSSF}	Gate-Body Leakage Current, Forward	V _{GS} = 30 V, V _{DS} = 0 V	--	--	100	nA
I _{GSSR}	Gate-Body Leakage Current, Reverse	V _{GS} = -30 V, V _{DS} = 0 V	--	--	-100	nA

MSD4N70

700V N-Channel MOSFET

Dynamic Characteristics						
Symbol	Parameter	Test Conditions	Min	Typ.	Max.	Units
C_{ISS}	Input Capacitance	$V_{DS} = 25\text{ V}, V_{GS} = 0\text{ V},$ $F = 1.0\text{ MHz}$	--	550	730	pF
C_{OSS}	Output Capacitance		--	60	80	pF
C_{RSS}	Reverse Transfer Capacitance		--	8	11	pF
$t_{d(on)}$	Turn-On Time	$V_{DS} = 325\text{ V}, I_D = 3.6\text{ A},$ $R_G = 25\ \Omega$	--	10	20	ns
t_r	Turn-On Time		--	35	70	ns
$t_{d(off)}$	Turn-Off Delay Time		--	45	90	ns
t_f	Turn-Off Fall Time		--	40	80	ns
Q_g	Total Gate Charge	$V_{DS} = 520\text{ V}, I_D = 3.6\text{ A},$ $V_{GS} = 10\text{ V}$	--	15	20	nC
Q_{gs}	Gate-Source Charge		--	2.8	--	nC
Q_{gd}	Gate-Drain Charge		--	6.0	--	nC

Source-Drain Diode Maximum Ratings and Characteristics						
Symbol	Parameter	Test Conditions	Min	Typ.	Max.	Units
I_S	Continuous Source-Drain Diode Forward Current		--	--	3.6	A
I_{SM}	Pulsed Source-Drain Diode Forward Current		--	--	16	
V_{SD}	Source-Drain Diode Forward Voltage	$I_S = 4.0\text{ A}, V_{GS} = 0\text{ V}$	--	--	1.5	V
t_{rr}	Reverse Recovery Time	$I_S = 4.0\text{ A}, V_{GS} = 0\text{ V}$ $diF/dt = 100\text{ A}/\mu\text{s}$	--	300	--	ns
Q_{rr}	Reverse Recovery Charge		--	2.2	--	μC

Notes;

1. Repetitive Rating: Pulse width limited by maximum junction temperature
2. $I_{AS}=4\text{ A}, V_{DD}=50\text{ V}, R_G=25\text{ W},$ Starting $T_J=25^\circ\text{C}$
3. $I_{SD}\leq 4\text{ A}, di/dt\leq 300\text{ A}/\mu\text{s}, V_{DD}\leq BV_{DSS},$ Starting $T_J=25^\circ\text{C}$
4. Pulse Test: Pulse Width $\leq 300\mu\text{s},$ Duty Cycle $\leq 2\%$
5. Essentially Independent of Operating Temperature

MSD4N70

700V N-Channel MOSFET

Characteristics Curve

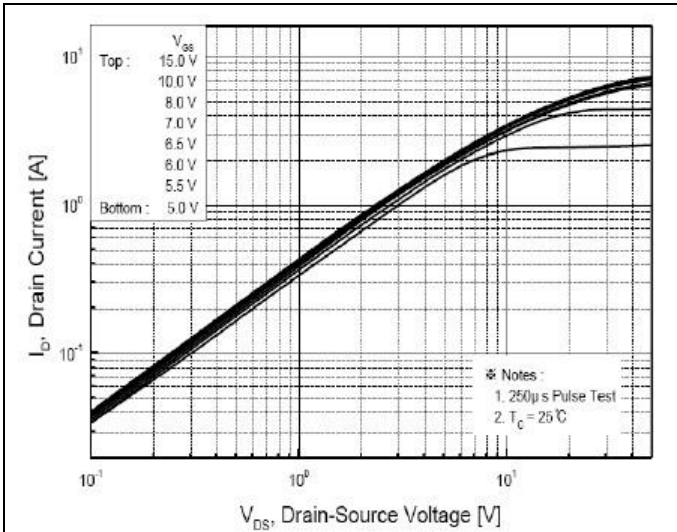

FIG.1-ON REGION CHARACTERISTICS

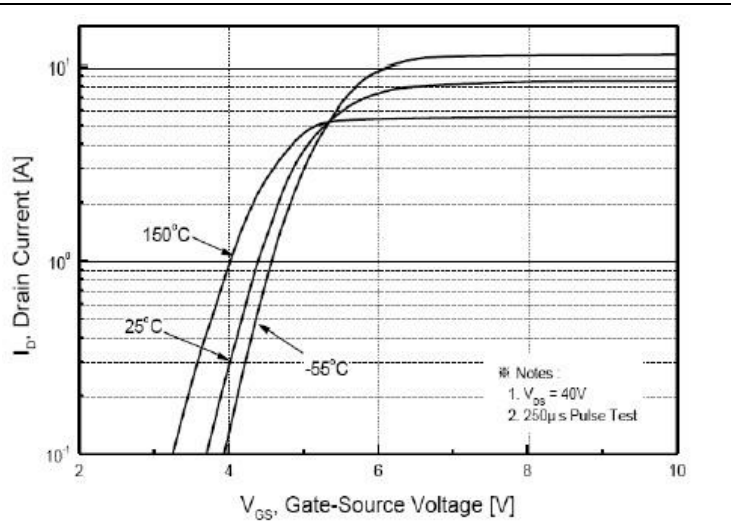

FIG.2-TRANSFER CHARACTERISTICS

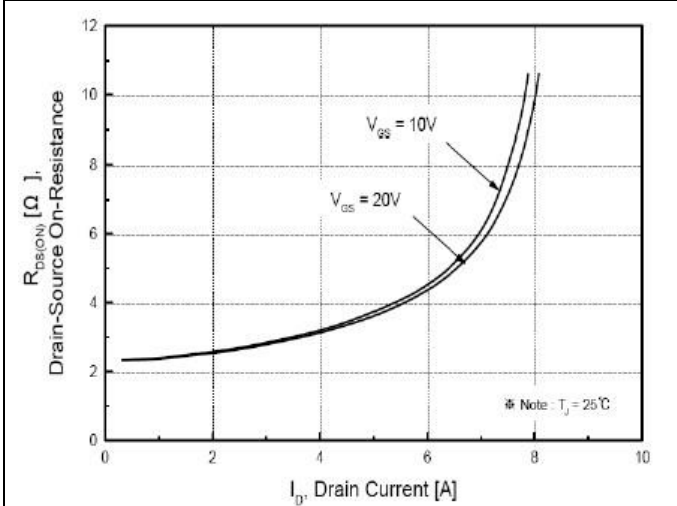

FIG.3-ON RESISTANCE VARIATION VS DRAIN CURRENT AND GATE VOLTAGE

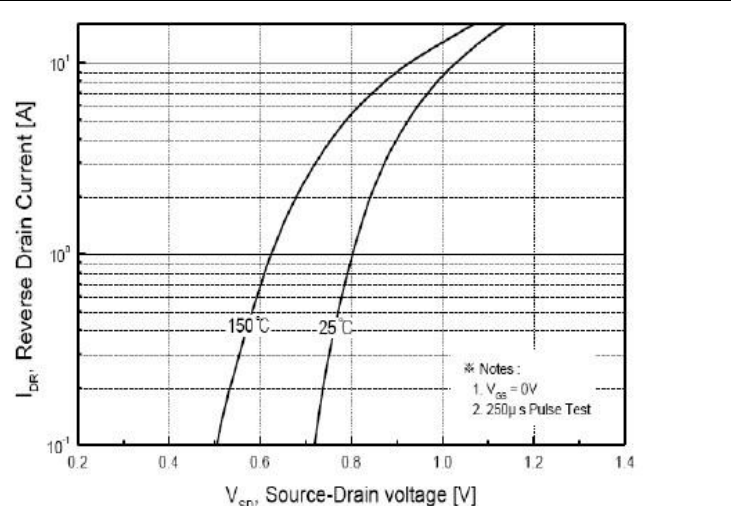

FIG.4-BODY DIODE FORWARD VOLTAGE VARIATION WITH SOURCE CURRENT AND TEMPERATURE

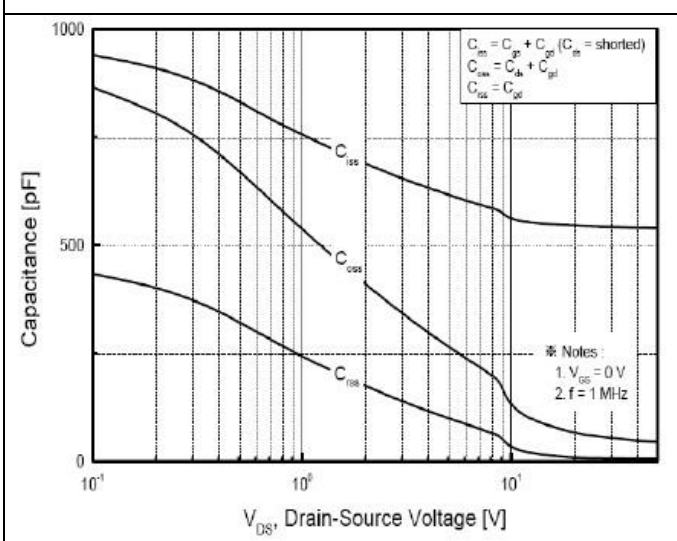

FIG.5-CAPACITANCE CHARACTERISTICS

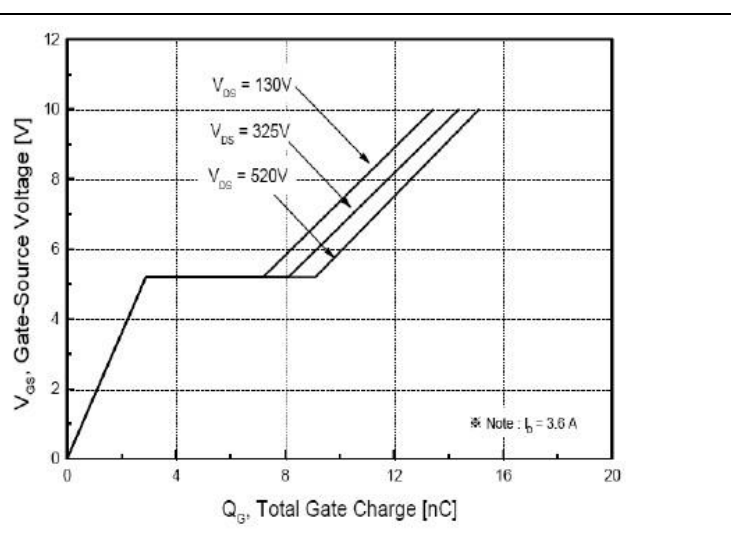

FIG.6-GATE CHARGE CHARACTERISTICS

MSD4N70

700V N-Channel MOSFET

Characteristics Curve

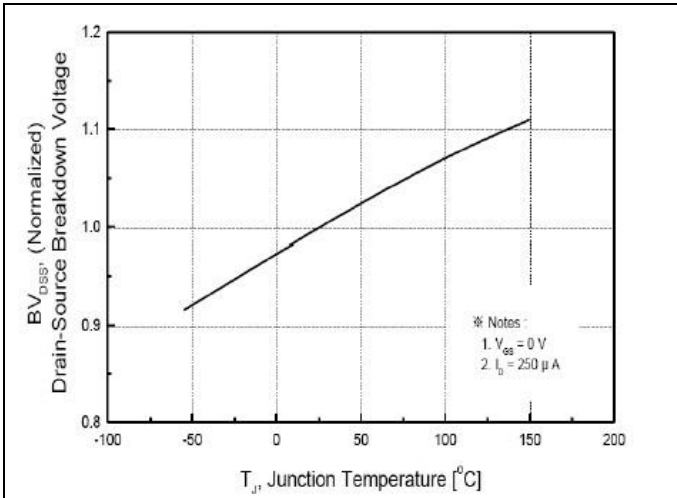

FIG.7-BREAKDOWN VOLTAGE VARIATION VS TEMPERATURE

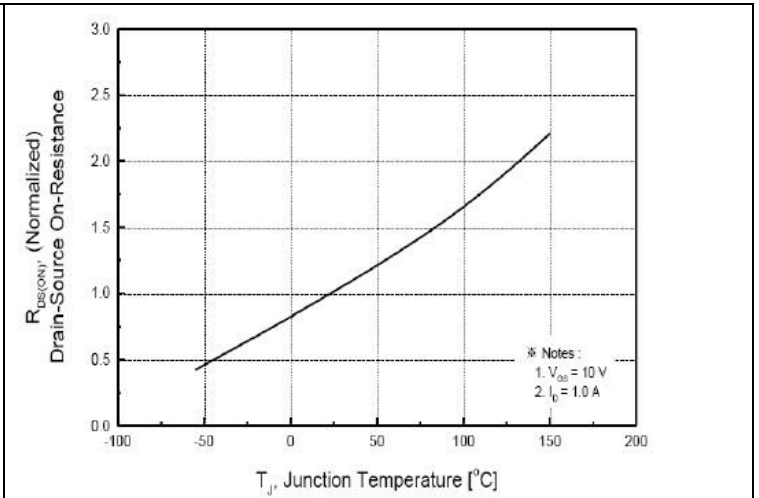

FIG.8-ON-RESISTANCE VARIATION VS TEMPERATURE

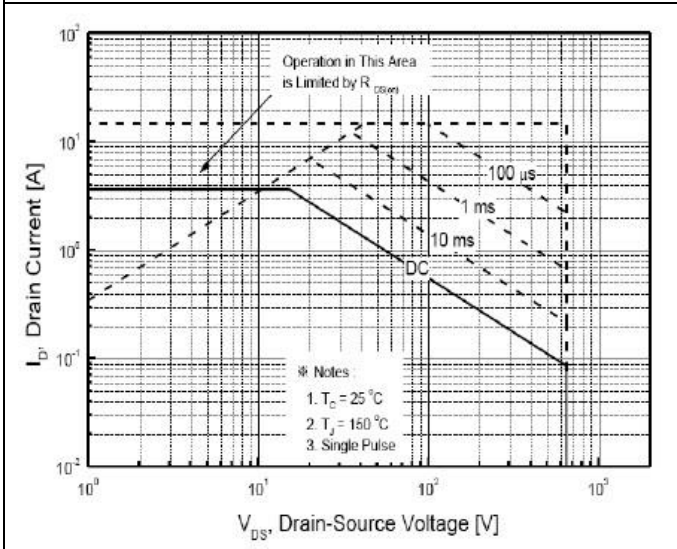

FIG.9-MAXIMUM SAFE OPERATING AREA

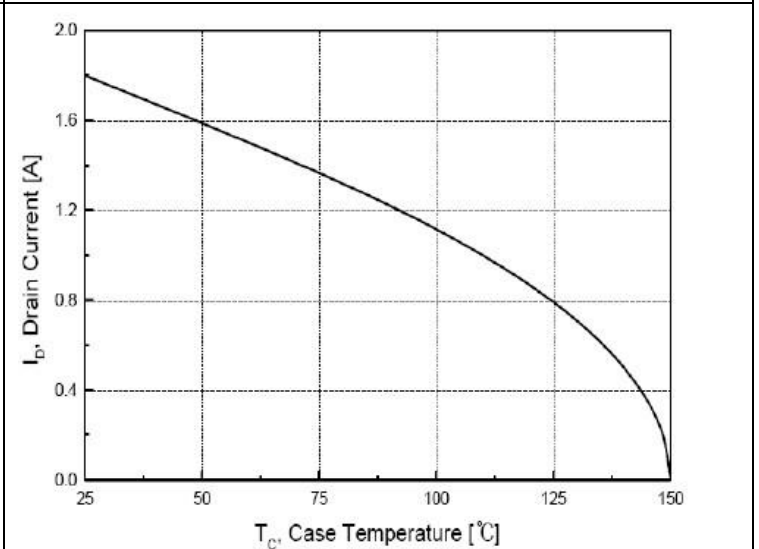

FIG.10-MAXIMUM DRAIN CURRENT VS CASE TEMPERATURE

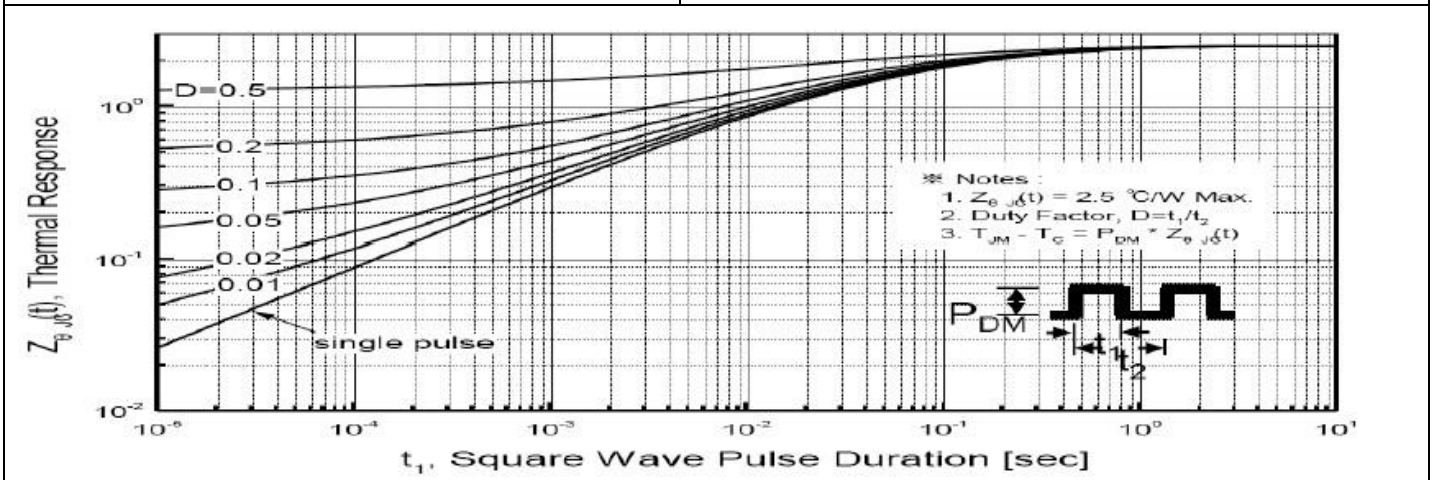

FIG.11-TRANSIENT THERMAL RESPONSE CURVE

MSD4N70

700V N-Channel MOSFET

Disclaimer

ALL PRODUCT, PRODUCT SPECIFICATIONS AND DATA ARE SUBJECT TO CHANGE WITHOUT NOTICE TO IMPROVE RELIABILITY, FUNCTION OR DESIGN OR OTHERWISE.

Bruckewell Technology Inc., its affiliates, agents, and employees, and all persons acting on its or their behalf (collectively, "Bruckewell"), disclaim any and all liability for any errors, inaccuracies or incompleteness contained in any datasheet or in any other disclosure relating to any product. Bruckewell makes no warranty, representation or guarantee regarding the suitability of the products for any particular purpose or the continuing production of any product. To the maximum extent permitted by applicable law, Bruckewell disclaims

- (i) Any and all liability arising out of the application or use of any product.
- (ii) Any and all liability, including without limitation special, consequential or incidental damages.
- (iii) Any and all implied warranties, including warranties of fitness for particular purpose, non-infringement and merchantability.

Statements regarding the suitability of products for certain types of applications are based on Bruckewell's knowledge of typical requirements that are often placed on Bruckewell products in generic applications.

Such statements are not binding statements about the suitability of products for a particular application. It is the customer's responsibility to validate that a particular product with the properties described in the product specification is suitable for use in a particular application. Parameters provided in datasheets and/or specifications may vary in different applications and performance may vary over time.

Product specifications do not expand or otherwise modify Bruckewell's terms and conditions of purchase, including but not limited to the warranty expressed therein.