

RS201-G Thru. RS207-G

Reverse Voltage: 50 to 1000V

Forward Current: 2.0Amperes

RoHS Device

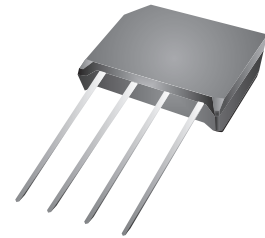

Features

- Surge overload rating -50 amperes peak.
- Ideal for printed circuit board.

Mechanical Data

- Epoxy: UL 94V-0 rate flame retardant.
- Case: Molded plastic, RS-2
- Mounting position: Any
- Weight: 2.85 grams.

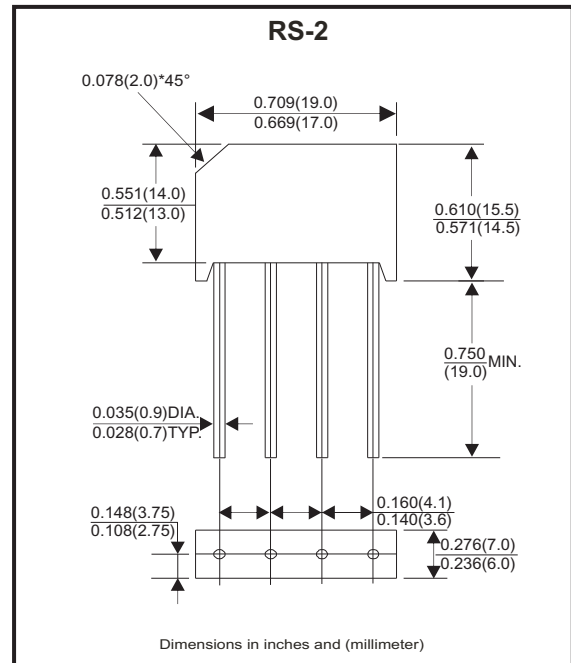

Maximum ratings and electrical characteristics

Rating at 25°C ambient temperature unless otherwise specified.
Single phase, half wave ,60Hz, resistive or inductive load.
For capacitive load, derate current by 20%

Parameter	Symbol	RS201-G	RS202-G	RS203-G	RS204-G	RS205-G	RS206-G	RS207-G	Unit
Maximum Recurrent Peak Reverse Voltage	V_{RRM}	50	100	200	400	600	800	1000	V
Maximum RMS Voltage	V_{RMS}	35	70	140	280	420	560	700	V
Maximum DC Blocking Voltage	V_{DC}	50	100	200	400	600	800	1000	V
Maximum Average Forward Rectified Current 0.375" (9.5mm) Lead Lengths @ $T_A = 40^\circ C$	I_{AV}	2.0							A
Peak Forward Surge Current , 8.3ms Single Half Sine-Wave Super Imposed On Rated Load (JEDEC Method)	I_{FSM}	50							A
Rating For Fusing ($t < 8.3$ ms)	I^2t	15							$A^2 s$
Maximum Forward Voltage Drop Per Element at 2.0A Peak	V_F	1.1							V
Maximum DC Reverse Current At Rated DC Blocking Voltage	I_R	10.0 1.0							μA mA
Typical Junction Capacitance Per Element (Note 1)	C_J	30							pF
Operating Temperature Range	T_J	-55 to +150							$^\circ C$
Storage Temperature Range	T_{STG}	-55 to +150							$^\circ C$

Note: 1.Measured at 1.0MHz and applied reverse voltage of 4.0V DC.

Company reserves the right to improve product design , functions and reliability without notice.

REV:A

Fig.1 - Derating Curve For Output Rectified Current

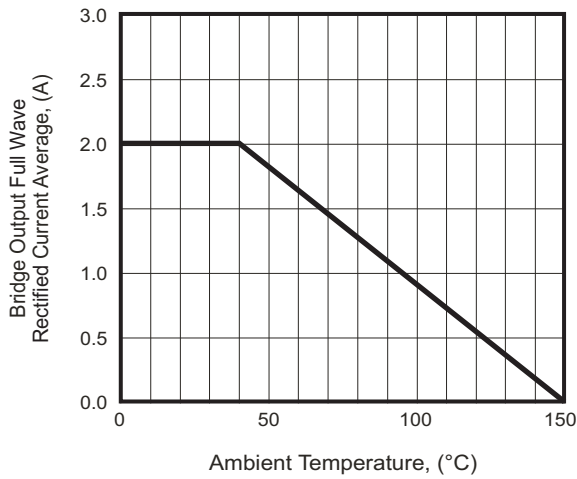

Fig.2 - Maximum Non-Repetitive Surge Current

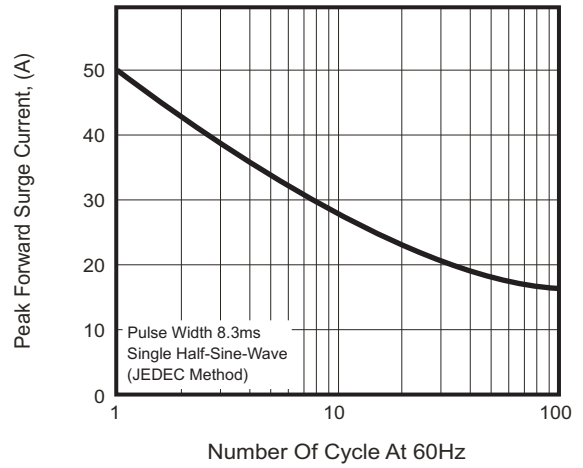

Fig.3 - Typical Forward Characteristics

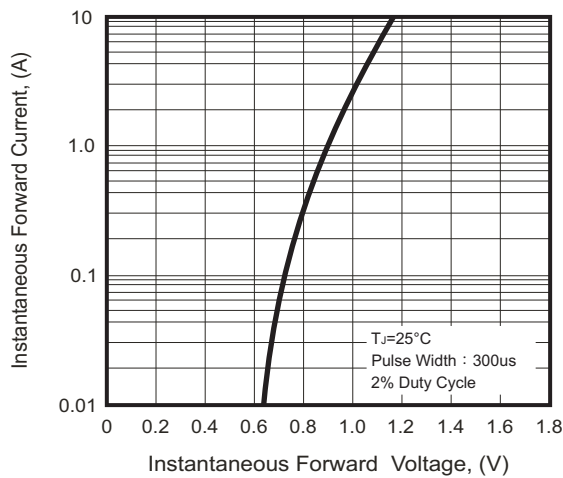

Fig.4 - Typical Reverse Characteristics

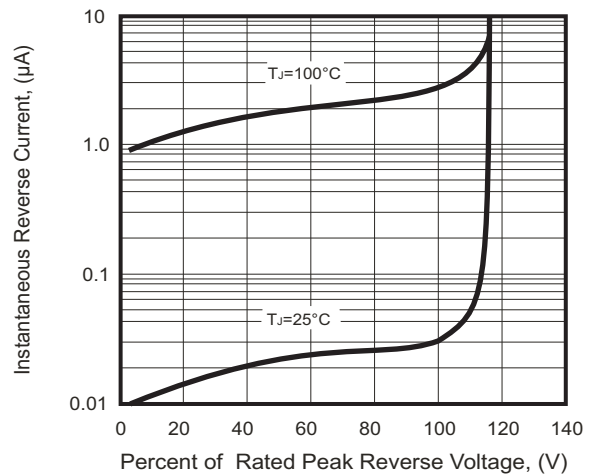
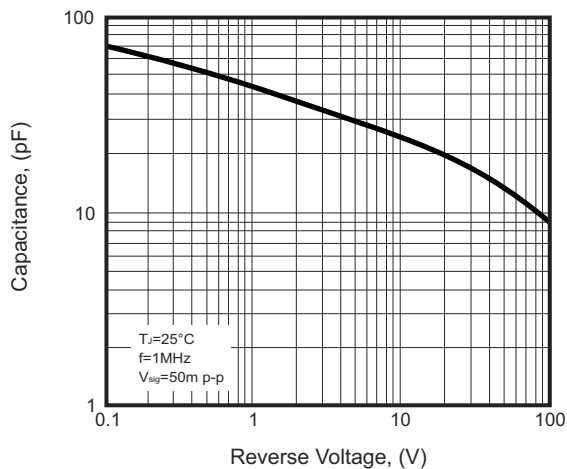
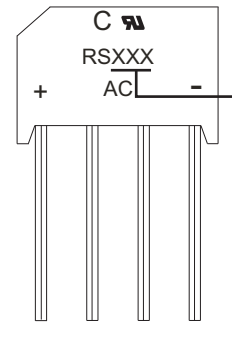

Fig.5 - Typical Junction Capacitance



Marking Code

Part Number	Marking code
RS201-G	RS201
RS202-G	RS202
RS203-G	RS203
RS204-G	RS204
RS205-G	RS205
RS206-G	RS206
RS207-G	RS207



XXX = Product type marking code
C = Comchip Logo

Standard Packaging

Case Type	BULK PACK	
	BOX (pcs)	CARTON (pcs)
RS-2	400	4,000