

## DF2005-G Thru. DF210-G

Reverse Voltage: 50 to 1000V

Forward Current: 2.0A

RoHS Device

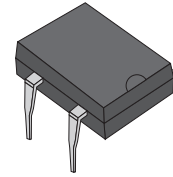

### Features

- Rating to 1000V PRV
- Ideal for printed circuit board
- Low forward voltage drop.
- High current capability.
- The plastic material has UL flammability classification 94V-0

### Mechanical Data

- Polarit: As marked on Body
- Weight: 0.38 grams
- Mounting position: Any

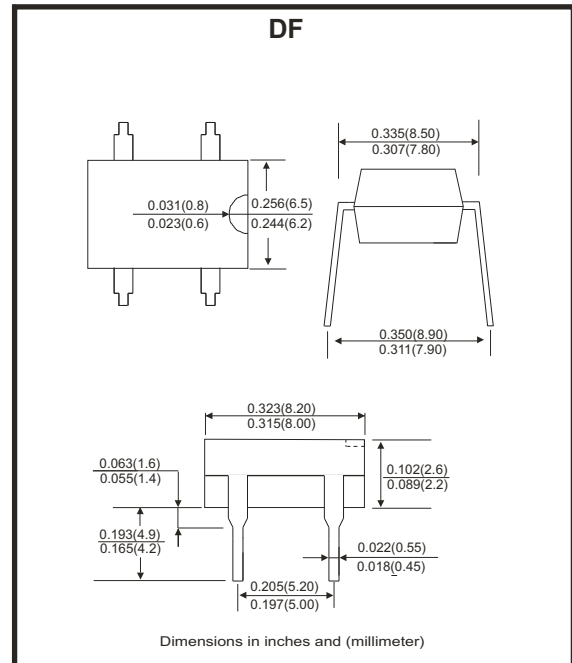

### Maximum ratings and electrical characteristics

Rating at 25°C ambient temperature unless otherwise specified.  
 Single phase, half wave ,60Hz, resistive or inductive load.  
 For capacitive load, derate current by 20%

Parameter	Symbol	DF2005-G	DF201-G	DF202-G	DF204-G	DF206-G	DF208-G	DF210-G	Unit
Maximum Recurrent Peak Reverse Voltage	$V_{RRM}$	50	100	200	400	600	800	1000	V
Maximum RMS Voltage	$V_{RMS}$	35	70	140	280	420	560	700	V
Maximum DC Blocking Voltage	$V_{DC}$	50	100	200	400	600	800	1000	V
Maximum Average Forward Rectified Current @ $T_A=40^\circ\text{C}$	$I_{(AV)}$	2.0							A
Peak Forward Surge Current , 8.3ms Single Half Sine-Wave Super Imposed on Rated Load	$I_{FSM}$	60							A
$I^2 t$ Rating for Fusing ( $t < 8.3\text{ms}$ )	$I^2 t$	10.4							$\text{A}^2\text{s}$
Maximum Forward Voltage at 2.0A DC	$V_F$	1.1							V
Maximum DC Reverse Current @ $T_J = 25^\circ\text{C}$ at Rated DC Blocking Voltage @ $T_J = 125^\circ\text{C}$	$I_R$	10 500							$\mu\text{A}$
Typical Junction Capacitance Per Element (Note 1)	$C_J$	25							pF
Typical Thermal Resistance (Note 2)	$R_{\theta JA}$	40							$^\circ\text{C}/\text{W}$
Operating Temperature Range	$T_J$	-55 ~ +150							$^\circ\text{C}$
Storage Temperature Range	$T_{STG}$	-55 ~ +150							$^\circ\text{C}$

Notes:

1. Measured at 1.0MHz and applied reverse voltage of 4.0V DC
2. Unit mounted on P.C.B with 0.50"×0.50" (13×13mm) copper pads.

Company reserves the right to improve product design , functions and reliability without notice.

REV: E

## Rating and Characteristics Curves (DF2005-G Thru. DF210-G)

FIG.1 - Derating Curve For Output Rectified Current

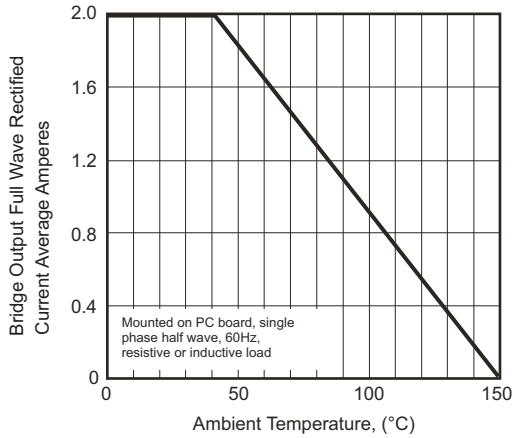

FIG. 2 - Maximum Non-Repetitive Peak Forward Surge Current

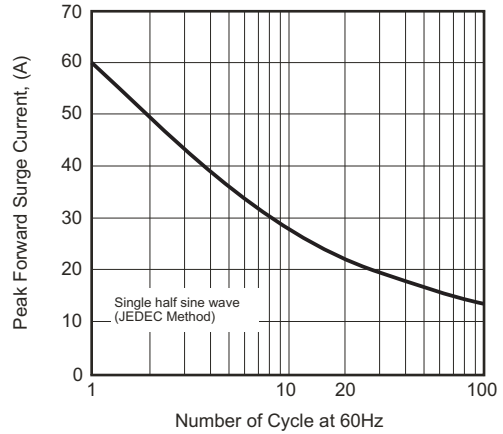

Fig.3 - Typical Junction Capacitance

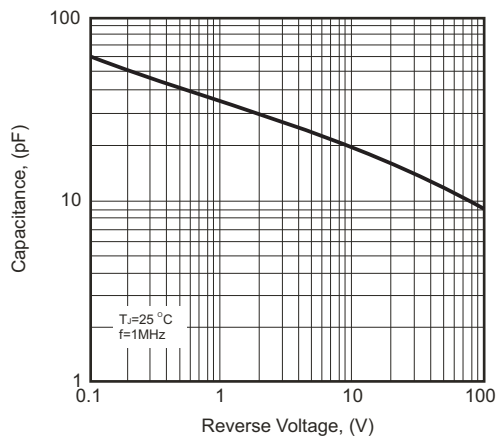

Fig.4 - Typical Forward Characteristics

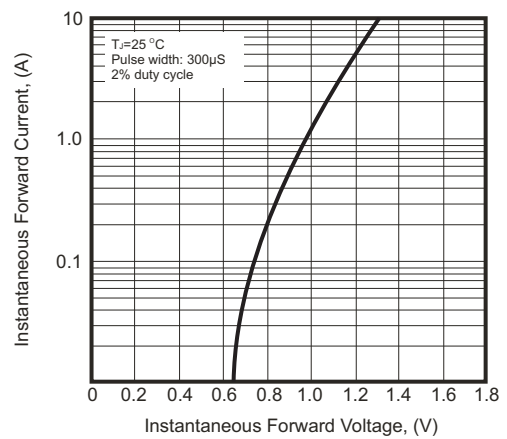
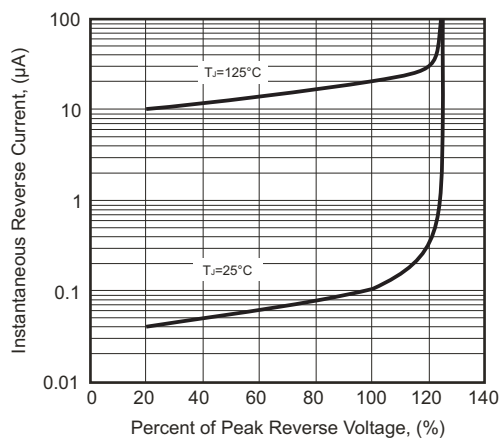
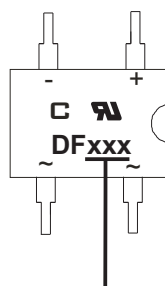

Fig.5 - Typical Reverse Characteristics



## Marking Code

Part Number	Marking code
DF2005-G	DF2005
DF201-G	DF201
DF202-G	DF202
DF204-G	DF204
DF206-G	DF206
DF208-G	DF208
DF210-G	DF210



XXXX / XXX = Product type marking code  
 C = Comchip Logo

## Standard Packaging

Case Type	TUBE PACK	
	TUBE ( pcs )	Carton ( pcs )
DF	50	5,000