

CGRHD101-G Thru. CGRHD107-G

Reverse Voltage: 50 to 1000 Volts

Forward Current: 1.0 A

RoHS Device

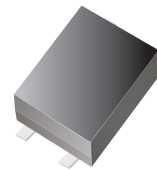

Features

- Surge overload ratings to 35 amperes peak.
- 1.0A rating in low profile surface mount min-dip bridge save space on printed circuit board.
- Ideal for automated replacement.
- Glass passivated chip junctions.
- UL recognized file # E321971

Mechanical data

- Epoxy: UL94-V0 rate flame retardant.
- Case: Molded plastic low profile SMD mini-dip(MDLS), Bridge case
- Terminals: solderable per MIL-STD-750,method 2026.
- Polarity: Marking on body.
- Mounting Position: Any
- weight: 0.10 grams (approx.).

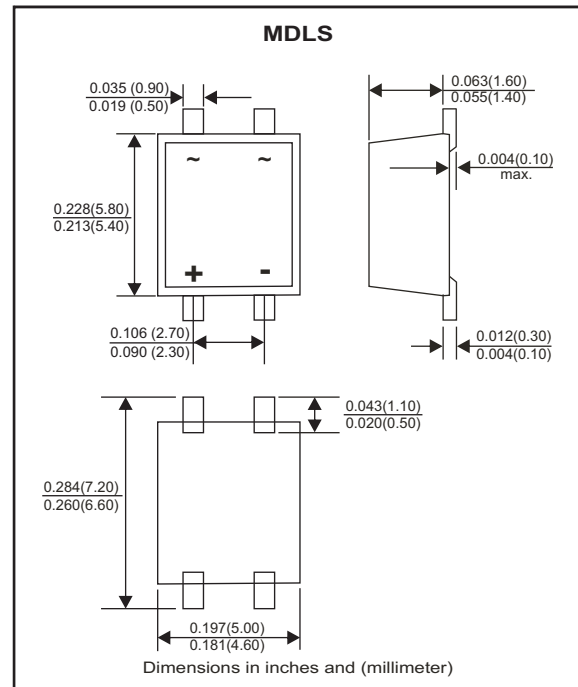

Maximum Rating And Electrical Characteristics

Rating at TA=25°C, unless otherwise noted.
Single phase, half wave, 60Hz, resistive or inductive load.
For capacitive load, derate current by 20%.

Parameter	Symbol	CGRHD 101-G	CGRHD 102-G	CGRHD 103-G	CGRHD 104-G	CGRHD 105-G	CGRHD 106-G	CGRHD 107-G	Unit
Maximum Repetitive Peak Reverse Voltage	V _{RRM}	50	100	200	400	600	800	1000	V
Maximum RMS Voltage	V _{RMS}	35	70	140	280	420	560	700	V
Maximum Continuous Reverse Voltage	V _R	50	100	200	400	600	800	1000	V
Maximum Forward Rectified Current	I _(AV)	1.0							A
Peak Forward Surge Current 8.3mS single half sine-wave, superimposed on rate load(JEDEC Method)	I _{FSM}	35							A
Maximum Forward Voltage	at I _F =0.5A	1.0							V
	at I _F =1.0A	1.1							
Maximum Reverse Current	@V _R =V _{RRM} T _J =25°C	5.0							μA
	@V _R =V _{RRM} T _J =100°C	150							
Typical Thermal Resistance	Junction to ambient,note 1	62.5							°C/W
	Junction to lead	25.0							
Typical Junction Capacitance (Per leg, note 2)	C _J	25							pF
Operating Temperature Range	T _J	-55 to +150							°C
Storage Temperature Range	T _{STG}	-65 to +175							°C

Notes: 1. Thermal resistance from Junction to Ambient and from junctionto lead mounted on glass epoxy P.C.B 0.8*0.8(20*20mm) copper pad.
2. Measure at 1.0 MHz and applied reverse voltage of 4.0 volts.

RATING AND CHARACTERISTIC CURVES (CGRHD101-G thru CGRHD107-G)

Fig.1 - Forward Current Derating Curve

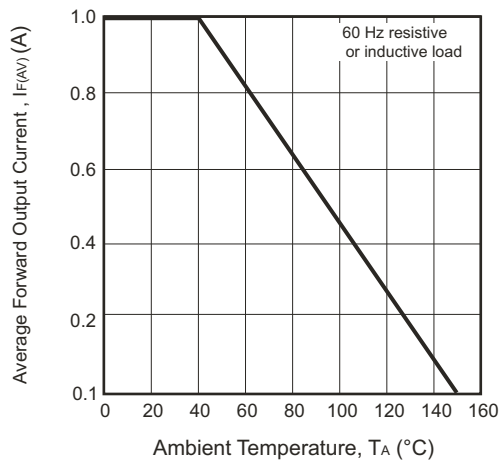

Fig.2 - Maximum Non-Repetitive Peak Forward Surge Current

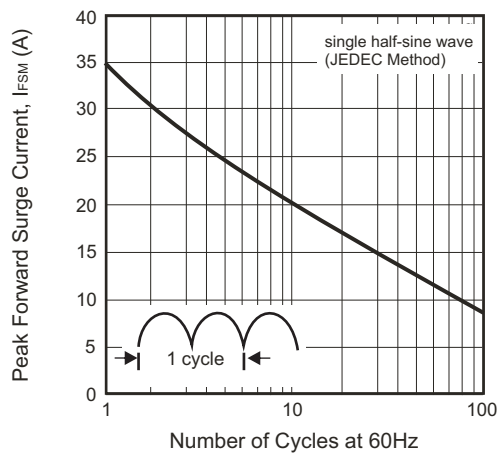

Fig.3 - Typical Instantaneous Forward Characteristics (Per Leg)

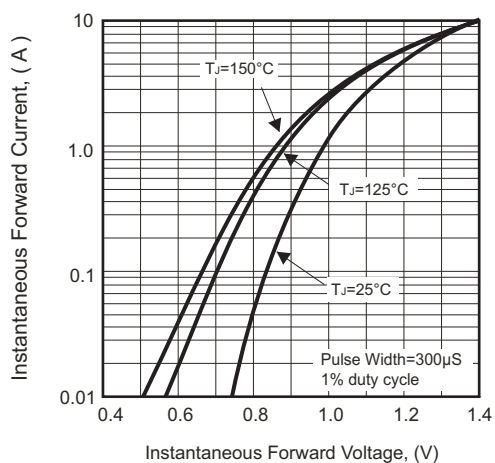

Fig.4 - Typical Reverse Characteristics (Per Leg)

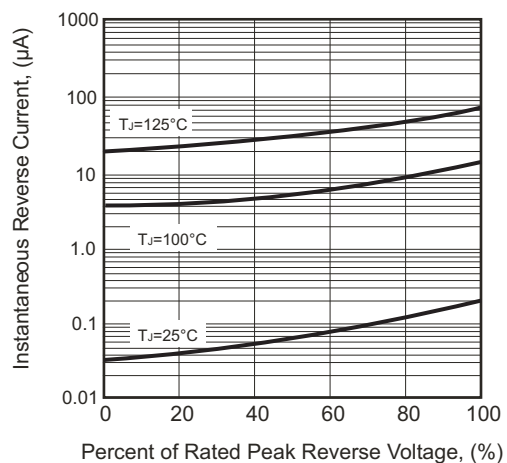
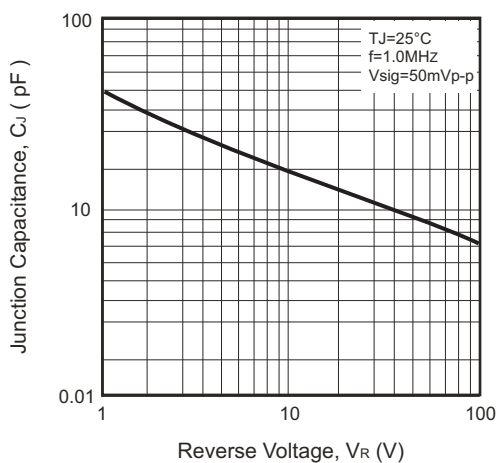
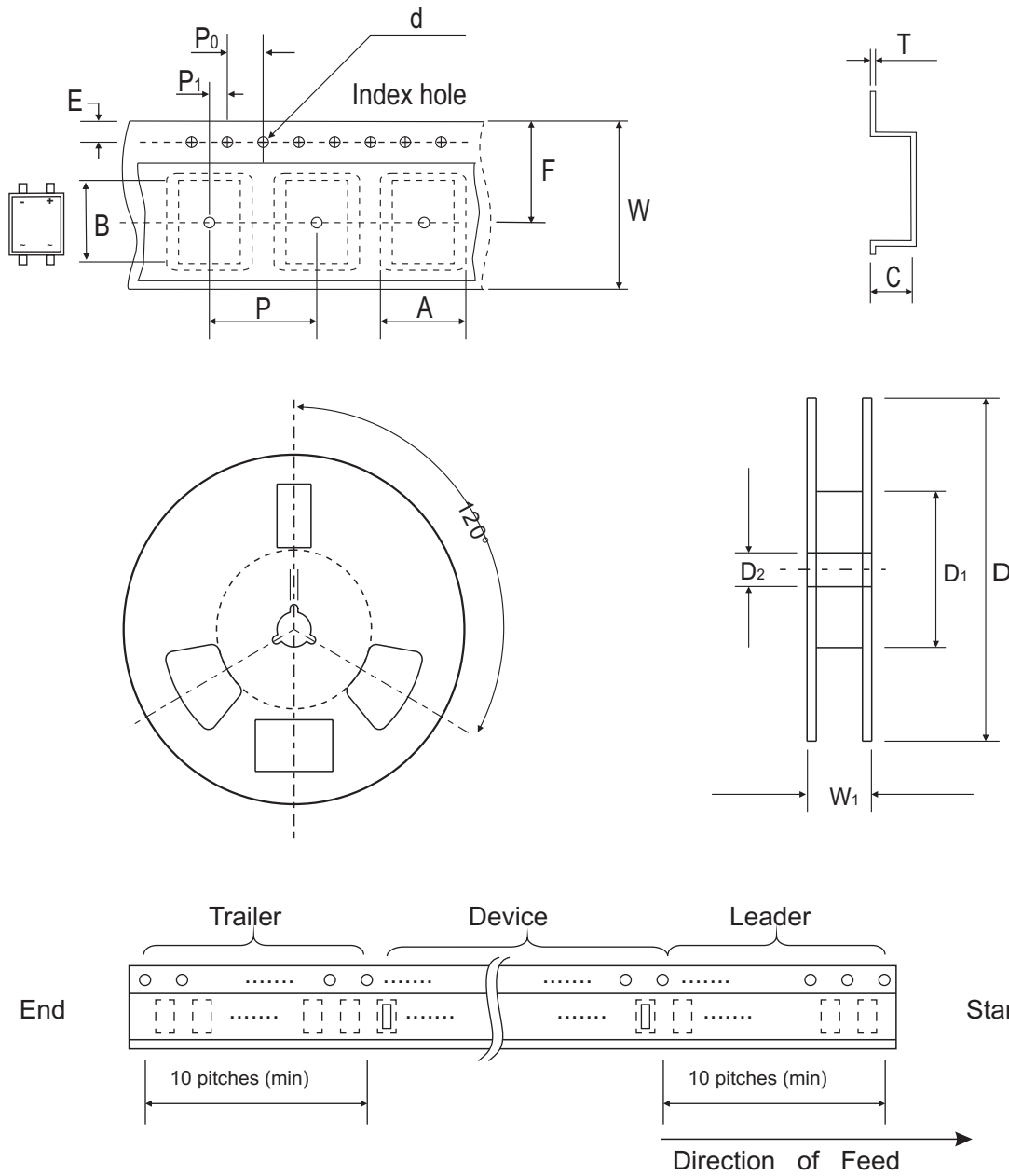

Fig.5 - Typical Junction Capacitance (Per Leg)



Reel Taping Specification



MDLS	SYMBOL	A	B	C	d	D	D1	D2
	(mm)	5.05 ± 0.10	7.01 ± 0.10	1.70 ± 0.10	1.50 ± 0.05	330 ± 1.50	75.00 ± 1.00	13.50 ± 0.50
	(inch)	0.199 ± 0.004	0.276 ± 0.004	0.067 ± 0.004	0.059 ± 0.002	12.99 ± 0.059	2.95 ± 0.039	0.531 ± 0.020

MDLS	SYMBOL	E	F	P	P_0	P_1	W	W_1
	(mm)	1.75 ± 0.10	5.50 ± 0.05	8.00 ± 0.10	4.00 ± 0.10	2.00 ± 0.25	12.0 ± 0.15	13.5 ± 0.50
	(inch)	0.069 ± 0.004	0.217 ± 0.002	0.315 ± 0.004	0.157 ± 0.004	0.079 ± 0.010	0.472 ± 0.006	0.531 ± 0.020

Pinning information

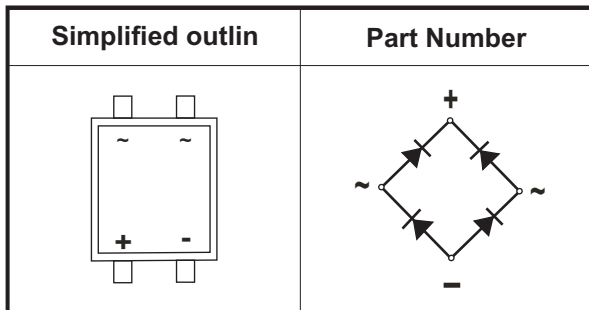

Marking Code

Part Number	Marking code
CGRHD101-G	MBLS1A
CGRHD102-G	MBLS1B
CGRHD103-G	MBLS1D
CGRHD104-G	MBLS1G
CGRHD105-G	MBLS1J
CGRHD106-G	MBLS1K
CGRHD107-G	MBLS1M

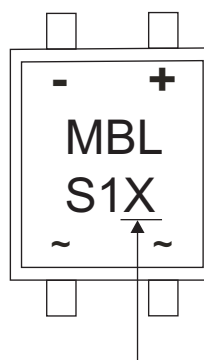

X = Product type marking code

Suggested PAD Layout

SIZE	MDLS	
	(mm)	(inch)
A	1.50	0.059
B	1.20	0.047
C	1.20	0.047
D	5.40	0.213

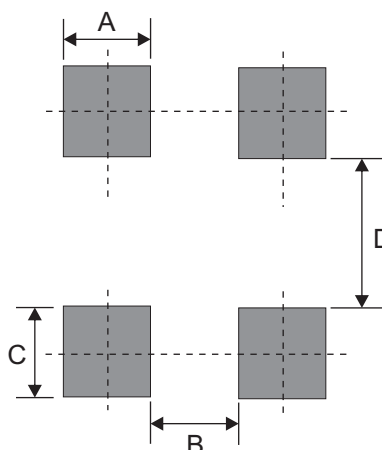

Standard Packaging

Case Type	Reel	
	Qty Per Reel	Reel Size
	(Pcs)	(inch)
MDLS	5,000	13