

## BC846A-G Thru. BC848C-G (NPN)

### RoHS Device



### Features

- Power dissipation  
PCM: 0.20W (@TA=25 °C)
- Collector current  
ICM: 0.1A
- Collector-base voltage  
VCBO: BC846=80V  
BC847=50V  
BC848=30V
- Operating and storage junction temperature range: TJ, TSTG= -65 to +150 °C

### Mechanical data

- Case: SOT-23, molded plastic.
- Terminals: solderable per MIL-STD-750, method 2026.
- Approx. weight: 0.008 grams

### Circuit diagram

- 1.BASE
- 2.EMITTER
- 3.COLLECTOR

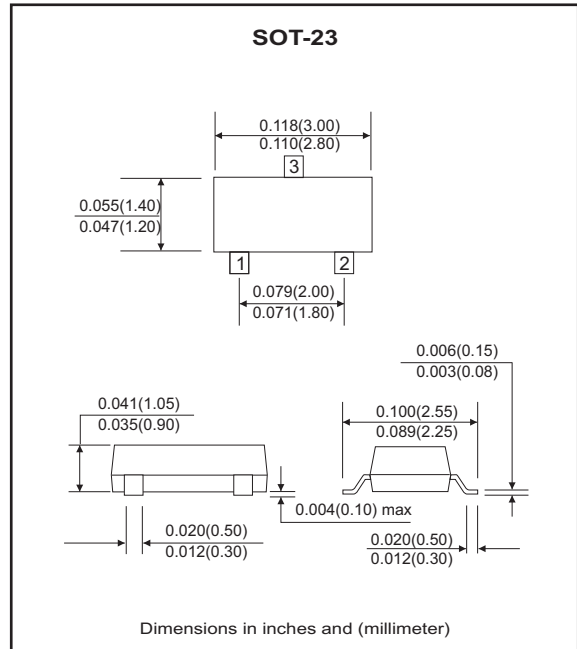
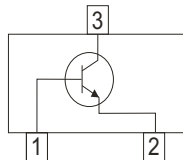

### Maximum Ratings (at Ta=25 °C unless otherwise noted)

Parameter	Symbol	Value	UNIT
Collector-Base Voltage	BC846-G	80	V
	BC847-G	50	
	BC848-G	30	
Collector-Emitter Voltage	BC846-G	65	V
	BC847-G	45	
	BC848-G	30	
Emitter-Base Voltage	VEBO	6	V
Collector Current -Continuous	IC	0.1	A
Collector Power Dissipation	PC	200	mW
Junction Temperature	TJ	150	°C
Storage Temperature Range	TSTG	-65 to +150	°C

## Electrical Characteristics

(BC846A-G Thru. BC848C-G, @T<sub>A</sub> = 25 °C unless otherwise specified)

Parameter	Symbol	Test Conditions	MIN	TYP	MAX	UNIT
Collector-Base Breakdown Voltage	BC846-G BC847-G BC848-G V <sub>CB0</sub>	I <sub>c</sub> = 10μA , I <sub>E</sub> = 0	80 50 30			V
Collector-Emitter Breakdown Voltage	BC846-G BC847-G BC848-G V <sub>CEO</sub>	I <sub>c</sub> = 10mA , I <sub>B</sub> = 0	65 45 30			V
Emitter-Base Break Voltage	V <sub>EBO</sub>	I <sub>E</sub> = 10μA , I <sub>C</sub> = 0	6			V
Collector Cut-off Current	BC846-G BC847-G BC848-G I <sub>CBO</sub>	V <sub>CB</sub> = 70V , I <sub>E</sub> = 0 V <sub>CB</sub> = 50V , I <sub>E</sub> = 0 V <sub>CB</sub> = 30V , I <sub>E</sub> = 0			0.1	μA
Collector Cut-off Current	BC846-G BC847-G BC848-G I <sub>CEO</sub>	V <sub>CB</sub> = 60V , I <sub>E</sub> = 0 V <sub>CB</sub> = 45V , I <sub>E</sub> = 0 V <sub>CB</sub> = 30V , I <sub>E</sub> = 0			0.1	μA
Emitter cut-off current	I <sub>EBO</sub>	V <sub>EB</sub> = 5V , I <sub>C</sub> = 0			0.1	μA
DC Current Gain	BC846A,BC847A,BC848A BC846B,BC847B,BC848B BC847C,BC848C h <sub>FE</sub>	V <sub>CE</sub> = 5V , I <sub>C</sub> = 2mA	110 200 420		220 450 800	
Collector-Emitter Saturation Voltage	V <sub>CE(sat)</sub>	I <sub>C</sub> = 100mA , I <sub>B</sub> = 5mA			0.5	V
Base-Emitter Saturation Voltage	V <sub>BE(sat)</sub>	I <sub>C</sub> = 100mA , I <sub>B</sub> = 5mA			1.1	V
Transition Frequency	f <sub>T</sub>	V <sub>CE</sub> = 5V , I <sub>C</sub> = 10mA f = 100MHz	100			MHz
Collector Output Capacitance	C <sub>ob</sub>	V <sub>CB</sub> = 10V , f = 1MHz			4.5	pF

## Electrical Characteristic Curves (BC846A-G Thru. BC848C-G)

**Fig.1- Static Characteristic**

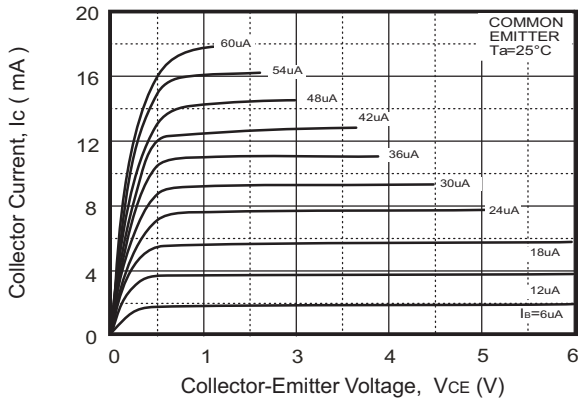

**Fig.2-  $h_{FE} - I_c$**

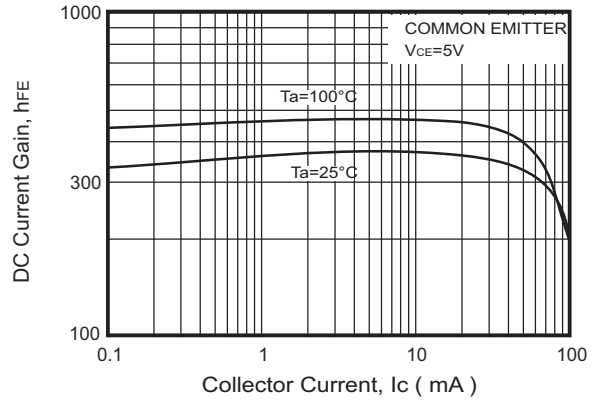

**Fig.3-  $V_{CEsat} - I_c$**

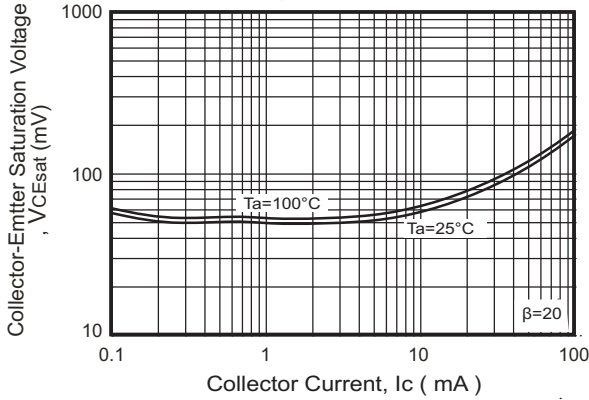

**Fig.4-  $V_{BEsat} - I_c$**

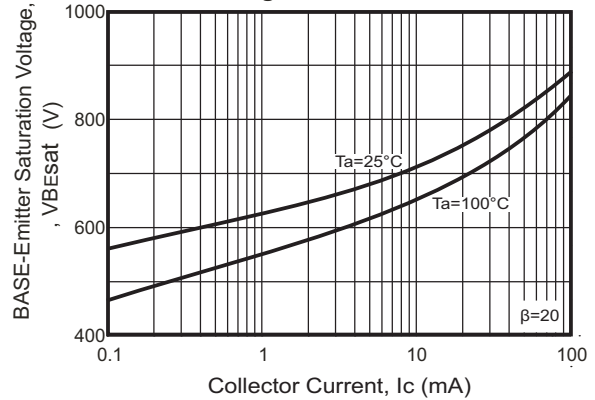

**Fig.5-  $I_c - V_{BE}$**

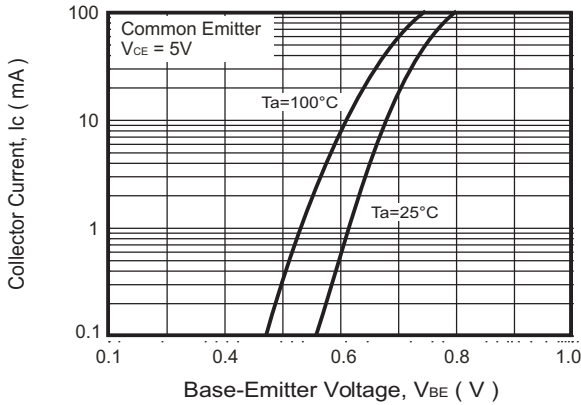

**Fig.6-  $C_{ob}/C_{ib} - V_{CB}/V_{EB}$**

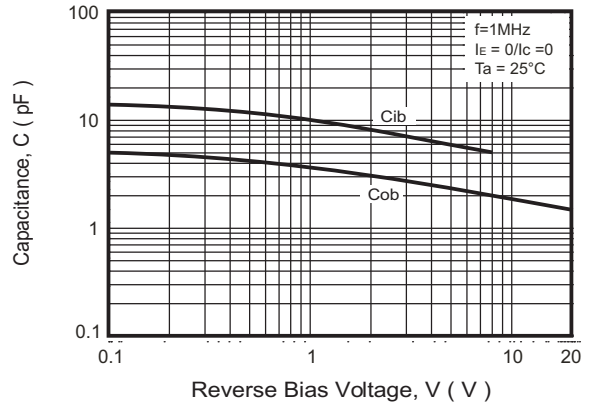

**Fig.7-  $f_r - I_c$**

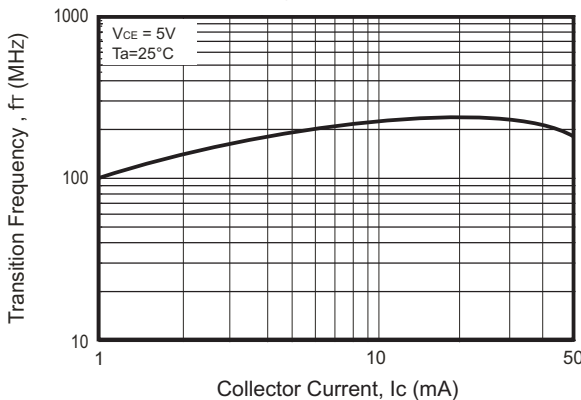

**Fig.8-  $P_c - T_a$**

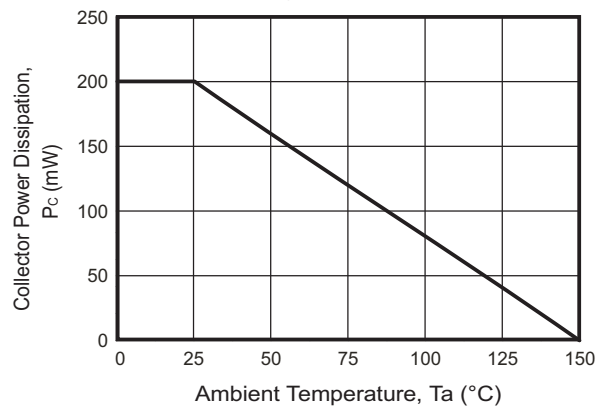

## Reel Taping Specification

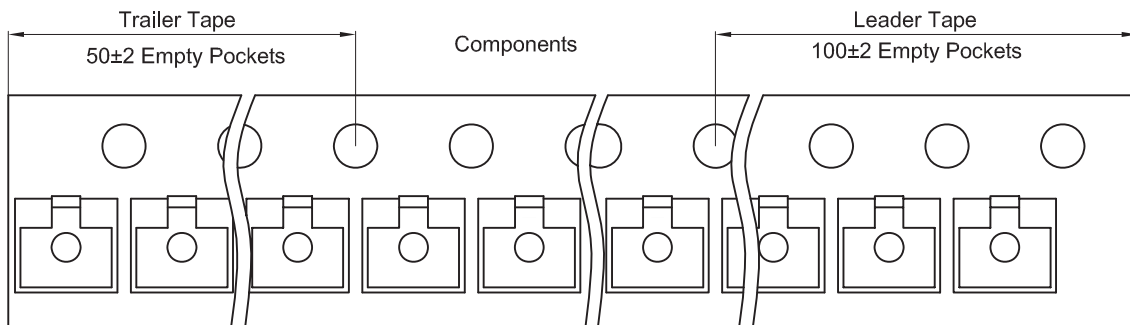
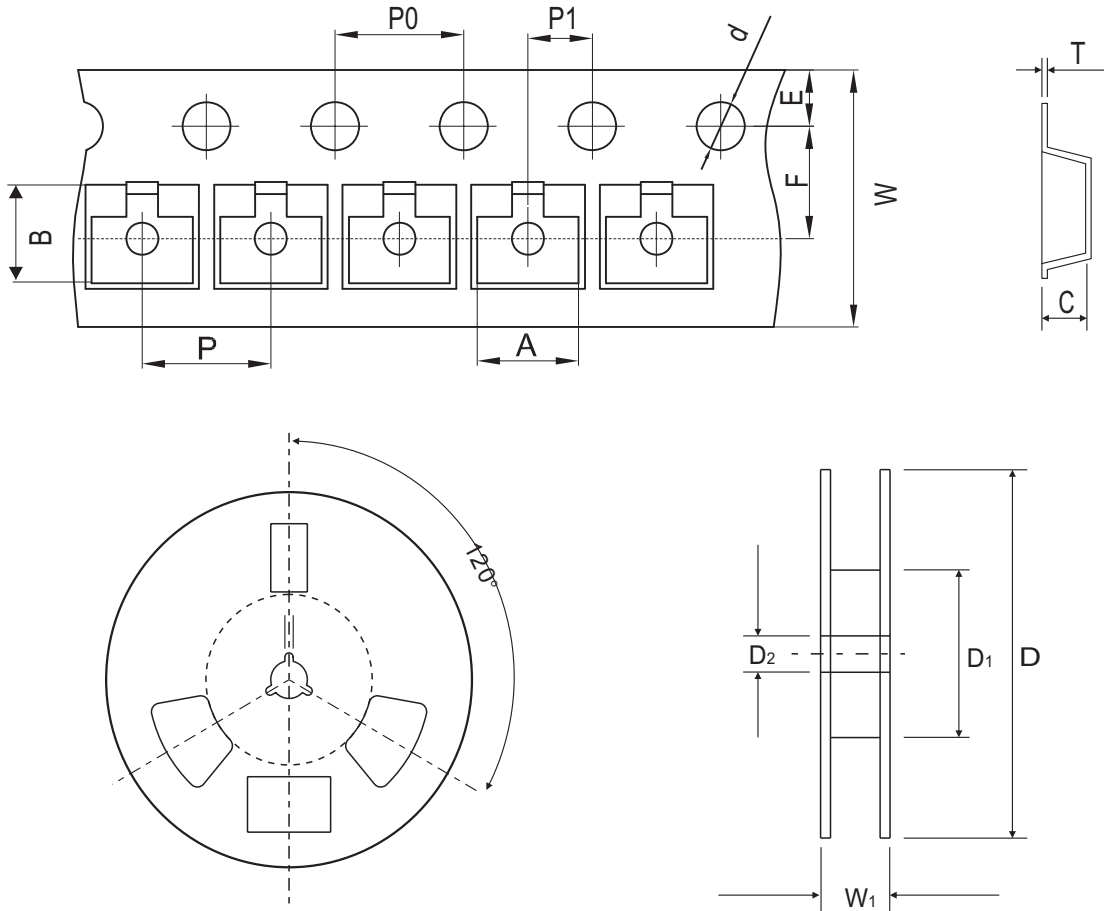

SOT-23	SYMBOL	A	B	C	d	D	D1	D2
	(mm)	3.15 ± 0.10	2.77 ± 0.10	1.22 ± 0.10	1.50 ± 0.10	178 ± 2.00	54.40 ± 1.00	13.00 ± 1.00
	(inch)	0.124 ± 0.004	0.109 ± 0.004	0.048 ± 0.004	0.059 ± 0.004	7.008 ± 0.079	2.142 ± 0.039	0.512 ± 0.039

SOT-23	SYMBOL	E	F	P	P0	P1	W	W1
	(mm)	1.75 ± 0.10	3.50 ± 0.10	4.00 ± 0.10	4.00 ± 0.10	2.00 ± 0.10	8.00 + 0.30 / - 0.10	12.30 ± 1.00
	(inch)	0.069 ± 0.004	0.138 ± 0.004	0.157 ± 0.004	0.157 ± 0.004	0.079 ± 0.004	0.315 + 0.012 / - 0.004	0.484 ± 0.039

## Marking Code

Part Number	Marking Code
BC846A-G	1A
BC847A-G	1E
BC848A-G	1J
BC846B-G	1B
BC847B-G	1F
BC848B-G	1K
BC847C-G	1G
BC848C-G	1L

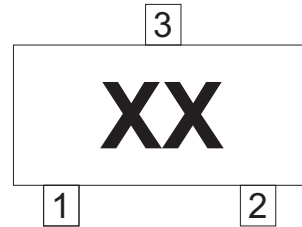

**xx = Product type marking code**

## Suggested PAD Layout

SIZE	SOT-23	
	(mm)	(inch)
A	0.80	0.031
B	1.90	0.075
C	2.02	0.080
D	2.82	0.111

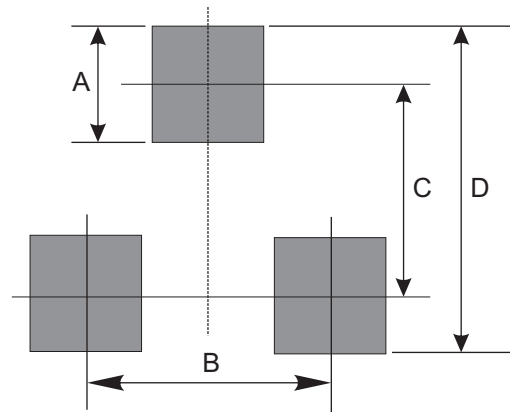

## Standard Packaging

Case Type	Qty Per Reel	Reel Size
	(Pcs)	(inch)
SOT-23	3,000	7