



Micro Commercial Components



Micro Commercial Components
20736 Marilla Street Chatsworth
CA 91311
Phone: (818) 701-4933
Fax: (818) 701-4939

ER3A THRU ER3M

Features

- Lead Free Finish/Rohs Compliant (Note1) ("P" Suffix designates Compliant. See ordering information)
- Epoxy meets UL 94 V-0 flammability rating
- Moisture Sensitivity Level 1
- Easy Pick And Place
- High Temp Soldering: 260°C for 10 Seconds At Terminals
- Super Fast Recovery Times For High Efficiency

**3 Amp Super Fast
Recovery
Silicon Rectifier
50 to 1000 Volts**

Maximum Ratings

- Operating Temperature: -50°C to +175°C
- Storage Temperature: -50°C to +175°C
- Typical Thermal Resistance; 16°C/W Junction To Lead

MCC Catalog Number	Device Marking	Maximum Recurrent Peak Reverse Voltage	Maximum RMS Voltage	Maximum DC Blocking Voltage
ER3A	ER3A	50V	35V	50V
ER3B	ER3B	100V	70V	100V
ER3C	ER3C	150V	105V	150V
ER3D	ER3D	200V	140V	200V
ER3G	ER3G	400V	280V	400V
ER3J	ER3J	600V	420V	600V
ER3K	ER3K	800V	560V	800V
ER3M	ER3M	1000V	700V	1000V

DO-214AB (SMC) (LEAD FRAME)

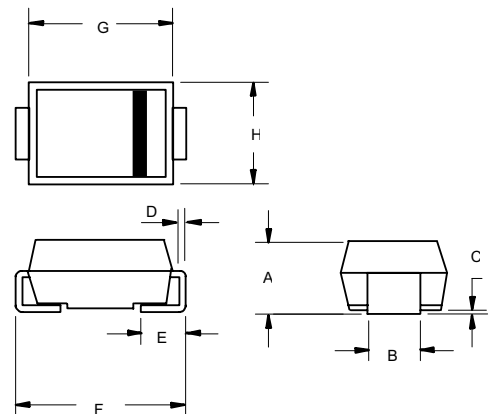

Electrical Characteristics @ 25°C Unless Otherwise Specified

Parameter	Symbol	Value	Conditions
Average Forward Current	$I_{F(AV)}$	3.0A	$T_L = 75^\circ\text{C}$
Peak Forward Surge Current	I_{FSM}	100A	8.3ms, half sine
Maximum Instantaneous Forward Voltage	V_F	ER3A-3D: .95V ER3G: 1.25V ER3J~3M: 1.70V	$I_{FM} = 3.0A$; $T_J = 25^\circ\text{C}^*$
Maximum DC Reverse Current At Rated DC Blocking Voltage	I_R	5 μA 200 μA	$T_J = 25^\circ\text{C}$ $T_J = 100^\circ\text{C}$
Maximum Reverse Recovery Time	T_{rr}	35ns 75ns	$I_F = 0.5A$, $I_R = 1.0A$, $I_{rr} = 0.25A$
Typical Junction Capacitance	C_J	45pF	Measured at 1.0MHz, $V_R = 4.0V$

DIM	INCHES		MM		NOTE
	MIN	MAX	MIN	MAX	
A	.079	.103	2.00	2.62	
B	.108	.128	2.75	3.25	
C	.002	.008	0.051	0.203	
D	.006	.012	0.152	0.305	
E	.030	.050	0.76	1.27	
F	.305	.320	7.75	8.13	
G	.260	.280	6.60	7.11	
H	.220	.245	5.59	6.22	

SUGGESTED SOLDER PAD LAYOUT

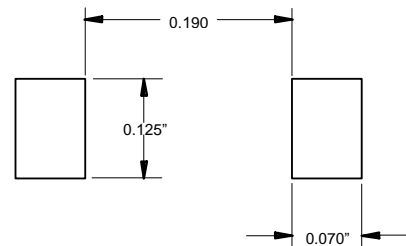

*Pulse test: Pulse width 300 μsec , Duty cycle 2%

1. High Temperature Solder Exemptions Applied, see EU Directive Annex 7.

www.mccsemi.com

ER3A thru ER3M

Figure 1
Typical Forward Characteristics

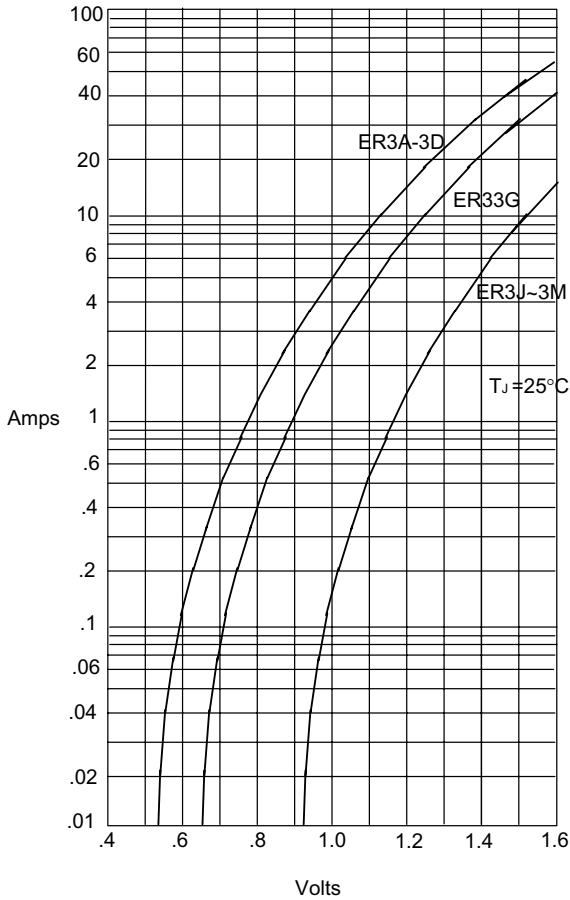

Instantaneous Forward Current - Amperes versus
Instantaneous Forward Voltage - Volts

Figure 2
Forward Derating Curve

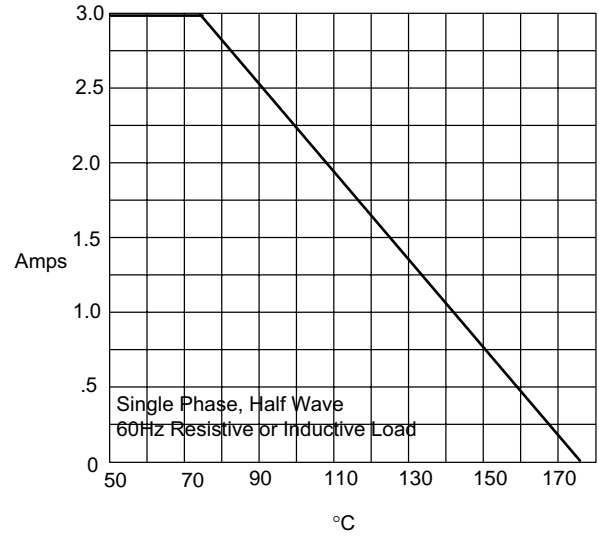

Average Forward Rectified Current - Amperes versus
Lead Temperature - $^\circ\text{C}$

Figure 3
Typical Junction Capacitance

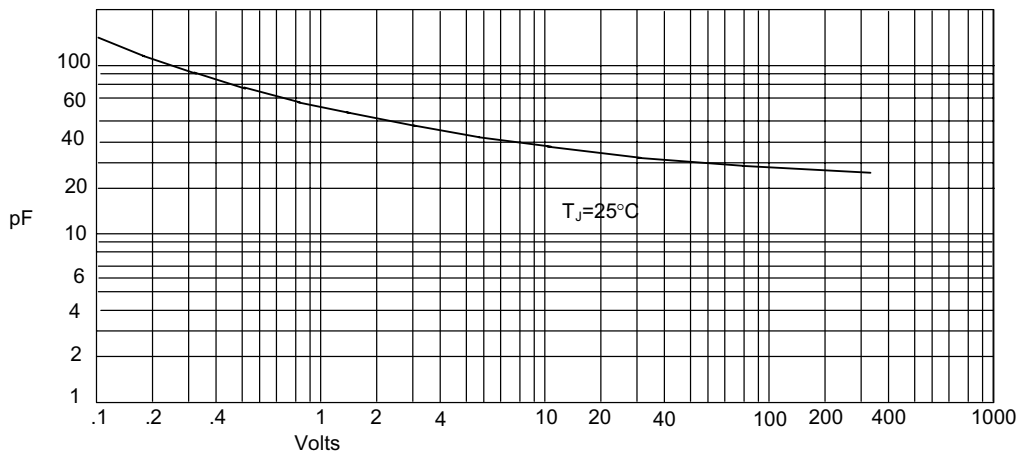

Junction Capacitance - pF versus
Reverse Voltage - Volts

ER3A thru ER3M

Figure 4
Typical Reverse Characteristics

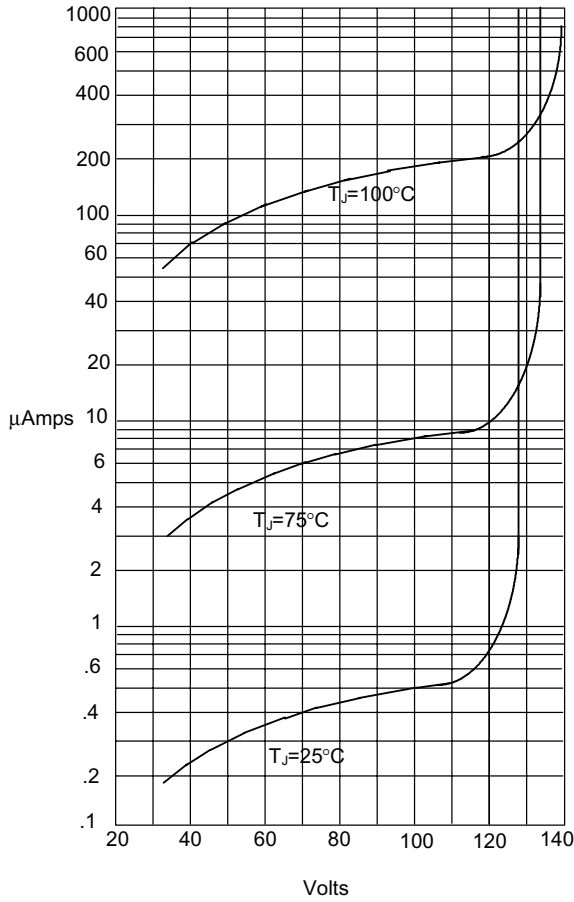

Instantaneous Reverse Leakage Current - MicroAmperes versus Percent Of Rated Peak Reverse Voltage - Volts

Figure 5
Peak Forward Surge Current

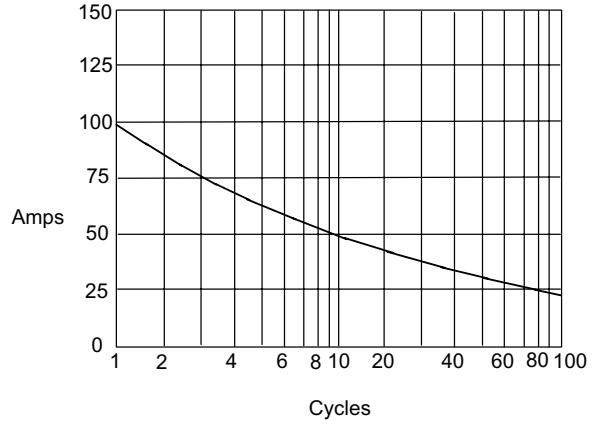

Peak Forward Surge Current - Amperes versus Number Of Cycles At 60Hz - Cycles

Figure 6
Reverse Recovery Time Characteristic And Test Circuit Diagram

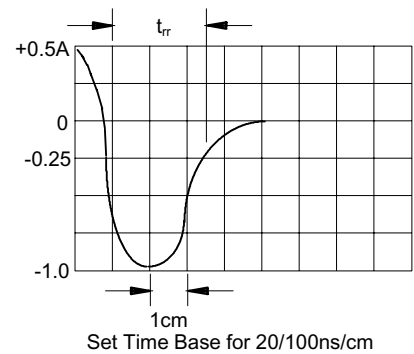
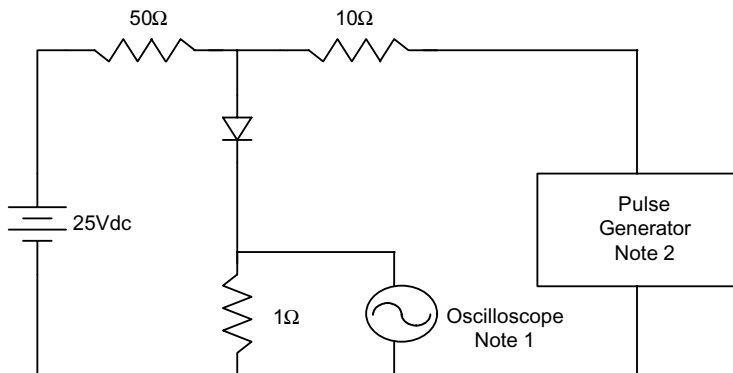

- Notes:
1. Rise Time = 7ns max.
Input impedance = 1 megohm, 22pF
 2. Rise Time = 10ns max.
Source impedance = 50 ohms
 3. Resistors are non-inductive



Micro Commercial Components

Ordering Information :

Device	Packing
Part Number-TP	Tape&Reel: 3Kpcs/Reel

*****IMPORTANT NOTICE*****

Micro Commercial Components Corp. reserves the right to make changes without further notice to any product herein to make corrections, modifications , enhancements , improvements , or other changes . **Micro Commercial Components Corp .** does not assume any liability arising out of the application or use of any product described herein; neither does it convey any license under its patent rights ,nor the rights of others . The user of products in such applications shall assume all risks of such use and will agree to hold **Micro Commercial Components Corp .** and all the companies whose products are represented on our website, harmless against all damages.

*****LIFE SUPPORT*****

MCC's products are not authorized for use as critical components in life support devices or systems without the express written approval of Micro Commercial Components Corporation.

*****CUSTOMER AWARENESS*****

Counterfeiting of semiconductor parts is a growing problem in the industry. Micro Commercial Components (MCC) is taking strong measures to protect ourselves and our customers from the proliferation of counterfeit parts. MCC strongly encourages customers to purchase MCC parts either directly from MCC or from Authorized MCC Distributors who are listed by country on our web page cited below. Products customers buy either from MCC directly or from Authorized MCC Distributors are genuine parts, have full traceability, meet MCC's quality standards for handling and storage. **MCC will not provide any warranty coverage or other assistance for parts bought from Unauthorized Sources.** MCC is committed to combat this global problem and encourage our customers to do their part in stopping this practice by buying direct or from authorized distributors.