

CDBZ2240-HF Thru. CDBZ2260-HF

Reverse Voltage: 40 ~ 60 Volts

Forward Current: 2.0 Amp

RoHS Device

Halogen free

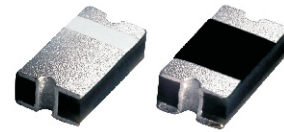

Features

- Lead less chip form, no lead damage.
- Low power loss, High efficiency.
- High current capability, low VF.
- Plastic package has Underwriters Laboratory Flammability Classification 94V-0 .

Mechanical data

- Case: Packed with FRP substrate and epoxy underfilled.
- Terminals: Pure Tin plated (Lead-Free), solderable per MIL-STD-750, method 2026.
- Weight : 0.012 grams.

Circuit Diagram

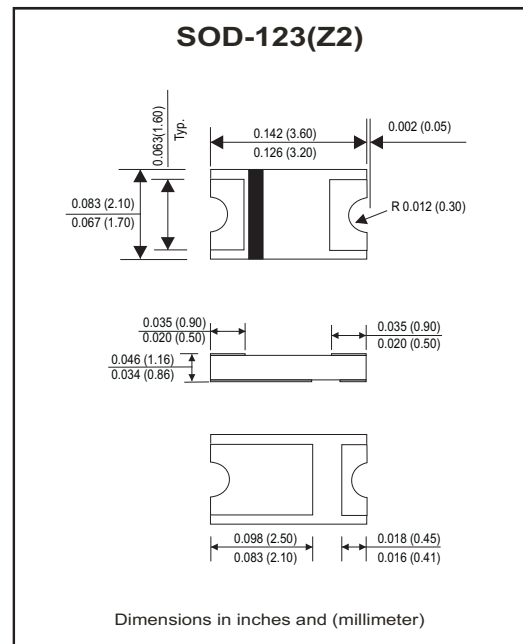

Maximum Ratings (at TA=25°C unless otherwise noted)

Parameter	Symbol	CDBZ2240-HF	CDBZ2260-HF	Unit
Repetitive peak reverse voltage	VRRM	40	60	V
Average forward current	IF(AV)	2.0		A
Peak forward surge current (8.3ms single half sine-wave)	IFSM	40		A
Operating junction temperature range	TJ	-55 to +125	-55 to +150	°C
Storage temperature range	TSTG	-55 to +150		°C

Company reserves the right to improve product design , functions and reliability without notice.

Electrical Characteristics (at TA=25°C unless otherwise noted)

Parameter		Symbol	Conditions	Min.	Typ.	Max.	Unit
Forward voltage (Note 1)	CDBZ2240-HF	V _F	I _F = 0.5 A	-	0.36	-	V
			I _F = 1.0 A	-	0.43	-	V
			I _F = 2.0 A	-	0.47	0.50	V
	CDBZ2260-HF	V _F	I _F = 0.5 A	-	0.40	-	V
			I _F = 1.0 A	-	0.48	-	V
			I _F = 2.0 A	-	0.58	0.70	V
Repetitive peak reverse current (Note 1)		I _{RRM}	V _R = Max. V _{RRM} , T _A = 25°C	-	0.03	0.2	mA
Junction capacitance		C _J	V _R = 4V, f = 1.0 MHz	-	115	-	pF
Thermal resistance	CDBZ2240-HF	R _{θJA}	Junction to ambient (Note 2)	-	75	-	°C/W
		R _{θJL}	Junction to lead (Note 2)	-	17	-	
	CDBZ2260-HF	R _{θJA}	Junction to ambient (Note 3)	-	135	-	°C/W
		R _{θJL}	Junction to lead (Note 3)	-	15	-	

NOTES : (1) Pulse test width PW=300usec , 1% duty cycle.
 (2) Mounted on P.C. board with 0.2 x 0.2"(5.0 x5.0mm) copper pad areas.
 (3) Mounted on P.C. board with recommend pad areas.

RATING AND CHARACTERISTIC CURVES (CDBZ2240-HF Thru. CDBZ2260-HF)

Fig.1 - Forward Current Derating Curve

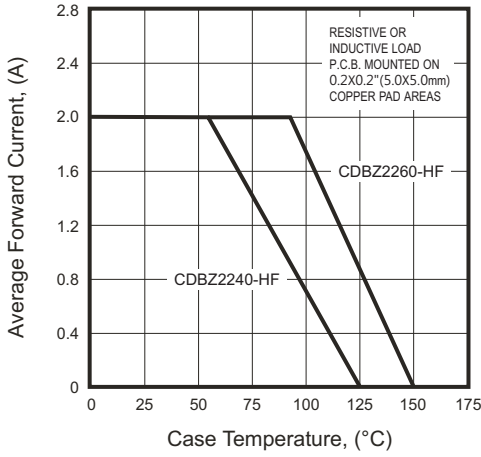

Fig.2 - Typical Forward Characteristics

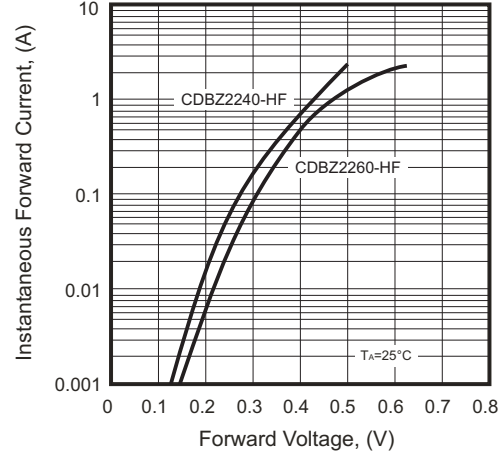

Fig.3 - Max. Non-repetitive Forward Peak Forward Surge Current

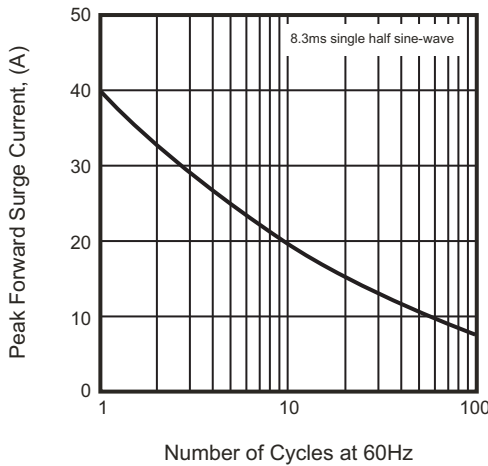

Fig.4 - Typical Reverse Characteristics

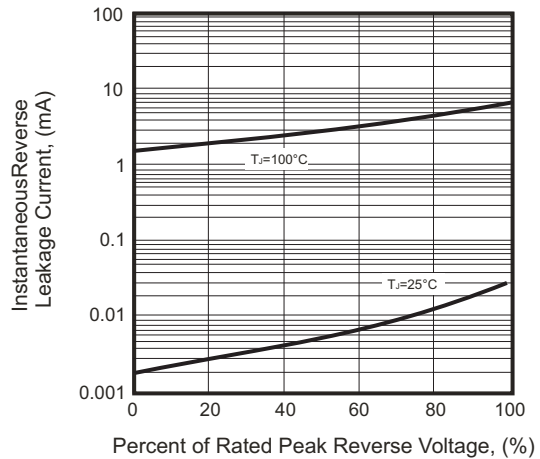
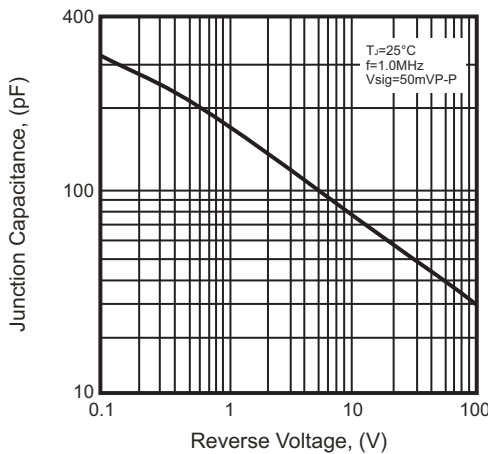
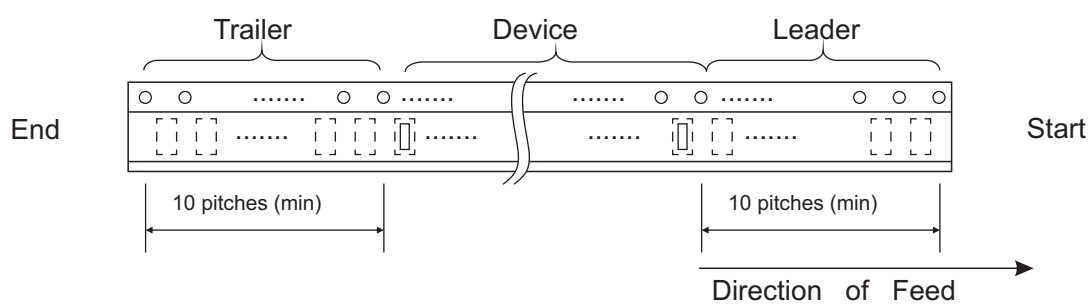
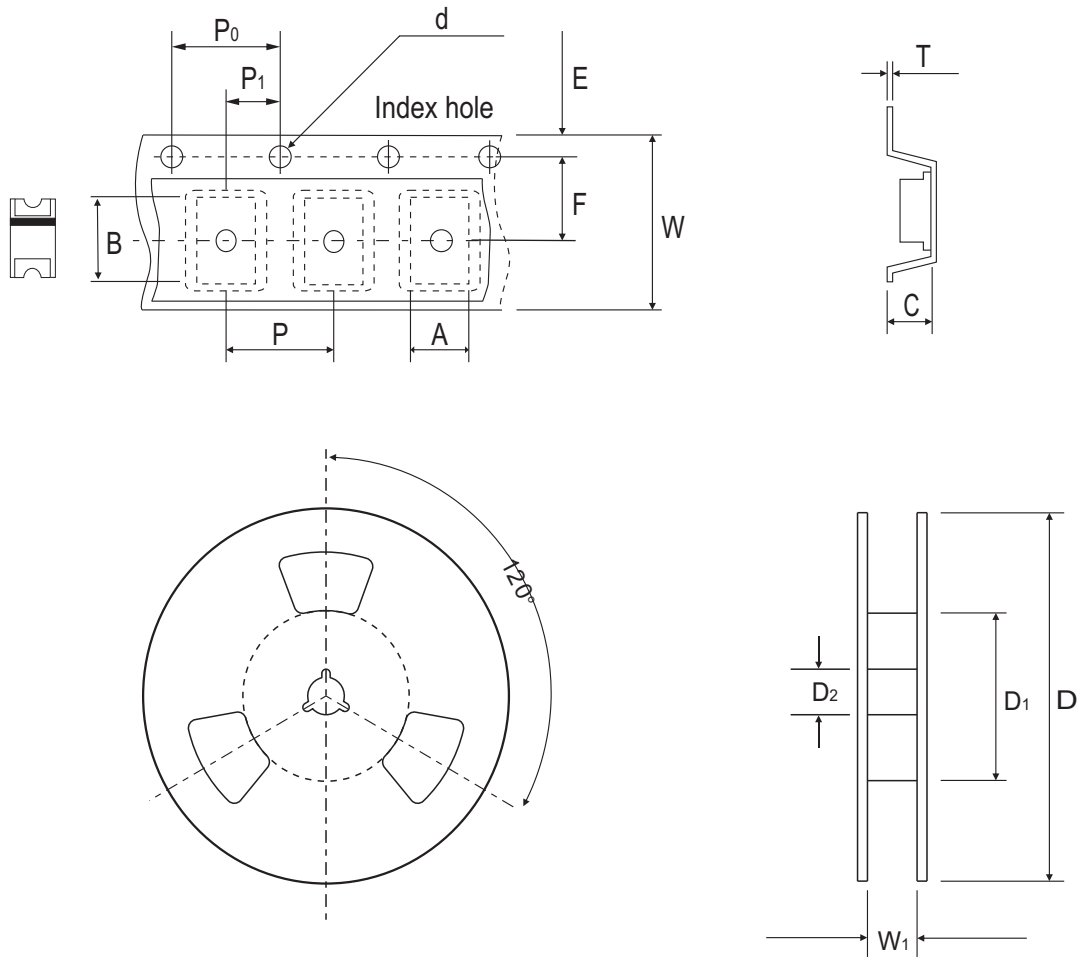

Fig.5 - Typical Junction Capacitance



Company reserves the right to improve product design, functions and reliability without notice.

Reel Taping Specification



SOD-123(Z2)	SYMBOL	A	B	C	d	D	D ₁	D ₂
	(mm)	2.20 ± 0.10	3.65 ± 0.10	1.28 ± 0.10	1.50 ± 0.10	178 ± 2.00	50.0 MIN.	13.0 ± 0.50
	(inch)	0.087 ± 0.004	0.144 ± 0.004	0.050 ± 0.004	0.059 ± 0.004	7.008 ± 0.079	1.969 MIN.	0.512 ± 0.020

SOD-123(Z2)	SYMBOL	E	F	P	P ₀	P ₁	W	W ₁
	(mm)	1.75 ± 0.10	5.50 ± 0.05	8.00 ± 0.10	4.00 ± 0.10	2.00 ± 0.10	12.00 ± 0.30	14.4 MAX.
	(inch)	0.069 ± 0.004	0.217 ± 0.002	0.315 ± 0.004	0.157 ± 0.004	0.079 ± 0.004	0.472 ± 0.012	0.567 MAX.

Company reserves the right to improve product design, functions and reliability without notice.

Marking Code

Part Number	Marking Code
CDBZ2240-HF	L4.
CDBZ2260-HF	L6.

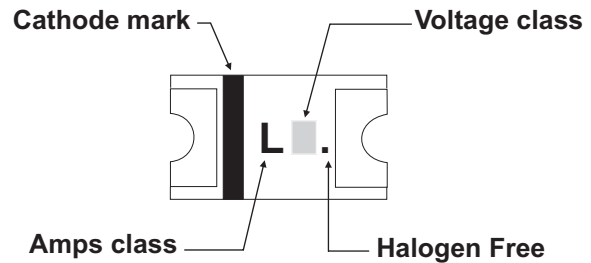

Suggested PAD Layout

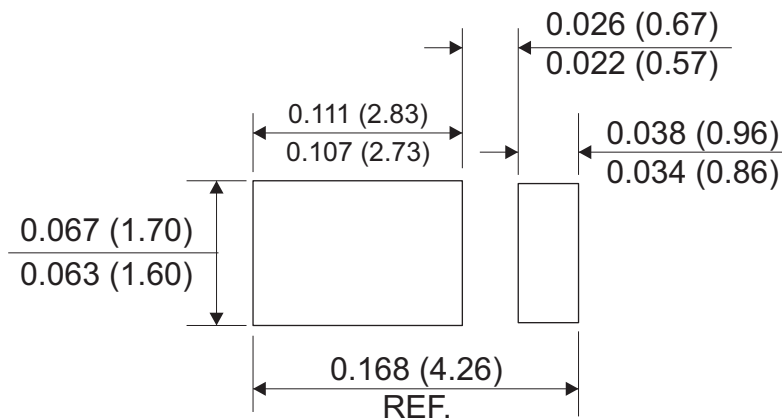

- NOTES : 1. Dimensions in inches and (millimeter)
2. The Layout is just for reference.

Standard Packaging

Case Type	REEL PACK	
	REEL (pcs)	Reel Size (inch)
SOD-123(Z2)	3,000	7