

CDST6-4448TI-G

RoHS Device

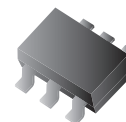

Features

- Fast switching speed.
- Ultra-small surface mount package.
- For general purpose switching applications.
- High conductance power dissipation.

Mechanical data

- Case: SOT-23-6, molded plastic.
- Terminals: Solder plated, solderable per MIL-STD-750, method 2026.
- Mounting position: Any.
- Weight: 0.015 gram (approx.)

Circuit diagram

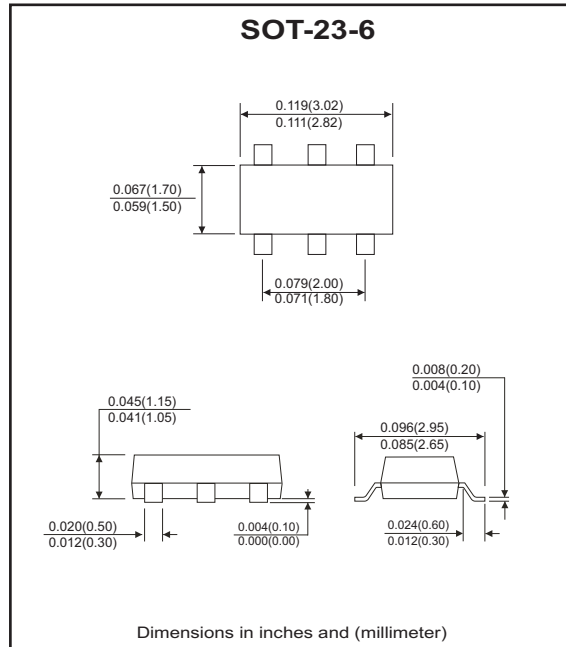
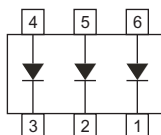

Maximum Ratings (at Ta=25°C unless otherwise noted)

Parameter	Symbol	Value	Unit
Non-repetitive peak reverse voltage	V _{RM}	100	V
Peak repetitive reverse voltage	V _{RRM}	75	V
Working peak reverse voltage	V _{RWM}		
DC Blocking voltage	V _R		
RMS Reverse voltage	V _{R(RMS)}	53	V
Average rectified output current	I _O	100	mA
Non-repetitive peak forward surge current @ t < 1us @ t < 1s	I _{FSM}	4 2	A
Power dissipation	P _d	200	mW
Operating and storage temperature range	T _J , T _{STG}	-55 to +150	°C

Electrical Characteristics (at Ta=25°C unless otherwise noted)

Parameter	Conditions	Symbol	Min	Typ	Max	Unit
Reverse breakdown voltage	I _R = 10uA	V _{BR}	75			V
Forward voltage	I _F = 1mA I _F = 10mA I _F = 100mA	V _F	0.62		0.720 0.855 1.0	V
Reverse current	V _R = 75V V _R = 75V, T _J = 150°C V _R = 25V, T _J = 150°C V _R = 20V	I _R			2.5 50 30 25	uA uA uA nA
Diode junction Capacitance	V _R = 0, f = 1.0MHz	C _J			4.0	pF
Reverse recovery time	I _F = I _R = 10mA I _{rr} = 0.1 x I _R , R _L = 100Ω	T _{rr}			4.0	nS

Company reserves the right to improve product design, functions and reliability without notice.

REV:C

RATING AND CHARACTERISTIC CURVES (CDST6-4448TI-G)

Fig.1 - Forward characteristics

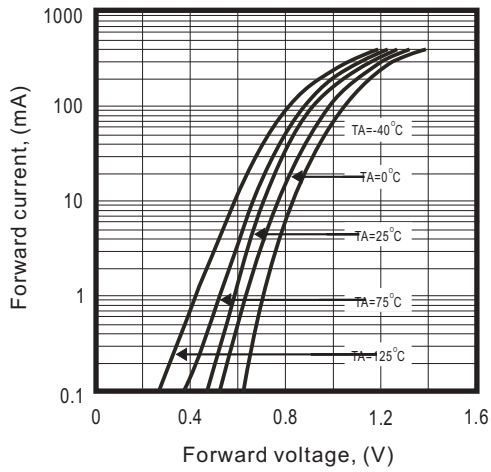

Fig.2 - Reverse characteristics

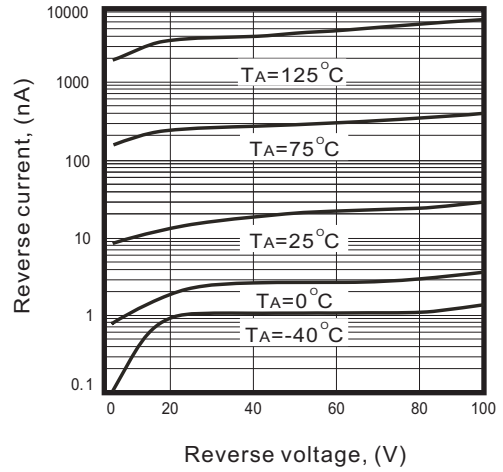

Fig.3 - Capacitance between terminals characteristics

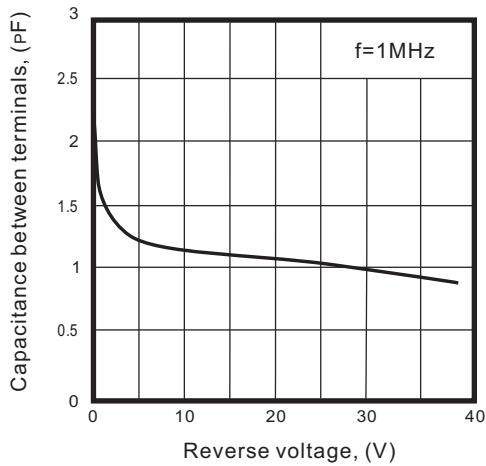

Fig.4 - Power derating curve

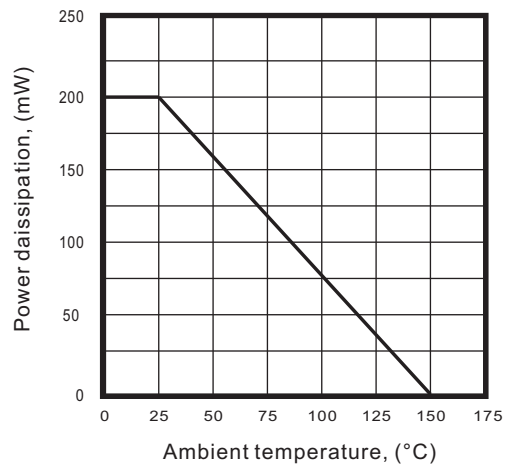
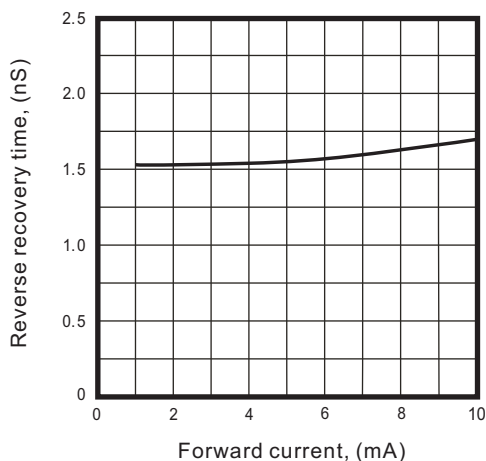

Fig.5 - Reverse recovery time vs. forward current



Company reserves the right to improve product design, functions and reliability without notice.

REV:C

Reel Taping Specification

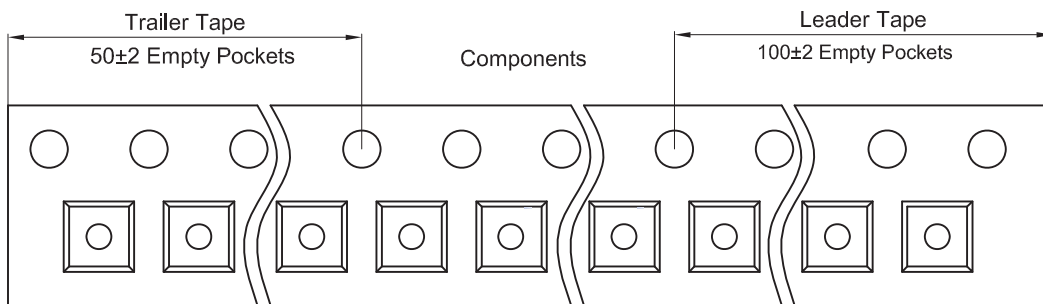
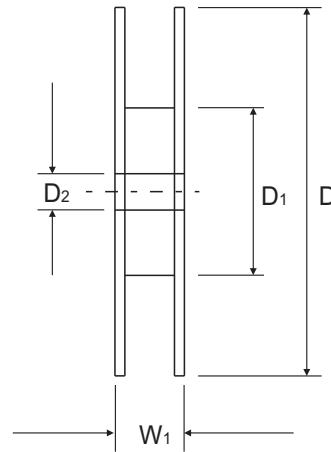
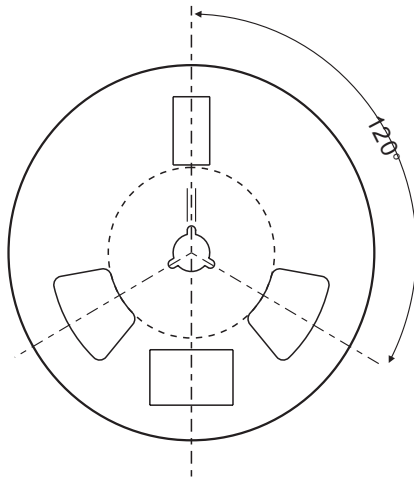
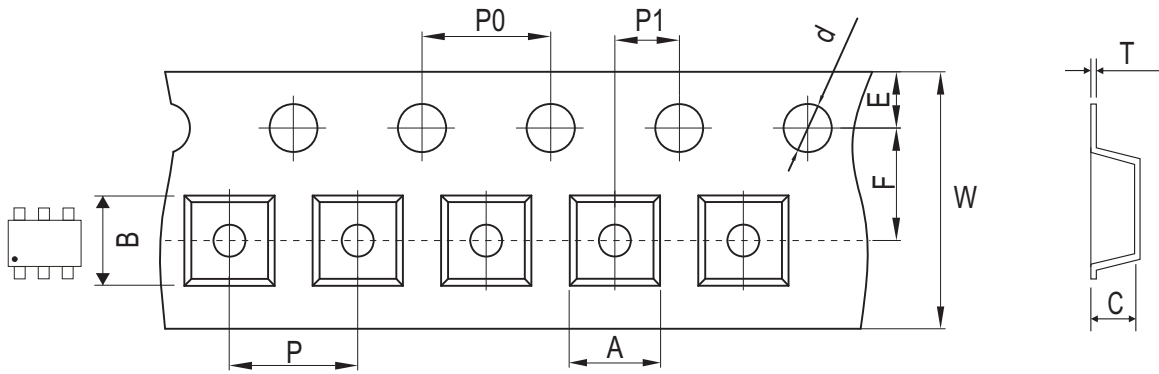

SOT-23-6	SYMBOL	A	B	C	d	D	D1	D2
	(mm)	3.17 ± 0.10	3.23 ± 0.10	1.37 ± 0.10	1.50 ± 0.05	180.0 + 0.00 / - 0.30	60.00 ± 0.50	13.00 ± 0.20
	(inch)	0.125 ± 0.004	0.127 ± 0.004	0.054 ± 0.004	0.059 ± 0.002	7.087 + 0.00 / - 0.012	2.362 ± 0.020	0.512 ± 0.008

SOT-23-6	SYMBOL	E	F	P	P0	P1	W	W1
	(mm)	1.75 ± 0.10	3.50 ± 0.05	4.00 ± 0.10	4.00 ± 0.10	2.00 ± 0.05	8.00 + 0.30 / - 0.10	12.30 ± 0.20
	(inch)	0.069 ± 0.004	0.138 ± 0.002	0.157 ± 0.004	0.157 ± 0.004	0.079 ± 0.002	0.315 + 0.012 / - 0.004	0.484 ± 0.008

Company reserves the right to improve product design, functions and reliability without notice.

REV:C

Marking Code

Part Number	Marking Code
CDST6-4448TI-G	KAA

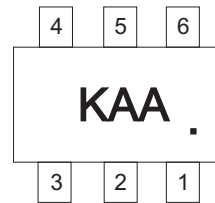

Suggested PAD Layout

SIZE	SOT-23-6	
	(mm)	(inch)
A	1.10	0.043
B	0.60	0.024
C	0.95	0.037
D	2.50	0.098
E	3.60	0.142

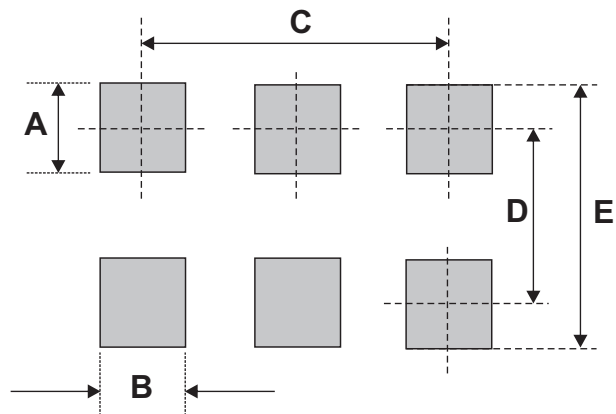

Standard Packaging

Case Type	REEL PACK	
	REEL (pcs)	Reel Size (inch)
SOT-23-6	3,000	7