

ACZRW4689-G

Voltage: 5.1Volts

Power: 350mW

RoHS Device

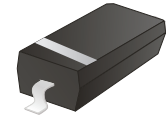

Features

- For surface mounted applications.
- Wide zener reverse voltage range.
- Small package size for high density applications.
- ESD Rating of class 3(>16KV) per human body model.
- MAXIMUM Case temperature for soldering purposes: 260°C for 10 Seconds
- Comply with AEC-Q101

Mechanical data

- Case: SOD-123, Void-free, transfer-molded, thermosetting plastic case.
- Finish: Corrosion resistant finish, easily solderable.
- Terminals: Solder Plated, solderable per MIL-STD-750, method 2026.
- Polarity: Cathode band.
- Weight: 0.01 gram(approx.).

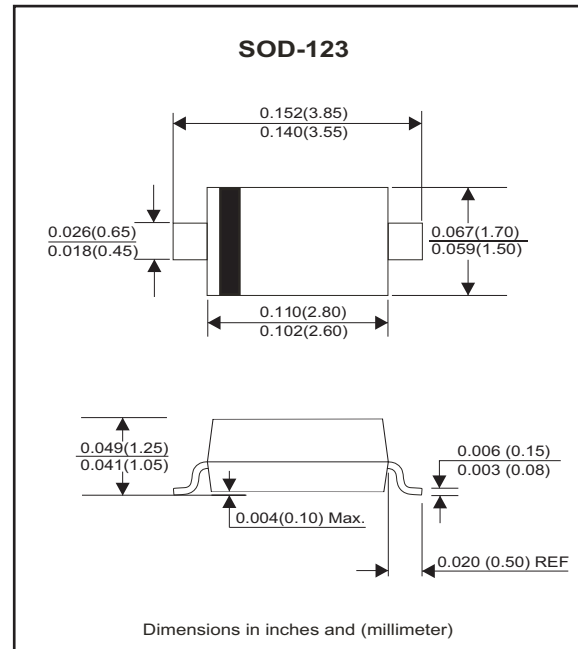

Circuit diagram



Maximum Rating (@T_A=25°C unless otherwise specified)

Parameter	Symbol	Value	Unit
Maximum forward voltage @ I _F =10mA	V _F	0.9	V
Maximum power dissipation	P _D	350	mW
Thermal Resistance, Junction to Ambient Air	R _{θJA}	357	°C/W
Junction Temperature Range	T _J	-65 to +150	°C
Storage Temperature Range	T _{STG}	-65 to +150	°C

Notes: Device mounted on ceramic PCB; 5.0mm*7.0mm with pad areas 35mm².

Electrical Characteristics (at T_A = 25°C unless otherwise noted)

Part Number	Zener Voltage (Note 1)			Leakage Current		Marking Code	
	V _Z (Volts)			@IZT	I _R @V _R		
	Min	Nom	Max	µA	µA		Volts
CZRW4689-G	4.85	5.1	5.36	50	10	3.0	CU

Notes: 1. Nominal Zener voltage is measured with the device junction in thermal equilibrium at T_L=30°C ±1°C

RATING AND CHARACTERISTIC CURVES (ACZRW4689-G)

Fig.1 - Forward characteristics

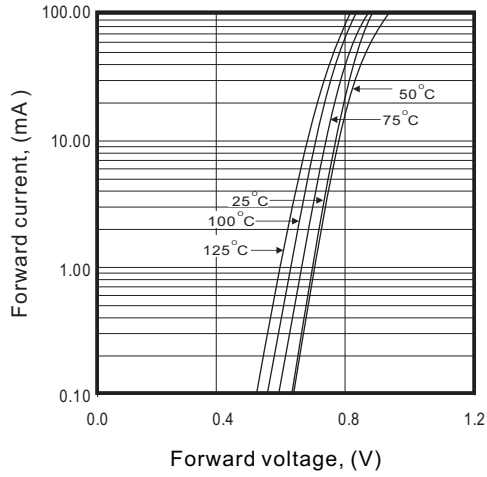

Fig.2 - Reverse characteristic

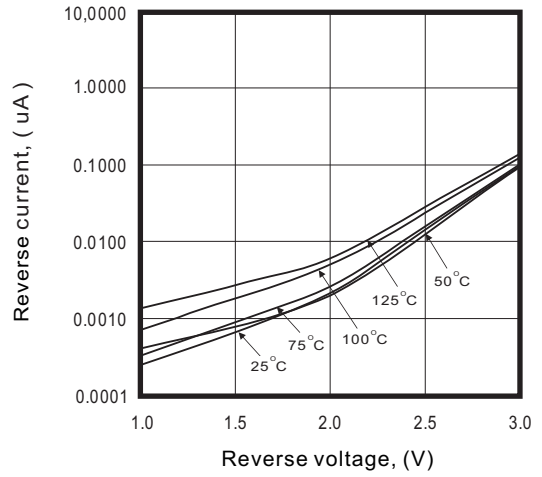

Fig.3 - Capacitance between terminals characteristics

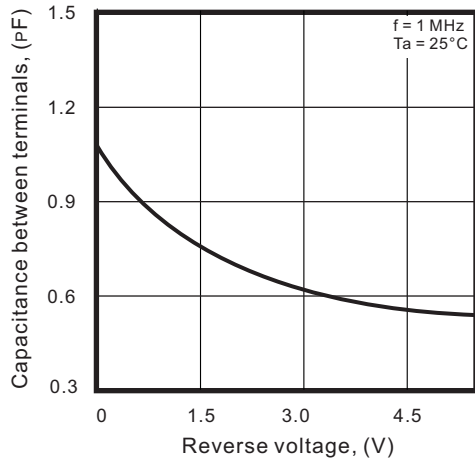
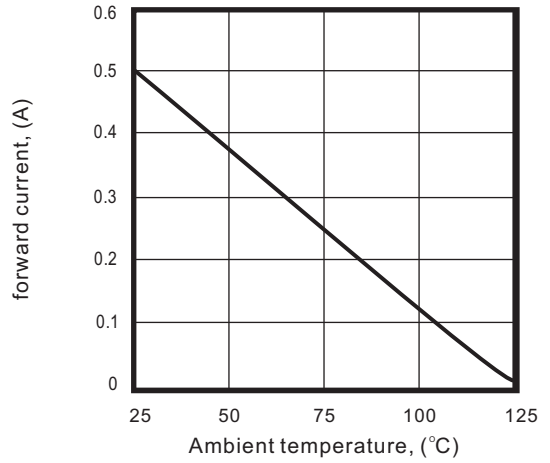
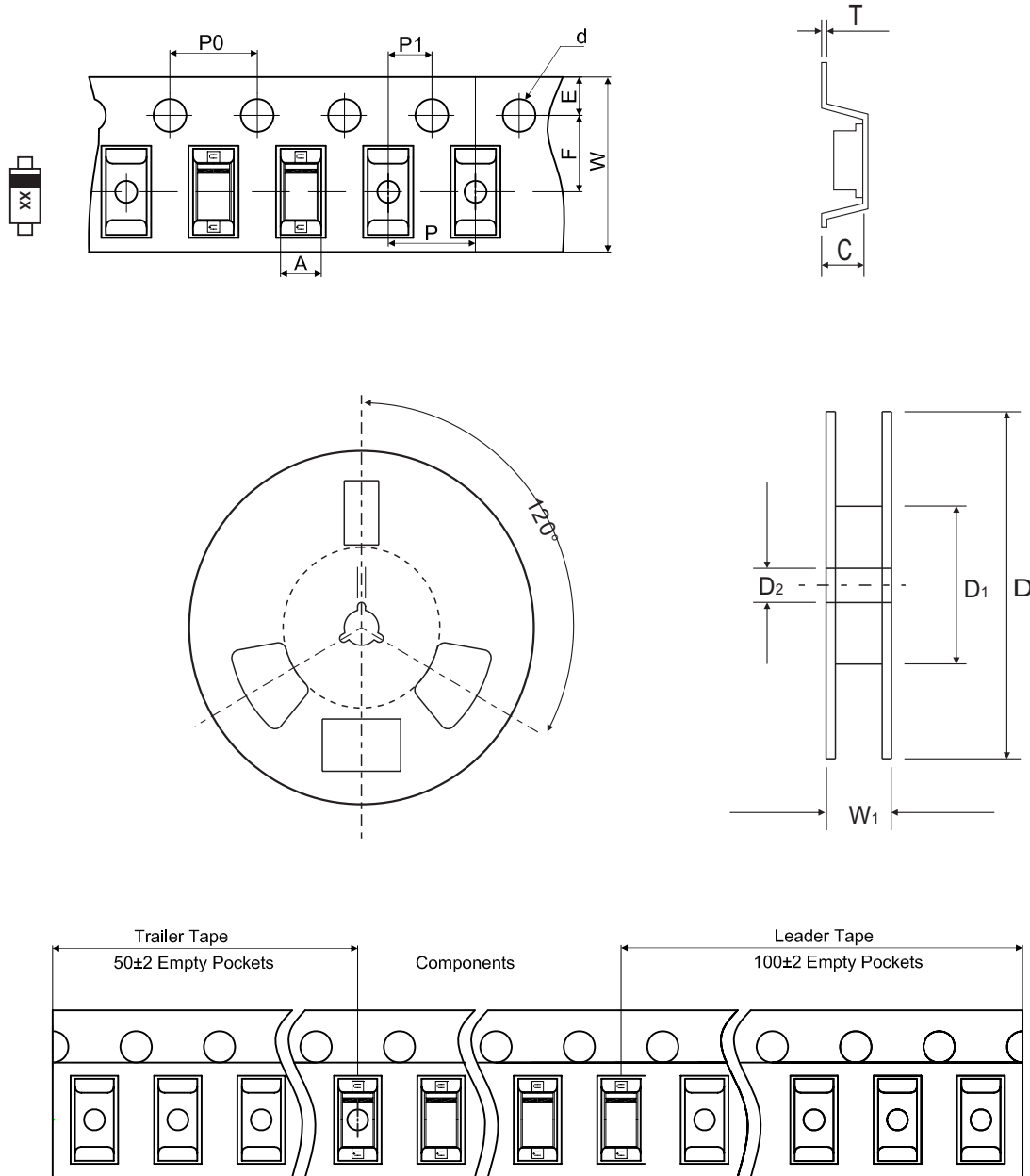

Fig.4 - Power derating



Reel Taping Specification



SOD-123	SYMBOL	A	B	C	d	D	D ₁	D ₂
	(mm)	1.85 ± 0.05	3.94 ± 0.05	1.57 ± 0.05	1.55 ± 0.10	178 ± 2.00	54.40 ± 1.00	13.00 ± 1.00
	(inch)	0.073 ± 0.002	0.155 ± 0.002	0.062 ± 0.002	0.061 ± 0.004	7.008 ± 0.079	2.142 ± 0.039	0.512 ± 0.039

SOD-123	SYMBOL	E	F	P	P ₀	P ₁	W	W ₁
	(mm)	1.75 ± 0.10	3.50 ± 0.10	4.00 ± 0.10	4.00 ± 0.10	2.00 ± 0.10	8.00 + 0.30 / - 0.10	12.30 ± 1.0
	(inch)	0.069 ± 0.004	0.138 ± 0.004	0.157 ± 0.004	0.157 ± 0.004	0.079 ± 0.004	0.315 + 0.012 / - 0.004	0.484 ± 0.039

Marking Code

Part Number	Marking Code
ACZRW4689-G	CU



Suggested PAD Layout

SIZE	SOD-123	
	(mm)	(inch)
A	3.24	0.128
B	0.80	0.031
C	1.00	0.039
D	4.04	0.159
E	2.44	0.096

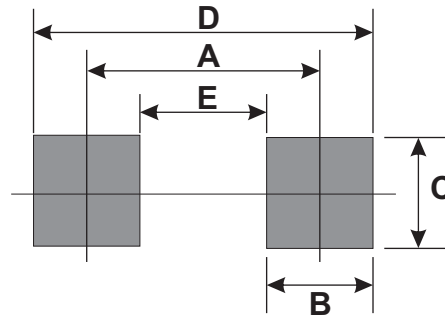

Standard Packaging

Case Type	REEL PACK	
	REEL (pcs)	Reel Size (inch)
SOD-123	3,000	7