

## 1N4728A-G Thru. Z1330A-G

Zener Voltage: 3.3 to 330 Volts

DC Power: 1 Watts

RoHS Device



### Features

- Glass passivated chip.
- Low leakage.
- Built-in strain relief.
- Low inductance.
- High peak reverse power dissipation.
- For use in stabilizing and clipping with high power rating.

### Mechanical data

- Case: Molded plastic.
- Epoxy: UL 94V-0 rate flame retardant.
- Terminals: Solderable per MIL-STD-202, method 208 guaranteed.
- Polarity: Color band denotes cathode end.
- Mounting position: Any.
- Approx. weight: 0.35 grams(approx.).

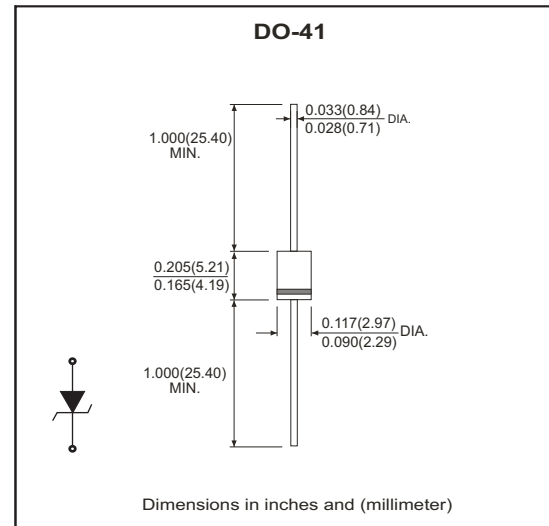

### Maximum Ratings and Electrical Characteristics

Ratings at 25°C ambient temperature unless otherwise specified.  
Single phase, half wave, 60Hz, resistive or inductive load.  
For capacitive load, derate current by 20%.

Characteristics	Symbol	Value	Units
DC power dissipation at $T_L=50^\circ\text{C}$ (Note 1)	$P_D$	1	W
Maximum forward voltage at $I_F=200\text{ mA}$	$V_F$	1.2	V
Maximum thermal resistance junction to ambient air (Note 2)	$R_{\theta JA}$	170	K/W
Junction temperature range	$T_J$	-55 to +175	$^\circ\text{C}$
Storage temperature range	$T_{STG}$	-55 to +175	$^\circ\text{C}$

Notes:

1.  $T_L$ = Lead temperature at 3/8" (9.5mm) from body.
2. Valid provided that leads are kept at ambient temperature at a distance of 10mm from case.

# Axial Lead Zener Diode

## Electrical Characteristics (1N4728A-G Thru. Z1330A-G)

Part No	Nominal Zener Voltage		Maximum Zener Impedance			Maximum Reverse Leakage Current		Maximum DC Zener Current	Maximum Surge Current	Marking Code
	V <sub>Z</sub> @I <sub>ZT</sub>	I <sub>ZT</sub>	Z <sub>ZT</sub> @I <sub>ZT</sub>	Z <sub>ZK</sub> @I <sub>ZK</sub>	I <sub>ZK</sub>	I <sub>R</sub> @V <sub>R</sub>		I <sub>ZM</sub>	I <sub>RM</sub>	
	(V)	(mA)	(Ω)	(Ω)	(mA)	(μA)	(V)	(mA)	(mApk)	
1N4728A-G	3.3	76.00	10	400	1.00	100	1.0	274.00	1370	1N4728A
1N4729A-G	3.6	69.00	10	400	1.00	100	1.0	251.00	1255	1N4729A
1N4730A-G	3.9	64.00	9.0	400	1.00	50	1.0	232.00	1160	1N4730A
1N4731A-G	4.3	58.00	9.0	400	1.00	10	1.0	210.00	1050	1N4731A
1N4732A-G	4.7	53.00	8.0	500	1.00	10	1.0	192.00	960	1N4732A
1N4733A-G	5.1	49.00	7.0	550	1.00	10	1.0	177.00	885	1N4733A
1N4734A-G	5.6	45.00	5.0	600	1.00	10	2.0	161.00	805	1N4734A
1N4735A-G	6.2	41.00	2.0	700	1.00	10	3.0	146.00	730	1N4735A
1N4736A-G	6.8	37.00	3.5	700	1.00	5.0	4.0	133.00	660	1N4736A
1N4737A-G	7.5	34.00	4.0	700	0.50	5.0	5.0	121.00	605	1N4737A
1N4738A-G	8.2	31.00	4.5	700	0.50	5.0	6.0	110.00	550	1N4738A
1N4739A-G	9.1	28.00	5.0	700	0.50	0.5	7.0	100.00	500	1N4739A
1N4740A-G	10.0	25.00	7.0	700	0.25	0.5	7.6	91.00	454	1N4740A
1N4741A-G	11.0	23.00	8.0	700	0.25	0.1	8.4	83.00	414	1N4741A
1N4742A-G	12.0	21.00	9.0	700	0.25	0.1	9.1	76.00	380	1N4742A
1N4743A-G	13.0	19.00	10.0	700	0.25	0.1	9.9	69.00	344	1N4743A
1N4744A-G	15.0	17.00	14.0	700	0.25	0.1	11.4	61.00	305	1N4744A
1N4745A-G	16.0	15.50	16.0	700	0.25	0.1	12.2	57.00	285	1N4745A
1N4746A-G	18.0	14.00	20.0	750	0.25	0.1	13.7	50.00	250	1N4746A
1N4747A-G	20.0	12.50	22.0	750	0.25	0.1	15.2	45.00	225	1N4747A
1N4748A-G	22.0	11.50	23.0	750	0.25	0.1	16.7	41.00	205	1N4748A
1N4749A-G	24.0	10.50	25.0	750	0.25	0.1	18.2	38.00	190	1N4749A
1N4750A-G	27.0	9.50	35.0	750	0.25	0.1	20.6	34.00	170	1N4750A
1N4751A-G	30.0	8.50	40.0	1000	0.25	0.1	22.8	30.00	150	1N4751A
1N4752A-G	33.0	7.50	45.0	1000	0.25	0.1	25.1	27.00	135	1N4752A
1N4753A-G	36.0	7.00	50.0	1000	0.25	0.1	27.4	25.00	125	1N4753A
1N4754A-G	39.0	6.50	60.0	1000	0.25	0.1	29.7	23.00	115	1N4754A
1N4755A-G	43.0	6.00	70.0	1500	0.25	0.1	32.7	22.00	110	1N4755A
1N4756A-G	47.0	5.50	80.0	1500	0.25	0.1	35.8	19.00	95	1N4756A
1N4757A-G	51.0	5.00	95.0	1500	0.25	0.1	38.8	18.00	90	1N4757A
1N4758A-G	56.0	4.50	110.0	2000	0.25	0.1	42.6	16.00	80	1N4758A
1N4759A-G	62.0	4.00	125.0	2000	0.25	0.1	47.1	14.00	70	1N4759A
1N4760A-G	68.0	3.70	150.0	2000	0.25	0.1	51.7	13.00	65	1N4760A
1N4761A-G	75.0	3.30	175.0	2000	0.25	0.1	56.0	12.00	60	1N4761A
1N4762A-G	82.0	3.00	200.0	3000	0.25	0.1	62.2	11.00	55	1N4762A
1N4763A-G	91.0	2.80	250.0	3000	0.25	0.1	69.2	10.00	50	1N4763A
1N4764A-G	100.0	2.50	350.0	3000	0.25	0.1	76.0	9.00	45	1N4764A

Notes:

1. The type number listed have a standard tolerance on the nominal zener voltage of ± 5%.
2. The reverse surge current is a non-repetitive, 8.3ms pulse width square wave or equivalent sine-wave superimposed on I<sub>ZT</sub> per JEDEC method.

Company reserves the right to improve product design , functions and reliability without notice.

REV:B

# Axial Lead Zener Diode

## Electrical Characteristics (1N4728A-G Thru. Z1330A-G)

Part No	Nominal Zener Voltage		Maximum Zener Impedance			Maximum Reverse Leakage Current		Maximum DC Zener Current	Maximum Surge Current	Marking Code
	V <sub>Z</sub> @I <sub>ZT</sub>	I <sub>ZT</sub>	Z <sub>ZT</sub> @I <sub>ZT</sub>	Z <sub>ZK</sub> @I <sub>ZK</sub>	I <sub>ZK</sub>	I <sub>R</sub> @V <sub>R</sub>		I <sub>ZM</sub>	I <sub>RM</sub>	
	(V)	(mA)	(Ω)	(Ω)	(mA)	(μA)	(V)	(mA)	(mA <sub>pk</sub> )	
Z1110A-G	110.0	2.30	450.0	4000	0.25	0.1	83.6	8.60	40	Z1110A
Z1120A-G	120.0	2.00	550.0	4500	0.25	0.1	91.2	7.80	37	Z1120A
Z1130A-G	130.0	1.90	700.0	5000	0.25	0.1	98.8	7.00	34	Z1130A
Z1150A-G	150.0	1.70	1000.0	6000	0.25	0.1	114.0	6.40	30	Z1150A
Z1160A-G	160.0	1.60	1100.0	6500	0.25	0.1	121.6	5.80	28	Z1160A
Z1180A-G	180.0	1.40	1200.0	7000	0.25	0.1	136.8	5.20	25	Z1180A
Z1200A-G	200.0	1.20	1900.0	9990	0.25	0.1	152.0	4.70	22	Z1200A
Z1220A-G	220.0	1.10	1600.0	8000	0.25	0.1	167.2	4.00	20	Z1220A
Z1240A-G	240.0	0.90	1800.0	8500	0.25	0.1	182.4	3.80	19	Z1240A
Z1250A-G	250.0	0.90	2000.0	9000	0.25	0.1	190.0	3.60	18	Z1250A
Z1270A-G	270.0	0.80	2100.0	9000	0.25	0.1	205.0	3.30	16	Z1270A
Z1300A-G	300.0	0.80	2300.0	9500	0.25	0.1	228.0	3.00	15	Z1300A
Z1330A-G	330.0	0.70	2500.0	9500	0.25	0.1	250.0	2.70	13	Z1330A

Notes:

1. The type number listed have a standard tolerance on the nominal zener voltage of  $\pm 5\%$ .
2. The reverse surge current is a non-repetitive, 8.3ms pulse width square wave or equivalent sine-wave superimposed on I<sub>ZT</sub> per JEDEC method.

## RATING AND CHARACTERISTIC CURVES (1N4728A-G Thru. Z1330A-G)

Fig.1 - Power Temperature Derating Curve

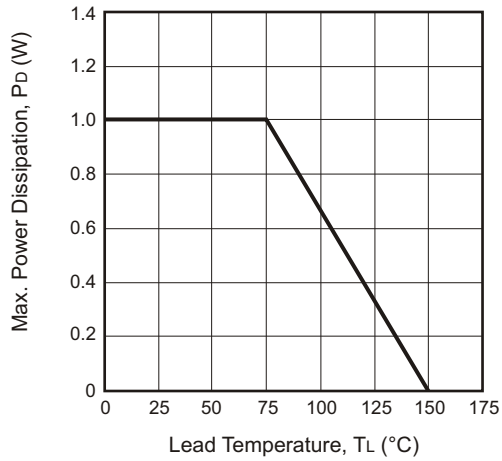

Fig.2 - Temperature Coefficients v.s. Zener Voltage

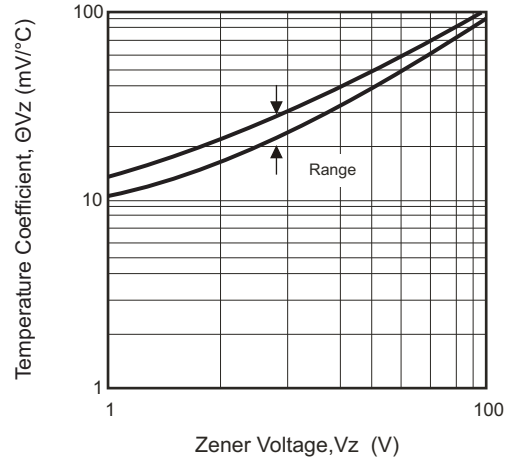

Fig.3 - Typical Thermal Resistance v.s. Lead Length

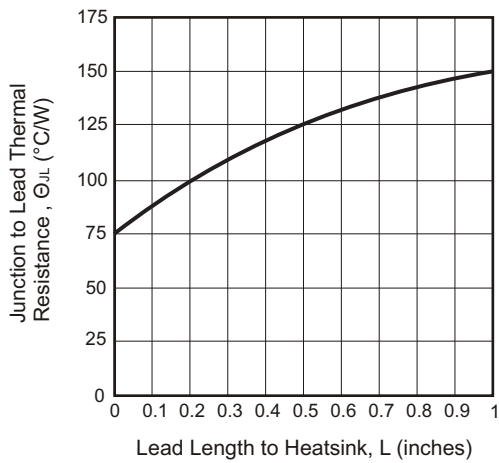
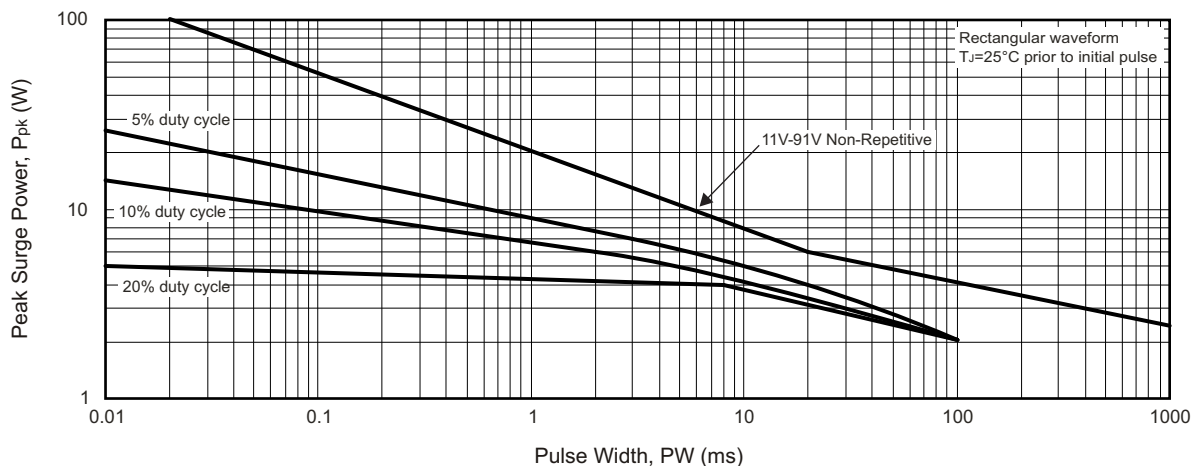

Fig.4 - Maximum Surge Power



Company reserves the right to improve product design, functions and reliability without notice.

REV:B

## Taping Specification For Axial Lead Diodes

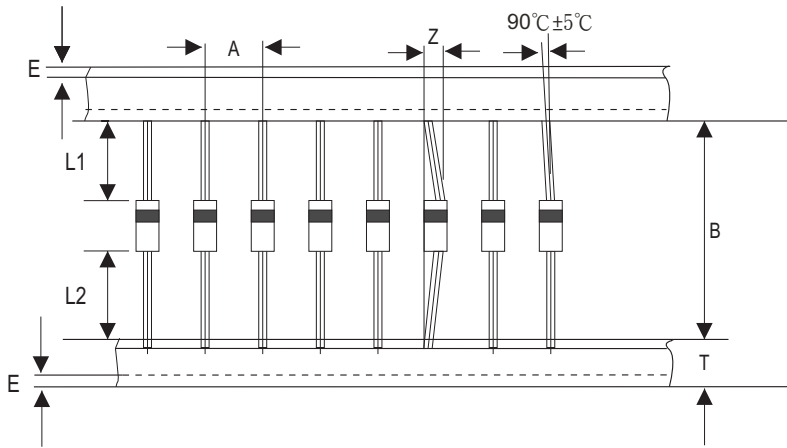

DO-41	SYMBOL	A	B	Z	T	E	L1-L2
	(mm)	5.00 ± 0.5	52.0 ± 0.5	1.2 (max)	6.0 ± 0.4	3 (max)	1.0 (max)
	(inch)	0.197 ± 0.020	2.047 ± 0.020	0.047 (max)	0.236 ± 0.016	0.118 (max)	0.039 (max)

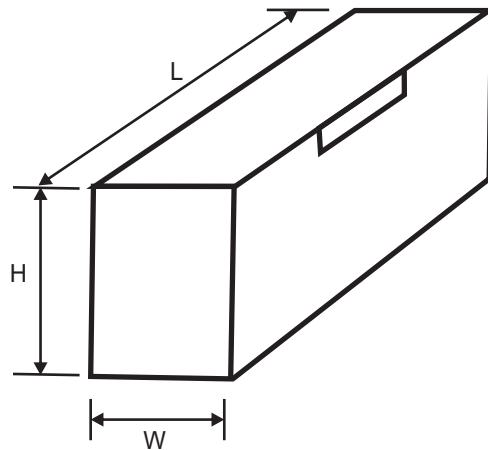

## Standard Packaging

Case Type	AMMO PACK	
	BOX ( pcs )	CARTON ( pcs )
DO-41	5,000	50,000