



ProsPower

PS4953A

30V Dual Channel PMOSEFT

Revision : 1.0
Update Date : Apr. 2011

ProsPower Microelectronics Co., Ltd

1. General Description

The PS4953A uses advanced trench technology and design to provide excellent $R_{ds(on)}$ with low gate charge and operation with gate voltages as low as 2.5V. This device is suitable for use as a load switch or in PWM applications. Standard Product PS4953A is Pb-free (meets ROHS & Sony 259 specifications). It is offered in the very popular SOP8 package

2. Applications

- PWM applications
- Load switch
- Power management

3. Features

- $V_{ds}=-30V$, $I_d=-6A$
- $R_{ds(on)}=52m\Omega$ ($V_{gs}=-10V$)
- $R_{ds(on)}=67m\Omega$ ($V_{gs}=-4.5V$)
- High Power and current handling capability
- Low capacitance minimizes driver loss
- Optimized gate charge minimizes switching loss

Pin Configuration

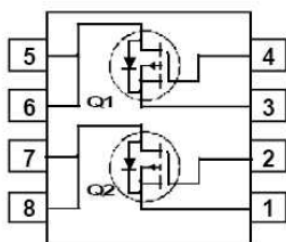

SOP-8

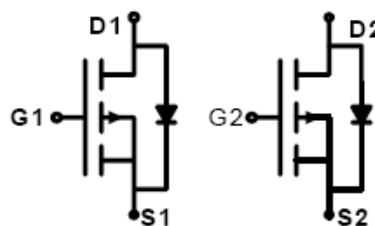

Schematic

Pin Descriptions

Pin Name	Symbol	Function
Gate(2,4)	G	Device Gate terminal
Drain(5,6,7,8)	D	Device drain terminal
Source(1,,3,)	S	Device source terminal

Absolute Maximum Ratings

Stress greater than those listed under “Absolute Maximum Ratings” may cause permanent damage to the device. These stress ratings only, and functional operation of the device at these or any conditions beyond those indicated under recommended Operating Conditions is not implied. Exposure to “Absolute Maximum Rating” for extended periods may affect device reliability. Use of standard ESD handling precautions is required.

Parameter	Symbol	Maximum	Units
Drain-Source Voltage	V_{DS}	-30	V
Gate-Source Voltage	V_{GS}	± 20	V
Continuous Drain Current	I_D	-6	A
Pulsed Drain Current (Note 1)	I_{DM}	-30	A
Power Dissipation $T_C=25^\circ\text{C}$	P_D	1.3	W
Junction and Storage Temperature Range	T_J, T_{STG}	-65 to 150	$^\circ\text{C}$

Thermal Characteristics

Parameter	Symbol	Typ.	Units
Maximum Junction-to-Ambient (Note2)	$R_{\theta JA}$	62.5	$^\circ\text{C/W}$

Electrical Specifications

Parameter	Symbol	Conditions	Min.	Typ.	Max.	Units
STATIC PARAMETERS						
Drain-Source Breakdown Voltage	BVD_{SS}	$I_D=-250\mu\text{A}, V_{GS}=0\text{V}$	-30	-34		V
Zero Gate Voltage Drain Current	I_{DSS}	$V_{DS}=-24\text{V}, V_{GS}=0\text{V}, T_J=25^\circ\text{C}$			-0.3	μA
Gate-Body leakage current	I_{GSS}	$V_{DS}=0\text{V}, V_{GS}=\pm 20\text{V}$			± 0.1	μA
Gate Threshold Voltage	$V_{GS(th)}$	$V_{DS}=V_{GS}, I_D=-250\mu\text{A}$	-1.2	-1.3	-2	V
Static Drain-Source On-Resistance	$R_{DS(on)}$	$V_{GS}=-10\text{V}, I_D=-6\text{A}$		52	65	m Ω
		$V_{GS}=-4.5\text{V}, I_D=-4\text{A}$		67	80	
Maximum Body-Diode Continuous Current	I_S				-1.3	A
Diode Forward Voltage	V_{SD}	$I_S=-1\text{A}, V_{GS}=0\text{V}$		-0.8	-1.2	V
Forward Transconductance	g_{FS}	$V_{DS}=-5\text{V}, I_D=-5\text{A}$		10		S
DYNAMIC PARAMETERS						
Input Capacitance	C_{iss}	$V_{GS}=0\text{V}, V_{DS}=-15\text{V}, f=1\text{MHz}$		530		pF
Output Capacitance	C_{oss}			140		pF
Reverse Transfer Capacitance	C_{rss}			70		pF
SWITCHING PARAMETERS						
Total Gate Charge	Q_g	$V_{GS}=-5\text{V}, V_{DD}=-15\text{V},$		10	15	nC

Gate Source Charge	Q_{gs}	$I_D = -5A$ (Note 3)		2.2		nC
Gate Drain Charge	Q_{gd}			2.0		nC
Turn-On Delay Time	$t_{D(on)}$	$I_D = -1A, V_{DD} = -15V,$ $V_{GEN} = -10V, R_L = 3.6\Omega$ $R_G = 6\Omega$ (Note 3)		8	15	ns
Turn-On Rise Time	t_r			15	25	ns
Turn-Off Delay Time	$t_{D(off)}$			15	25	ns
Turn-Off Fall Time	t_f			10	17	ns

Notes

1. Pulse width limited by max. junction temperature
2. Surface mounted on 1 in² copper pad of FR4 board, $t \leq 5$ sec; 180°C/W when mounted on min. copper pad.
3. Pulse Width $\leq 300\mu s$, Duty Cycle $\leq 2\%$

Typical Performance Characteristics

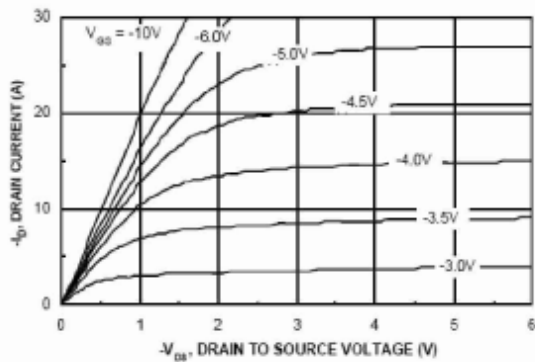

Figure 1. On-Region Characteristics.

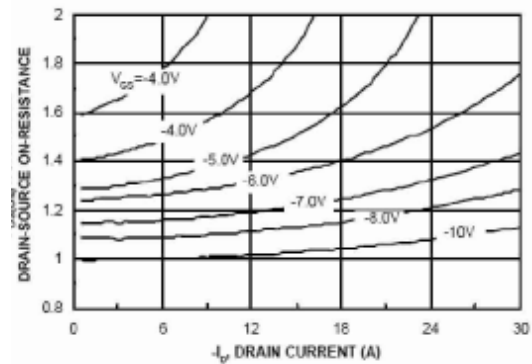

Figure 2. On-Resistance Variation with Drain Current and Gate Voltage.

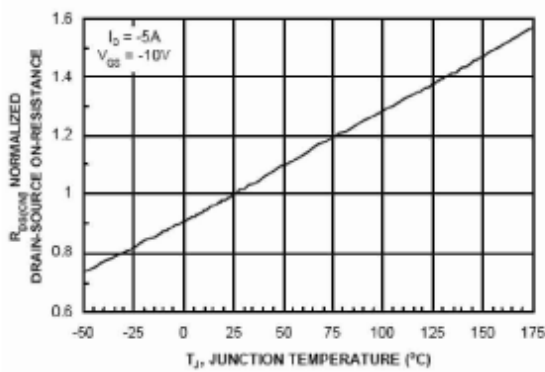

Figure 3. On-Resistance Variation with Temperature.

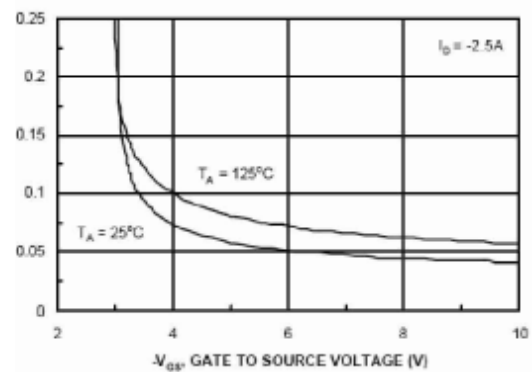

Figure 4. On-Resistance Variation with Gate-to-Source Voltage.

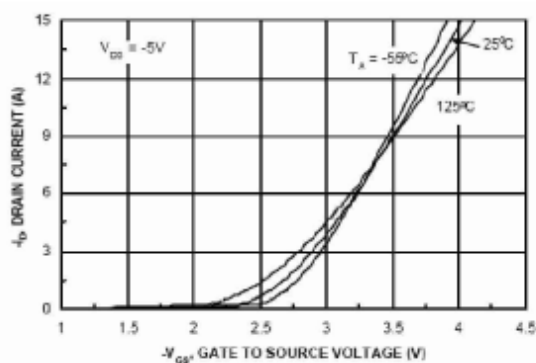

Figure 5. Transfer Characteristics.

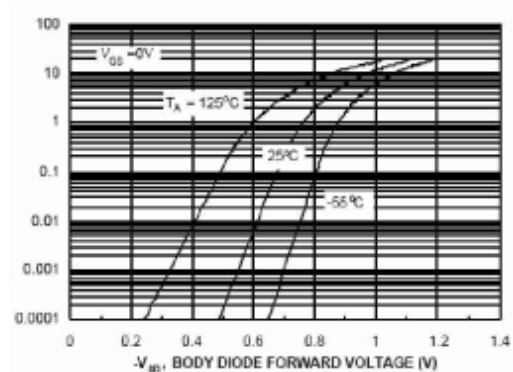

Figure 6. Body Diode Forward Voltage Variation with Source Current and Temperature.

Typical Performance Characteristics (contd.)

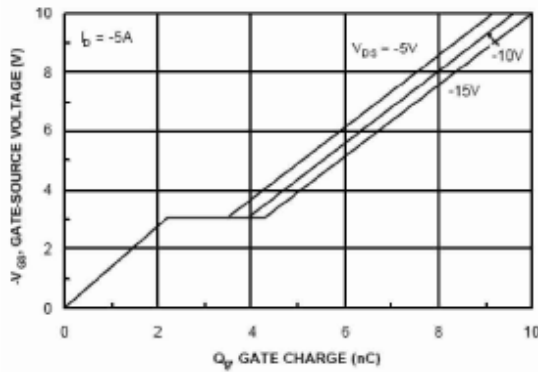

Figure 7. Gate Charge Characteristics.

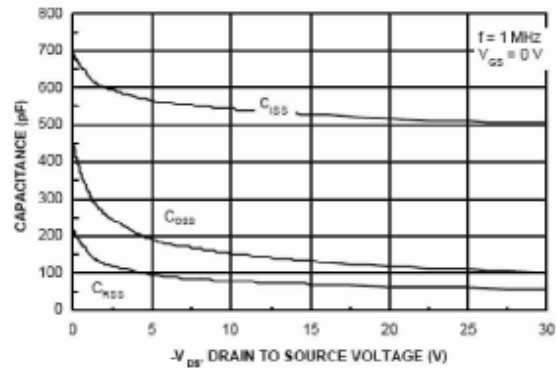

Figure 8. Capacitance Characteristics.

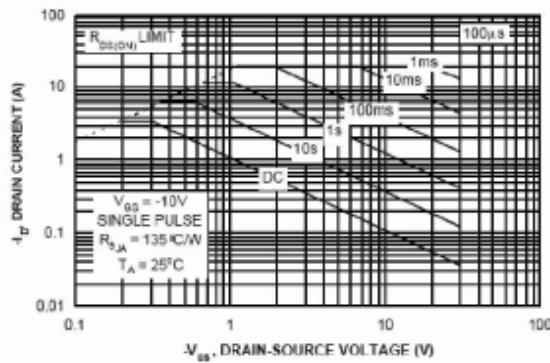

Figure 9. Maximum Safe Operating Area.

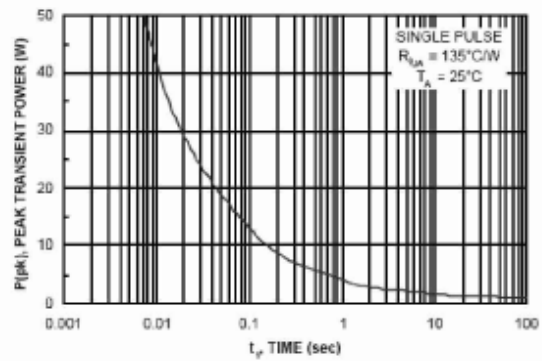

Figure 10. Single Pulse Maximum Power Dissipation.

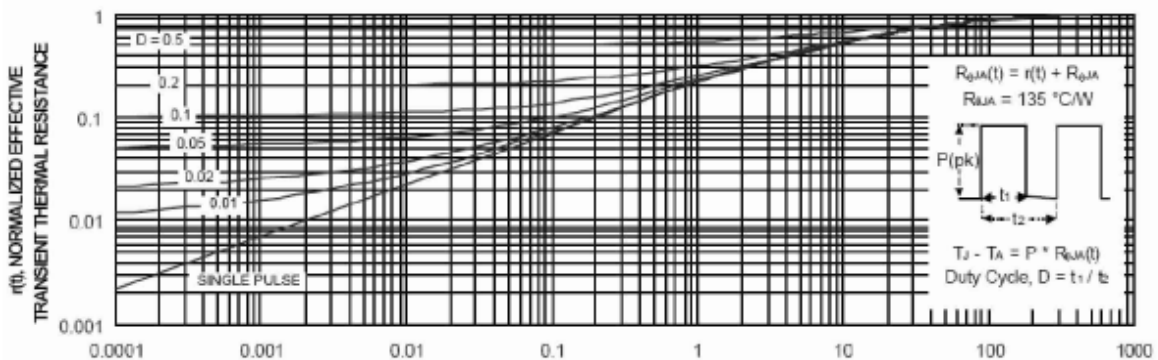
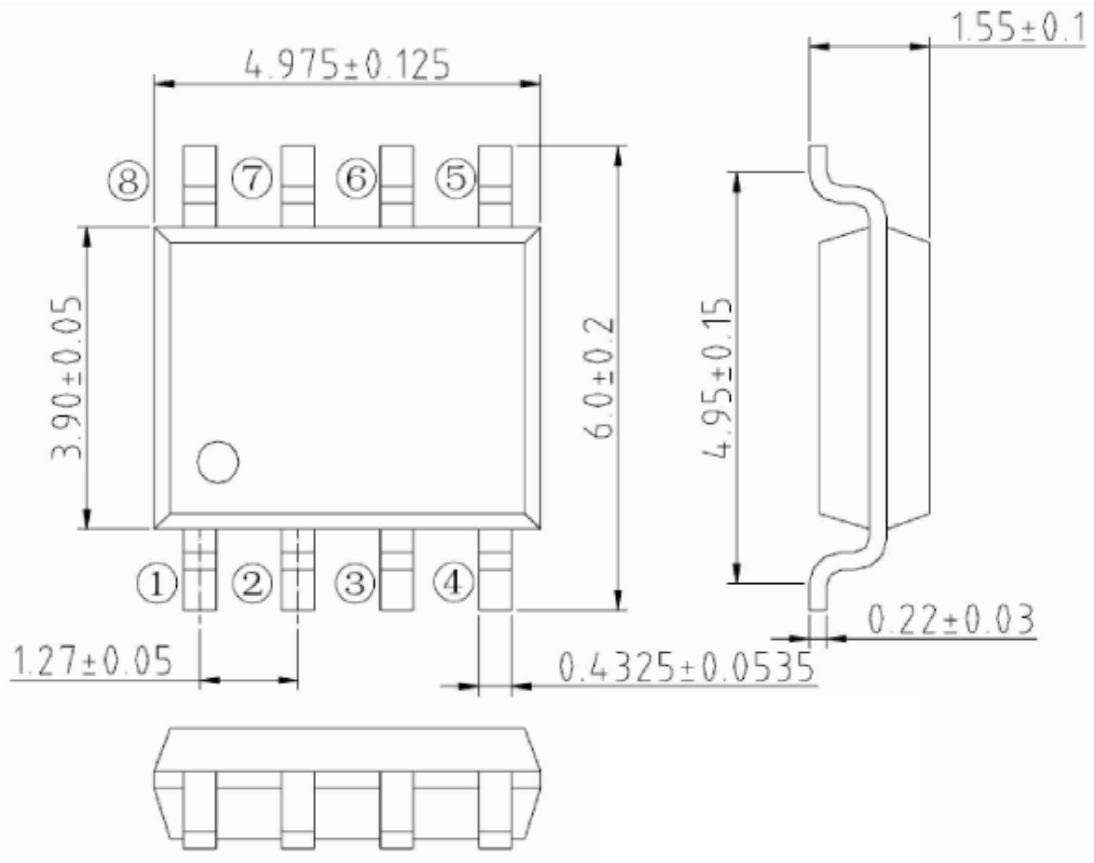

Figure 11. Transient Thermal Response Curve.

Thermal characterization performed using the conditions described in Note 1c. Transient thermal response will change depending on the circuit board design.



Package Dimensions
SOP-8



Ordering Information

Device	Operating T _j	PKG Type	Wrap	Order Number
PS4953A	-65C° ≤ 150C°	SOP-8	T&R	PS4953A-S8-TL

Note: Lead Free and RoHS compliant.

Warranty and Use

PROSPOWER MICROELECTRONICS MAKES NO WARRANTY, REPRESENTATION OR GUARANTEE, EXPRESS OR IMPLIED, REGARDING THE SUITABILITY OF ITS PRODUCTS FOR ANY PARTICULAR PURPOSE, NOR THAT THE USE OF ITS PRODUCTS WILL NOT INFRINGE ITS INTELLECTUAL PROPERTY RIGHTS OR THE RIGHTS OF THIRD PARTIES WITH RESPECT TO ANY PARTICULAR USE OR APPLICATION AND SPECIFICALLY DISCLAIMS ANY AND ALL LIABILITY ARISING OUT OF ANY SUCH USE OR APPLICATION, INCLUDING BUT NOT LIMITED TO, CONSEQUENTIAL OR INCIDENTAL DAMAGES.

ProsPower Microelectronics products are not designed, intended, or authorized for use as components in systems intended for surgical implant into the body, or other applications intended to support or sustain life, or for any other application in which the failure of the ProsPower Microelectronics product could create a situation where personal injury or death may occur.

ProsPower Microelectronics reserves the right to make changes to or discontinue any product or service described herein without notice. Products with data sheets labeled "Advance Information" or "Preliminary" and other products described herein may not be in production or offered for sale.

ProsPower Microelectronics advises customers to obtain the current version of the relevant product information before placing orders. Circuit diagrams illustrate typical semiconductor applications and may not be complete.