



ProsPower

PS04N20SA

20V Single Channel NMOSFET

Revision : 1.0
Update Date : Apr. 2011

ProsPower Microelectronics Co., Ltd

1. General Description

The PS04N20SA uses advanced trench technology and design to provide excellent $R_{ds(on)}$ with low gate charge. This device is suitable for use as a load switch or in PWM applications. Standard Product PS04N20SA is Pb-free (meets ROHS & Sony 259 specifications). It is offered in the very popular SOT23 package

2. Applications

- PWM applications
- Load switch
- Power management
- DC-DC convert

3. Features

- $V_{ds}=20V, I_d=4.2A$
- $R_{ds(on)}=29m\Omega (V_{gs}=4.5V)$
- $R_{ds(on)}=36m\Omega (V_{gs}=2.5V)$
- High Power and current handling capability
- Low capacitance minimizes driver loss
- Optimized gate charge minimizes switching loss

Pin Configuration

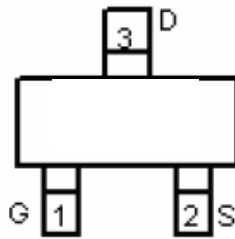

SOT23

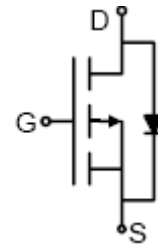

Schematic

Pin Descriptions

Pin Name	Symbol	Function
Gate(1)	G	Device Gate terminal
Drain(3)	D	Device drain terminal
Source(2)	S	Device source terminal

Absolute Maximum Ratings

Stress greater than those listed under “Absolute Maximum Ratings” may cause permanent damage to the device. These stress ratings only, and functional operation of the device at these or any conditions beyond those indicated under recommended Operating Conditions is not implied. Exposure to “Absolute Maximum Rating” for extended periods may affect device reliability. Use of standard ESD handling precautions is required..

Parameter	Symbol	Maximum	Units
Drain-Source Voltage	V_{DS}	20	V
Gate-Source Voltage	V_{GS}	± 8	V
Continuous Drain Current	I_D	4.2	A
Junction Temperature	T_J	150	$^{\circ}C$
Power Dissipation $T_C=25^{\circ}C$	P_D	1.4	W
Storage Temperature Range	T_{STG}	-65 to 150	$^{\circ}C$

Electrical Specifications

Parameter	Symbol	Conditions	Min.	Typ.	Max.	Units
STATIC PARAMETERS						
Drain-Source Breakdown Voltage	BVD_{SS}	$I_D=250\mu A, V_{GS}=0V$	20	23		V
Zero Gate Voltage Drain Current	I_{DSS}	$V_{DS}=20V, V_{GS}=0V, T_J=25^{\circ}C$			1	μA
Gate-Body leakage current	I_{GSS}	$V_{DS}=0V, V_{GS}=\pm 8V$			± 0.1	μA
Gate Threshold Voltage	$V_{GS(th)}$	$V_{DS}=V_{GS}, I_D=250\mu A$	0.51	0.53	0.85	V
Static Drain-Source On-Resistance	$R_{DS(on)}$	$V_{GS}=4.5V, I_D=3A$		29	50	m Ω
		$V_{GS}=2.5V, I_D=2A$		36	65	
Forward Transconductance	g_{FS}	$V_{DS}=5V, I_D=3.6A$		8		S
Diode Forward Voltage	V_{SD}	$I_S=1.25A, V_{GS}=0V$	0.4	0.7	1	V
DYNAMIC PARAMETERS						
Input Capacitance	C_{iss}	$V_{GS}=0V, V_{DS}=10V, f=1MHz$		300		pF
Output Capacitance	C_{oss}			120		pF
Reverse Transfer Capacitance	C_{rss}			80		pF
SWITCHING PARAMETERS						
Total Gate Charge	Q_g	$V_{GS}=4.5V, V_{DD}=10V, I_D=3.6A$ (Note 3)		4	10	nC
Gate Source Charge	Q_{gs}			0.65		nC
Gate Drain Charge	Q_{gd}			1.5		nC
Turn-On Delay Time	$t_{D(on)}$	$I_D=3.6A, V_{DD}=10V,$		8	15	ns

Turn-On Rise Time	t_r	$V_{GEN}=4.5V, R_L=2.8\Omega$ $R_G=6\Omega$ (Note 3)		50	80	ns
Turn-Off Delay Time	$t_{D(off)}$			15	60	ns
Turn-Off Fall Time	t_f			10	25	ns

Notes

1. Pulse width limited by max. junction temperature
2. Surface mounted on 1 in² copper pad of FR4 board, $t \leq 5\text{sec}$; 180°C/W when mounted on min. copper pad.
3. Pulse Width $\leq 300\mu\text{s}$, Duty Cycle $\leq 2\%$

Typical Performance Characteristics

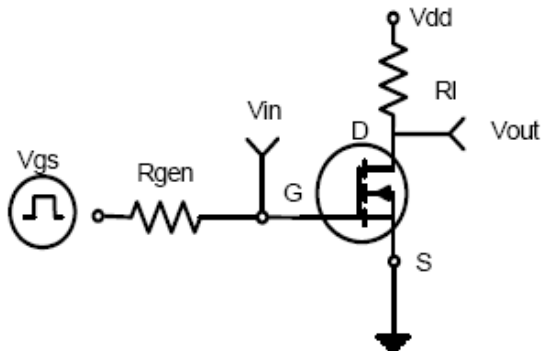

Figure 1: Switching Test Circuit

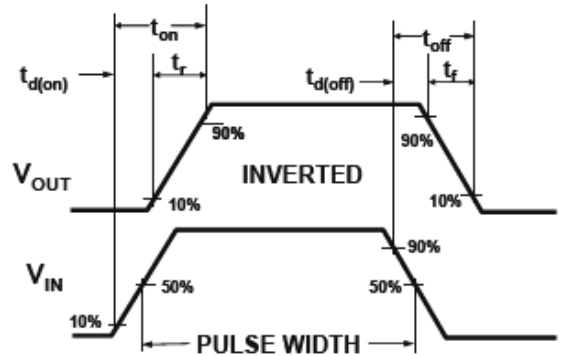

Figure 2: Switching Waveforms

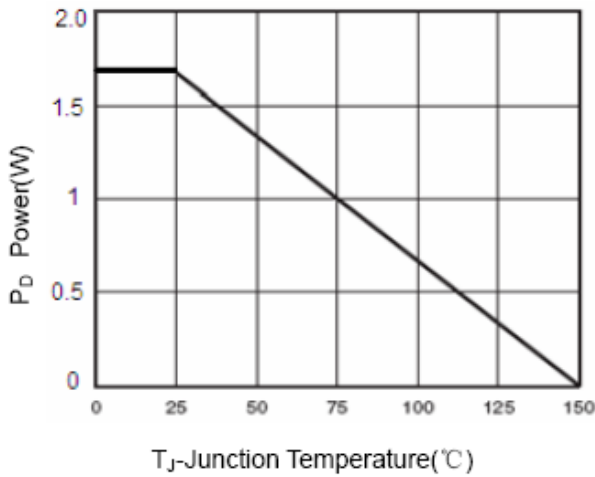

Figure 3 Power Dissipation

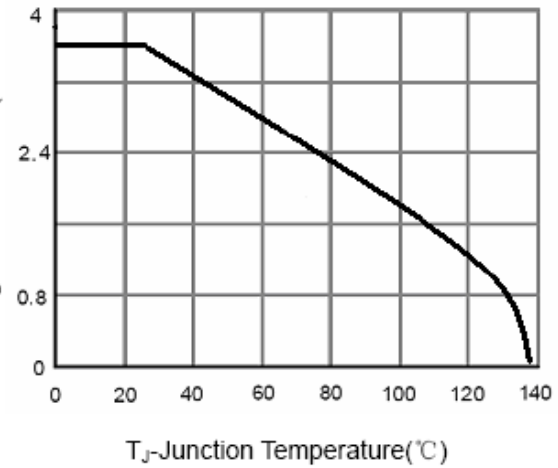

Figure 4 Drain Current

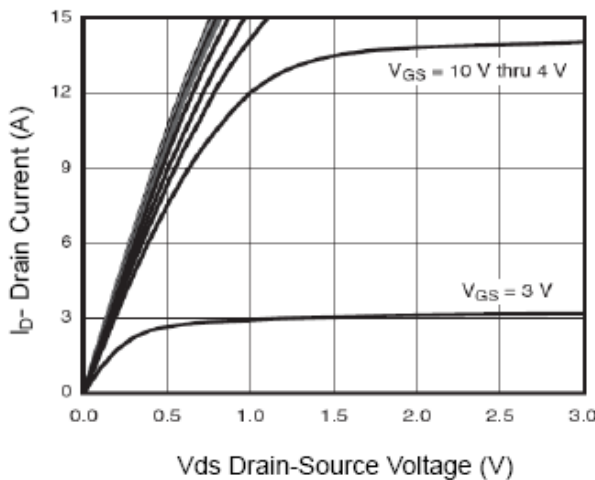

Figure 5 Output CHARACTERISTICS

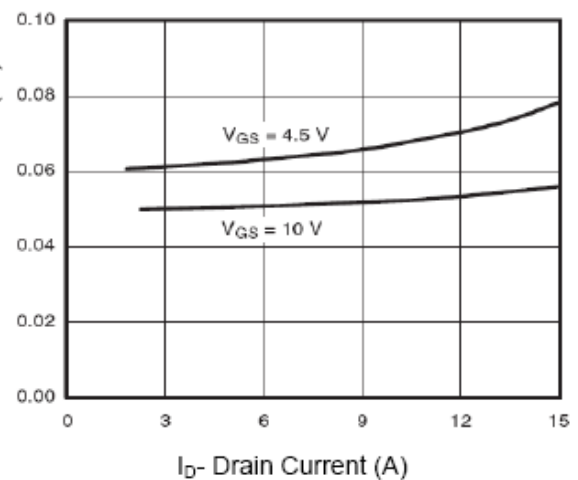

Figure 6 Drain-Source On-Resistance

Typical Performance Characteristics (contd.)

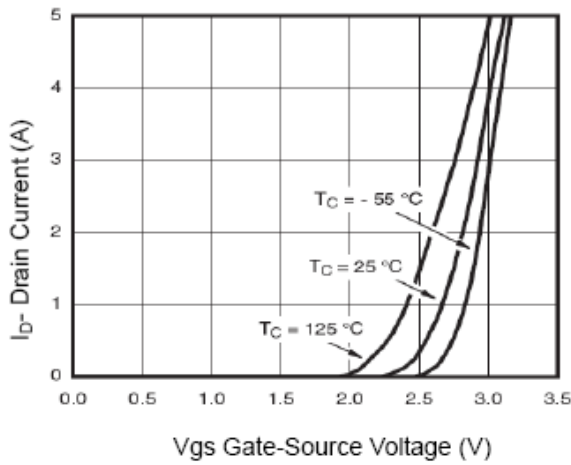

Figure 7 Transfer Characteristics

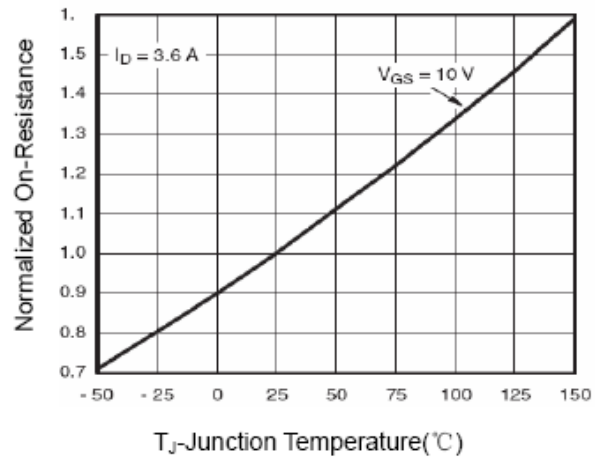

Figure 8 Drain-Source On-Resistance

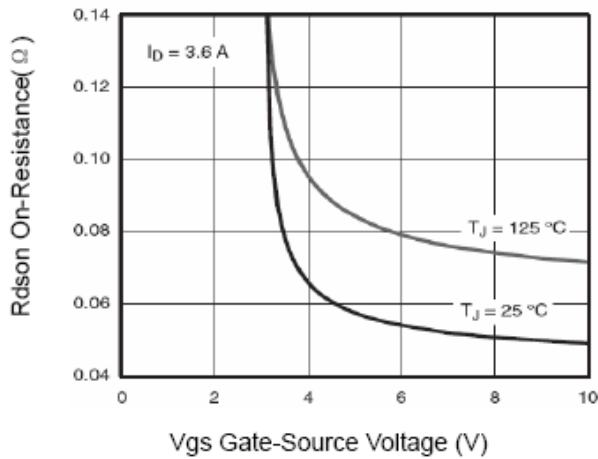

Figure 9 $R_{DS(on)}$ vs V_{GS}

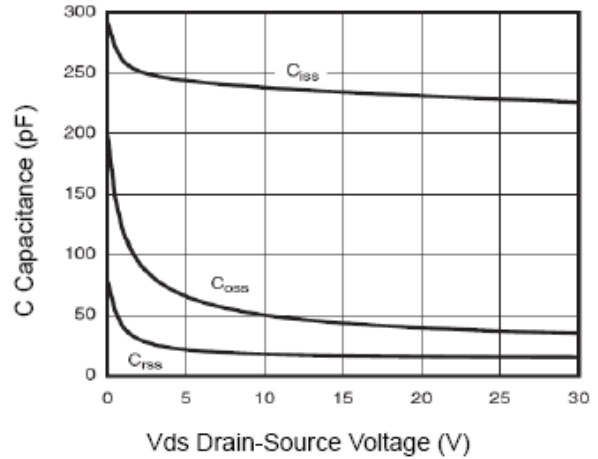

Figure 10 Capacitance vs V_{DS}

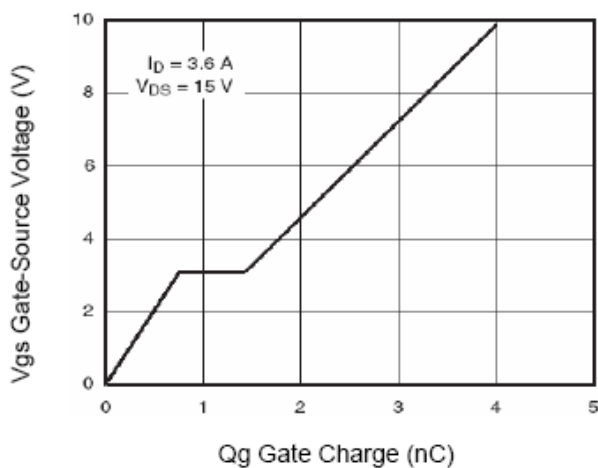

Figure 11 Gate Charge

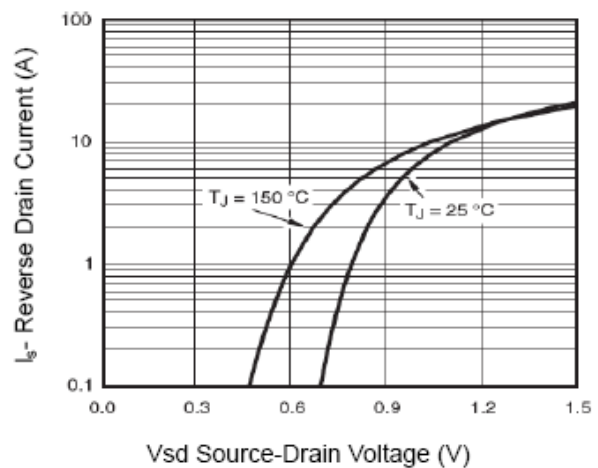

Figure 12 Source-Drain Diode Forward

Typical Performance Characteristics (contd.)

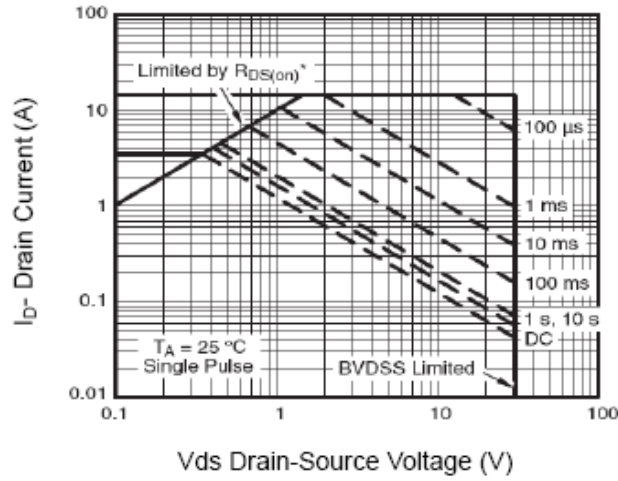

Figure 13 Safe Operation Area

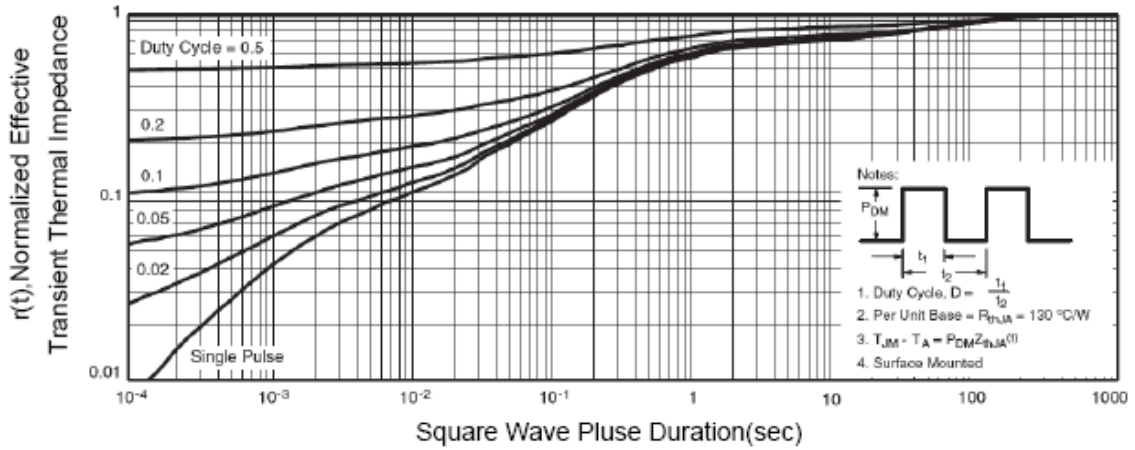
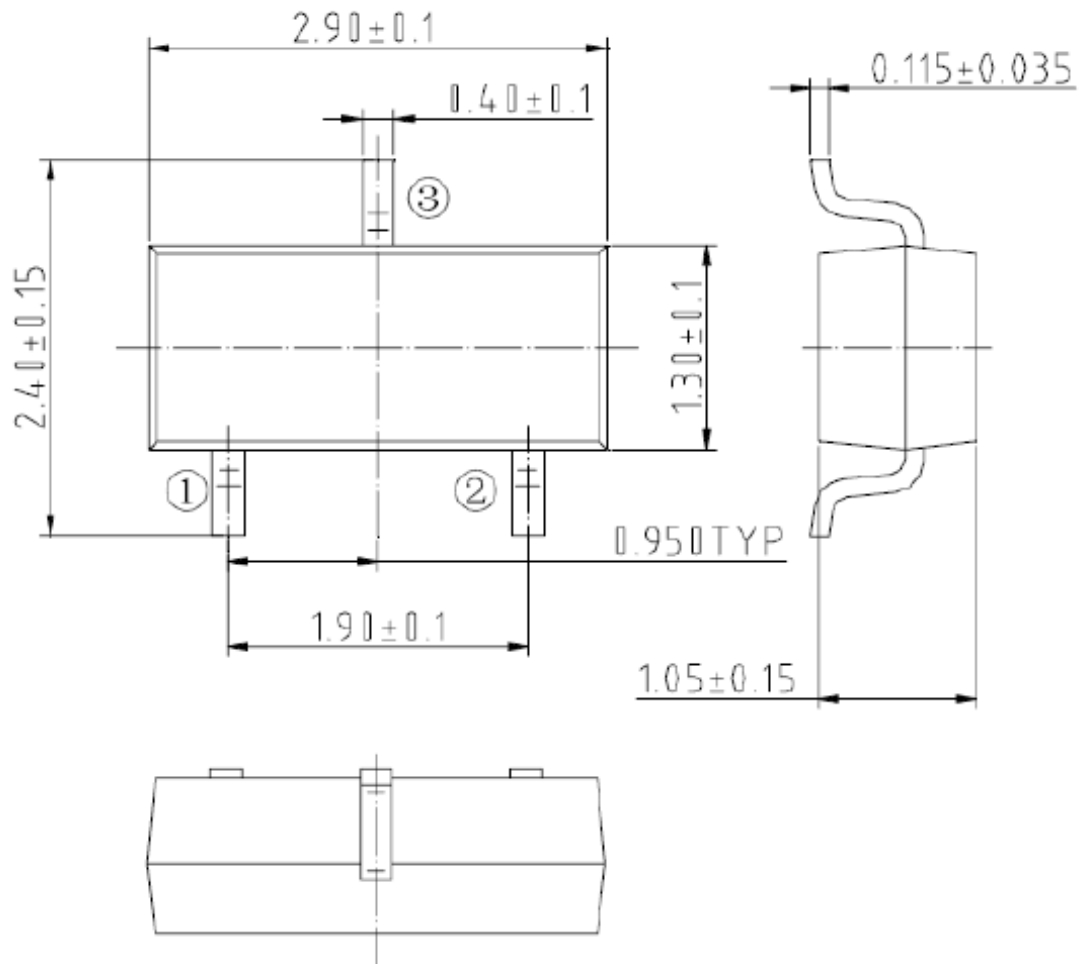

Figure 14 Normalized Maximum Transient Thermal Impedance

Package Dimensions
SOT23



Ordering Information

Device	Operating T _j	PKG Type	Wrap	Order Number
PS04N20SA	-65C° ≤ 150C°	SOT23	T&R	PS04N20SA-S2-TL

Note: Lead Free and RoHS compliant.

Warranty and Use

PROSPower MICROELECTRONICS MAKES NO WARRANTY, REPRESENTATION OR GUARANTEE, EXPRESS OR IMPLIED, REGARDING THE SUITABILITY OF ITS PRODUCTS FOR ANY PARTICULAR PURPOSE, NOR THAT THE USE OF ITS PRODUCTS WILL NOT INFRINGE ITS INTELLECTUAL PROPERTY RIGHTS OR THE RIGHTS OF THIRD PARTIES WITH RESPECT TO ANY PARTICULAR USE OR APPLICATION AND SPECIFICALLY DISCLAIMS ANY AND ALL LIABILITY ARISING OUT OF ANY SUCH USE OR APPLICATION, INCLUDING BUT NOT LIMITED TO, CONSEQUENTIAL OR INCIDENTAL DAMAGES.

ProsPower Microelectronics products are not designed, intended, or authorized for use as components in systems intended for surgical implant into the body, or other applications intended to support or sustain life, or for any other application in which the failure of the ProsPower Microelectronics product could create a situation where personal injury or death may occur.

ProsPower Microelectronics reserves the right to make changes to or discontinue any product or service described herein without notice. Products with data sheets labeled "Advance Information" or "Preliminary" and other products described herein may not be in production or offered for sale.

ProsPower Microelectronics advises customers to obtain the current version of the relevant product information before placing orders. Circuit diagrams illustrate typical semiconductor applications and may not be complete.