

GSTMMBT5401

High Voltage PNP Transistors

Product Description

This device is designed as a general purpose amplifier and switch.

Features

- Collector-Emitter Voltage : -150V
- Collector-Base Voltage : -160V
- Collector Current-Continuous : -500mA
- Lead(Pb)-Free

Packages & Pin Assignments

GSTMMBT5401F(SOT-23)	
	
Pin	Description
1	Base
2	Emitter
3	Collector

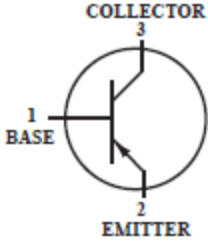

Marking Information

P/N	Package	Part Marking
GSTMMBT5401F	SOT-23	2L

Ordering Information

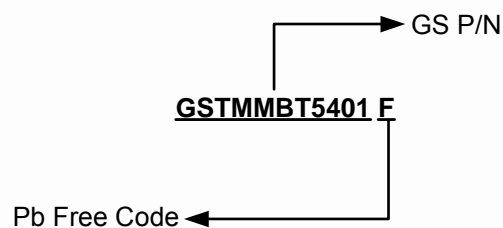

Part Number	Package	Quantity
GSTMMBT5401F	SOT-23	3000 PCS

Absolute Maximum Ratings

T_A=25°C

Symbol	Conditions	Value	Unit
V _{CEO}	Collector-Emitter Voltage	-150	V
V _{CBO}	Collector-Base Voltage	-160	V
V _{EBO}	Emitter-Base Voltage	-5.0	V
I _{C(DC)}	Collector Current (DC)	-500	mA
P _D	Total Device Dissipation FR-5 Board ⁽¹⁾ T _A =25°C	225	mW
	Derate above 25°C	1.8	mW/°C
R _{θJA}	Thermal Resistance Junction to Ambient	556	°C/W
P _D	Total Device Dissipation Alumina Substrate ⁽²⁾ T _A =25°C	300	mW
	Derate above 25°C	2.4	mW/°C
R _{θJA}	Thermal Resistance Junction to Ambient	417	°C/W
T _J	Junction Temperature Range	-55 to +150	°C
T _{STG}	Storage Temperature Range	-55 to +150	°C

Note 1: FR-5=1.0 x 0.75 x 0.062 in

Note 2: Alumina=0.4 x 0.3 x 0.024 in. 99.5% alumina.

Electrical Characteristics

(T_A=25°C unless otherwise noted)

Symbol	Conditions	Min	Max	Unit
V _{(BR)CEO}	Collector-Emitter Breakdown Voltage ⁽³⁾ (I _C =-1.0mA, I _B =0mA)	-150	-	V
V _{(BR)CBO}	Collector-Base Breakdown Voltage (I _C =-100uA, I _E =0mA)	-160	-	V
V _{(BR)EBO}	Emitter-Base Breakdown Voltage (I _E =-10uA, I _C =0mA)	-5.0	-	V
I _{CES}	Collector Cutoff Current (V _{CE} =-120V, I _E =0mA)	-	-50	uA
h _{FE}	DC Current Gain (I _C =-1.0mA, V _{CE} =-5.0V)	50	-	-
	DC Current Gain (I _C =-10mA, V _{CE} =-5.0V)	60	240	-
	DC Current Gain (I _C =-50mA, V _{CE} =-5.0V)	50	-	-
V _{CE(sat)}	Collector-Emitter Saturation Voltage (I _C =-10mA, I _B =-1.0mA)	-	-0.2	V
	(I _C =-50mA, I _B =-5.0mA)	-	-0.5	
V _{BE(sat)}	Base-Emitter Saturation Voltage (I _C =-10mA, I _B =-1.0mA)	-	-1.0	V
	(I _C =-50mA, I _B =-5.0mA)	-	-1.0	
f _T	Current-Gain-Bandwidth Product ⁽⁴⁾ (I _C =-10mA, V _{CE} =-10V, f=100MHz)	100	300	MHz
C _{obo}	Output Capacitance (V _{CB} =-10V, I _E =0mA, f=1.0MHz)	-	6.0	pF
h _{fe}	Small-Signal Current Gain (I _C =-1.0mA, V _{CE} =-10V, f=1.0 kHz)	40	200	-
NF	Noise Figure (I _C =-200uA, V _{CE} =-5V, R _S =10Ω, f=1.0kHz)	-	8.0	dB

Typical Performance Characteristics

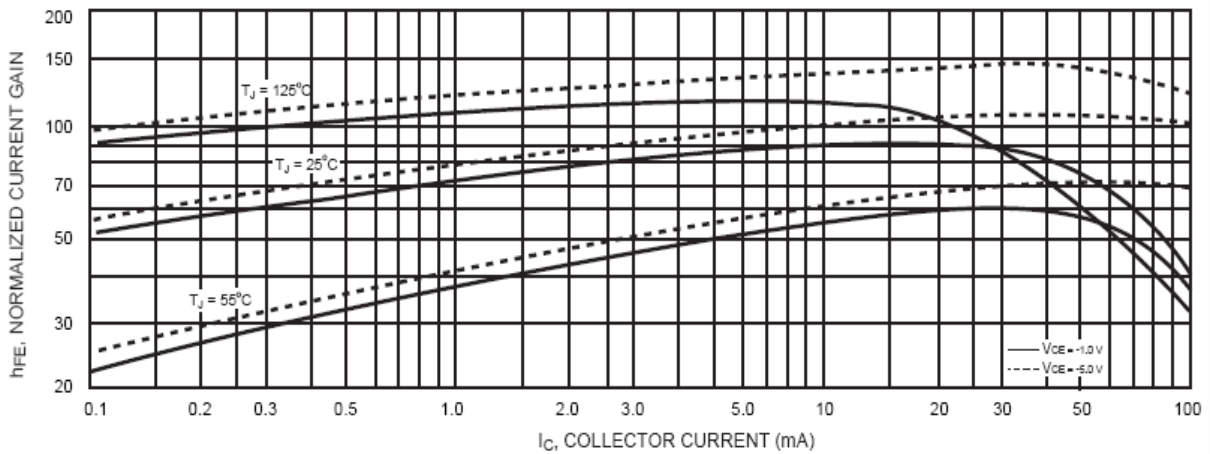

FIG.1 DC Current Gain

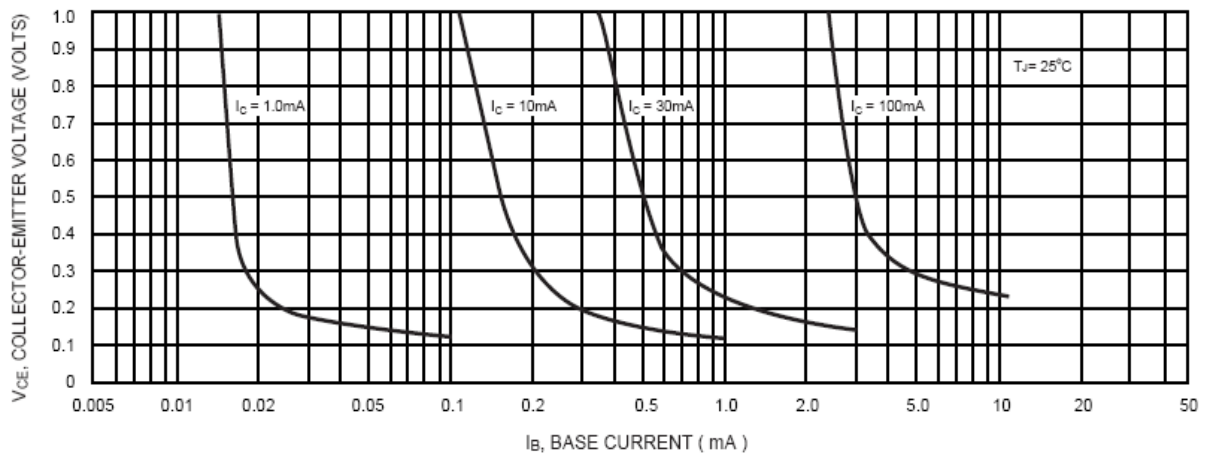

FIG.2 Collector Saturation Region

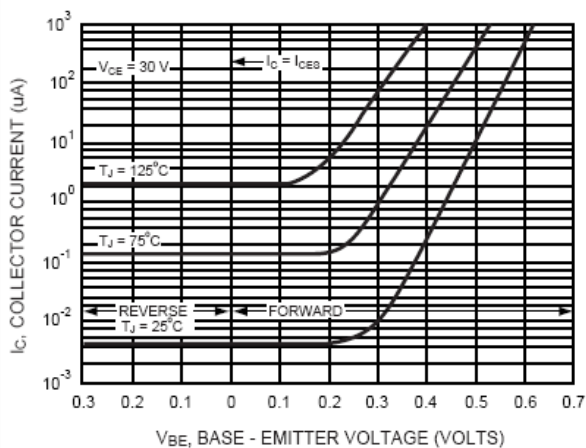

FIG.3 Temperature Coefficients

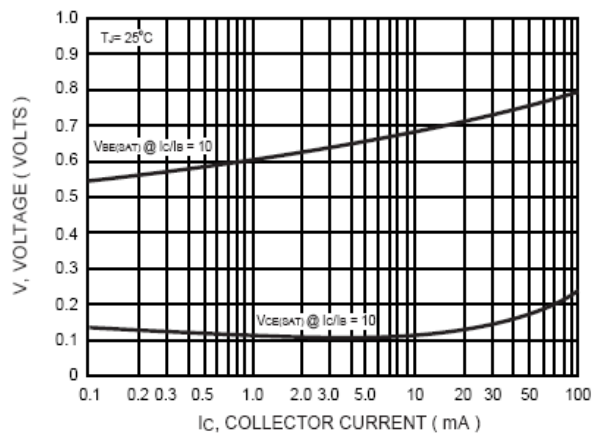

FIG.4 "On" Voltages

Typical Performance Characteristics (Continue)

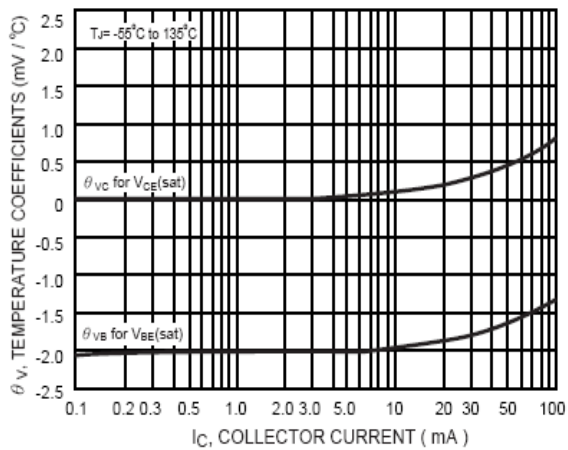
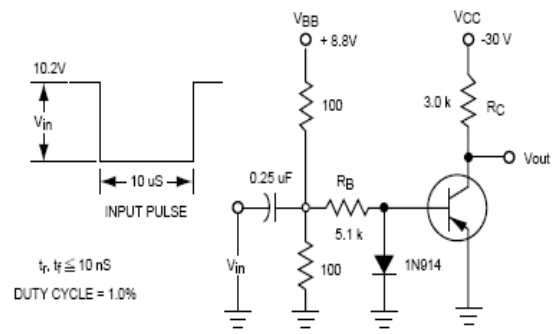

FIG.5 Temperature Coefficients



VALUES SHOWN ARE FOR $I_C @ 10 \text{ mA}$

FIG.6 Switching Time Test Circuit

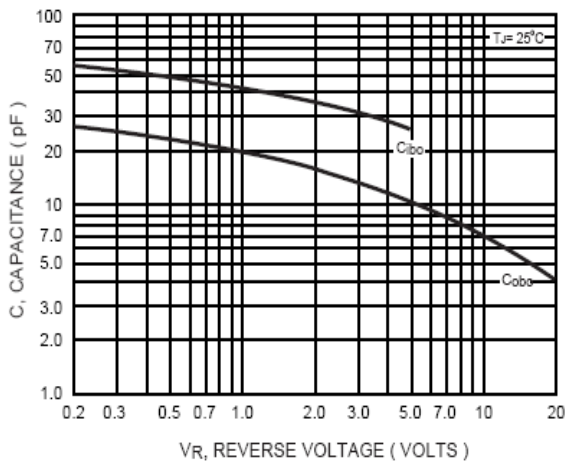

FIG.7 Capacitances

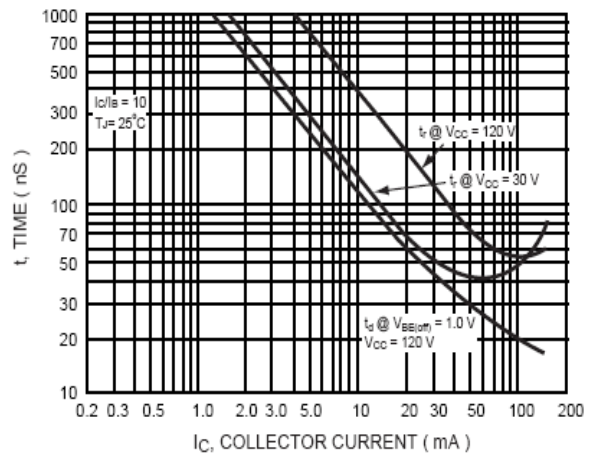

FIG.8 Turn - On Time

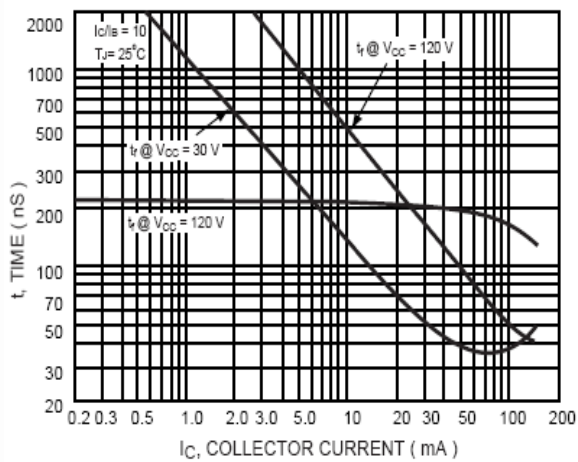
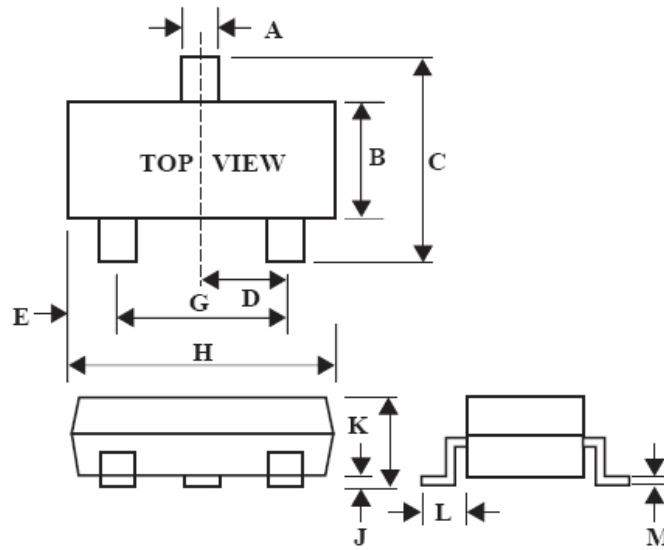

FIG.9 Turn - Off Time

Package Dimension

SOT-23



Dimensions				
Symbol	Millimeters		Inches	
	Min	Max	Min	Max
A	0.35	0.51	0.014	0.020
B	1.19	1.40	0.047	0.055
C	2.10	3.00	0.083	0.118
D	0.85	1.05	0.033	0.041
E	0.46	1.00	0.018	0.039
G	1.70	2.10	0.067	0.083
H	2.70	3.10	0.106	0.122
J	0.01	0.13	0.000	0.005
K	0.89	1.10	0.035	0.043
L	0.30	0.61	0.011	0.024
M	0.076	0.25	0.002	0.010

NOTICE

Information furnished is believed to be accurate and reliable. However Globaltech Semiconductor assumes no responsibility for the consequences of use of such information nor for any infringement of patents or other rights of third parties, which may result from its use. No license is granted by implication or otherwise under any patent or patent rights of Globaltech Semiconductor. Specifications mentioned in this publication are subject to change without notice. This publication supersedes and replaces all information without express written approval of Globaltech Semiconductor.

CONTACT US

GS Headquarter	
	4F.,No.43-1,Lane11,Sec.6,Minquan E.Rd NeiHu District Taipei City 114, Taiwan (R.O.C)
	886-2-2657-9980
	886-2-2657-3630
	sales_twn@gs-power.com

Wu-Xi Branch	
	No.21 Changjiang Rd., WND, Wuxi, Jiangsu, China (INFO. & TECH. Science Park Building A 210 Room)
	86-510-85217051
	86-510-85211238
	sales_cn@gs-power.com

RD Division	
	824 Bolton Drive Milpitas. CA. 95035
	1-408-457-0587