

GSTMMBT2907A

PNP General Purpose Transistor

Product Description

This device is designed as a general purpose amplifier and switch.

Features

- Lead(Pb)-Free

Packages & Pin Assignments

GSTMMBT2907AF(SOT-23)	
	
Pin	Description
1	Base
2	Emitter
3	Collector

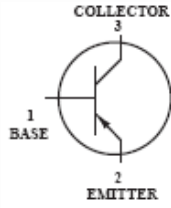

Marking Information

P/N	Package	Part Marking
GSTMMBT2907AF	SOT-23	2F

Ordering Information

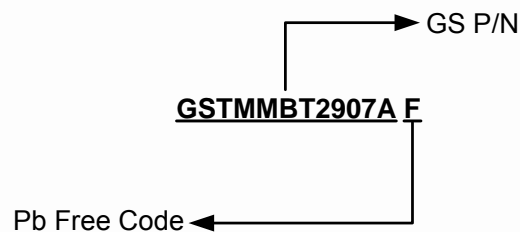

Part Number	Package	Quantity
GSTMMBT2907AF	SOT-23	3000 PCS

Absolute Maximum Ratings

$T_A=25^\circ\text{C}$

Symbol	Conditions	Typical	Unit
V_{CEO}	Collector-Emitter Voltage	-60	V
V_{CBO}	Collector-Base Voltage	-60	V
V_{EBO}	Emitter-Base Voltage	-5.0	V
I_C	Collector Current-Continuous	-600	mA
P_D	Total Device Dissipation FR-5 Board (1) $T_A=25^\circ\text{C}$	225	mW
	Derate above 25°C	1.8	mW/ $^\circ\text{C}$
$R_{\theta JA}$	Thermal Resistance Junction to Ambient	556	$^\circ\text{C}/\text{W}$
P_D	Total Device Dissipation Alumina Substrate (2) $T_A=25^\circ\text{C}$	300	mW
	Derate above 25°C	2.4	mW/ $^\circ\text{C}$
$R_{\theta JA}$	Thermal Resistance Junction to Ambient	417	$^\circ\text{C}/\text{W}$
T_J	Junction Temperature Range	-55 to +150	$^\circ\text{C}$
T_{STG}	Storage Temperature Range	-55 to +150	$^\circ\text{C}$

Note 1: FR-5=1.0 x 0.75 x 0.062 in

Note 2: Alumina=0.4 x 0.3 x 0.024in, 99.5% alumina

Electrical Characteristics

($T_A=25^\circ\text{C}$ unless otherwise noted)

Symbol	Conditions	Min	Max	Unit
$V_{(BR)CEO}$	Collector-Emitter Breakdown Voltage ($I_C=-10\text{mA}$, $I_B=0\text{mA}$)	-60	-	V
$V_{(BR)CBO}$	Collector-Base Breakdown Voltage ($I_C=-10\mu\text{A}$, $I_E=0\text{mA}$)	-60	-	V
$V_{(BR)EBO}$	Emitter-Base Breakdown Voltage ($I_E=-10\mu\text{A}$, $I_C=0\text{mA}$)	-5.0	-	V
I_{CEX}	Collector Cutoff Current ($V_{CE}=-30\text{V}$, $V_{EB(off)}=-0.5\text{V}$)	-	-50	nA
I_{CBO}	Collector Cutoff Current ($V_{CB}=-50\text{V}$, $I_E=0\text{mA}$)	-	-0.01	nA
	($V_{CB}=-50\text{V}$, $I_E=0\text{mA}$, $T_A=125^\circ\text{C}$)	-	-10	nA
I_B	Base Cutoff Current ($V_{CE}=-30\text{V}$, $V_{EB(off)}=-0.5\text{V}$)	-	-50	nA
h_{FE}	DC Current Gain ($I_C=-0.1\text{mA}$, $V_{CE}=-10\text{V}$)	75	-	-
	DC Current Gain ($I_C=-1.0\text{mA}$, $V_{CE}=-10\text{V}$)	100	-	-
	DC Current Gain ($I_C=-10\text{mA}$, $V_{CE}=-10\text{V}$)	100	-	-
	DC Current Gain ($I_C=-150\text{mA}$, $V_{CE}=-10\text{V}$)	100	300	-
	DC Current Gain ($I_C=-500\text{mA}$, $V_{CE}=-10\text{V}$)	50	-	-

Electrical Characteristics (Continue)

($T_A=25^\circ\text{C}$ unless otherwise noted)

Symbol	Conditions	Min	Max	Unit
$V_{CE(sat)}$	Collector-Emitter Saturation Voltage (3) ($I_C=-150\text{mA}$, $I_B=-15\text{mA}$) ($I_C=-500\text{mA}$, $I_B=-50\text{mA}$)	- -	-0.4 -1.6	V
$V_{BE(sat)}$	Base-Emitter Saturation Voltage (3) ($I_C=-150\text{mA}$, $I_B=-15\text{mA}$) ($I_C=-500\text{mA}$, $I_B=-50\text{mA}$)	- -	-1.3 -2.6	V
f_T	Current-Gain-Bandwidth Product (4) ($I_C=-50\text{mA}$, $V_{CE}=-20\text{V}$, $f=100\text{MHz}$)	200	-	MHz
C_{obo}	Output Capacitance ($V_{CB}=-10\text{V}$, $I_E=0\text{mA}$, $f=1.0\text{MHz}$)	-	8.0	pF
C_{ibo}	Input Capacitance ($V_{EB}=-2.0\text{V}$, $I_C=0\text{mA}$, $f=1.0\text{MHz}$)	-	30	pF
t_{on}	Turn-On Time ($V_{CC}=-30\text{V}$, $I_C=-150\text{mA}$, $I_{B1}=-15\text{mA}$)	-	45	ns
t_d	Delay Time ($V_{CC}=-30\text{V}$, $I_C=-150\text{mA}$, $I_{B1}=-15\text{mA}$)	-	10	ns
t_r	Rise Time ($V_{CC}=-30\text{V}$, $I_C=-150\text{mA}$, $I_{B1}=-15\text{mA}$)	-	40	ns
t_{off}	Turn-Off Time ($V_{CC}=-60\text{V}$, $I_C=-150\text{mA}$, $I_{B1}=I_{B2}=-15\text{mA}$)	-	100	ns
t_s	Storage Time ($V_{CC}=-60\text{V}$, $I_C=-150\text{mA}$, $I_{B1}=I_{B2}=-15\text{mA}$)	-	80	ns
t_f	Fall Time ($V_{CC}=-60\text{V}$, $I_C=-150\text{mA}$, $I_{B1}=I_{B2}=-15\text{mA}$)	-	30	ns

Note 3: Pulse Test: Pulse Width ≤ 300 us, Duty Cycle $\leq 2.0\%$

Note 4: f_T is defined as the frequency at which h_{fe} extrapolates to unity

Typical Application Circuit

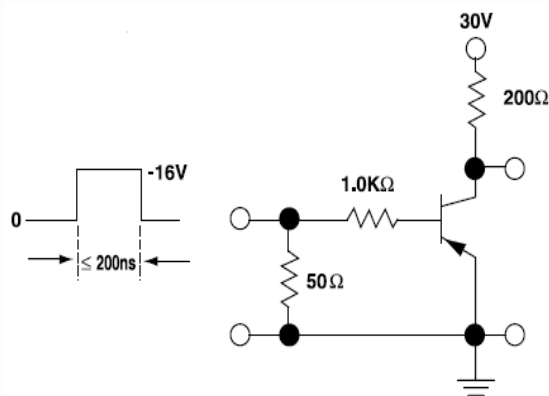

FIG.11 Saturated Turn-On Switching Time

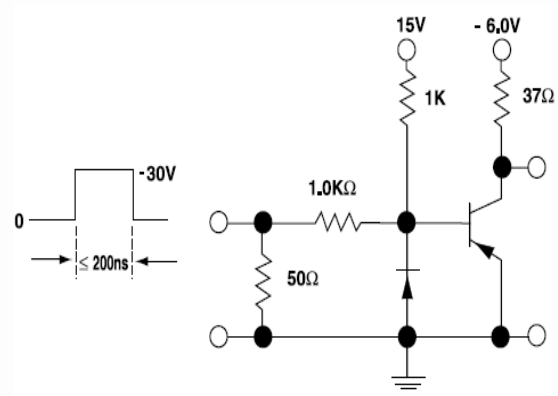

FIG.12 Saturated Turn-Off Switching Time

Typical Performance Characteristics

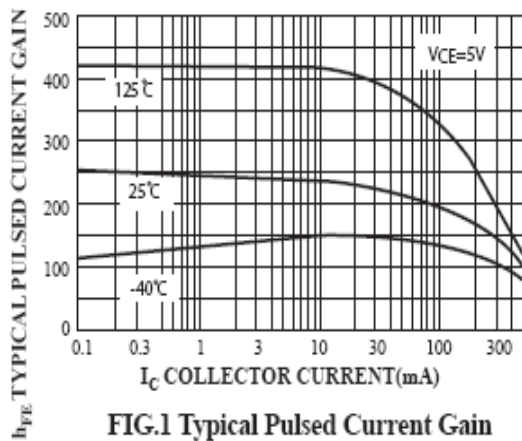

FIG.1 Typical Pulsed Current Gain vs Collector Current

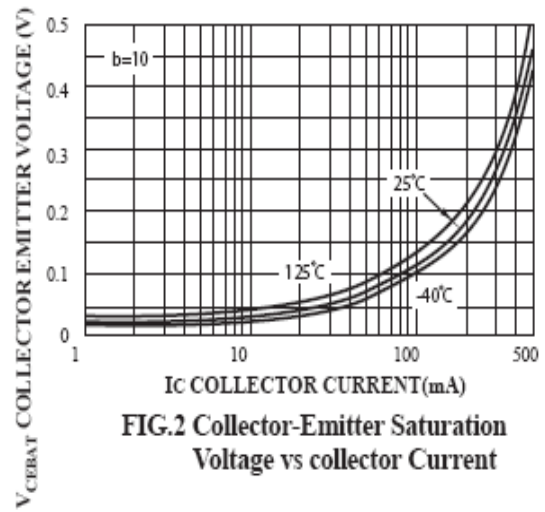

FIG.2 Collector-Emitter Saturation Voltage vs collector Current

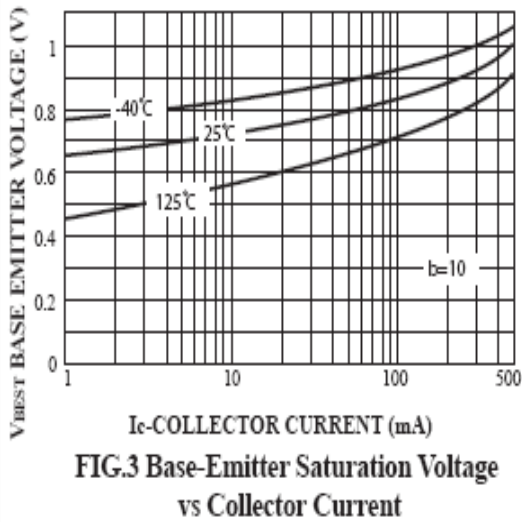

FIG.3 Base-Emitter Saturation Voltage vs Collector Current

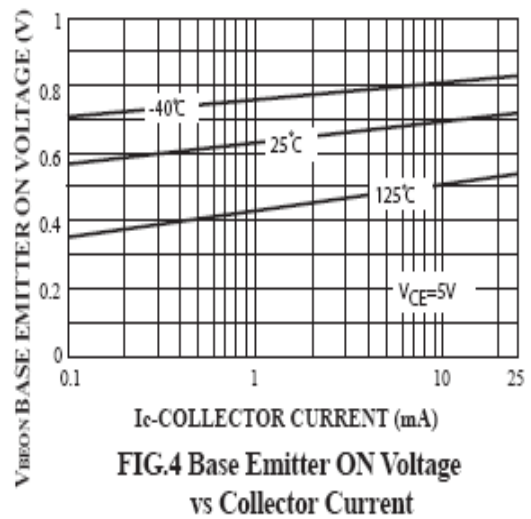

FIG.4 Base Emitter ON Voltage vs Collector Current

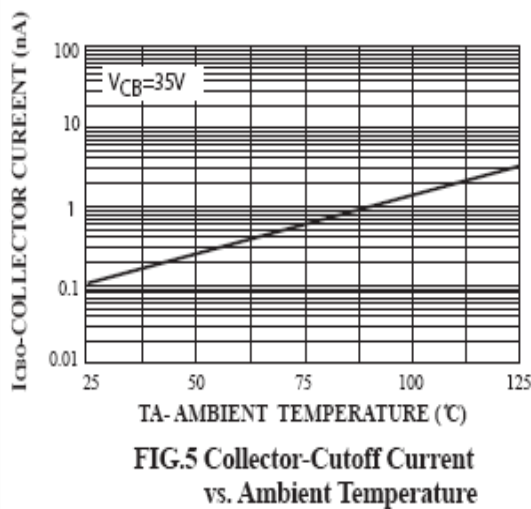

FIG.5 Collector-Cutoff Current vs. Ambient Temperature

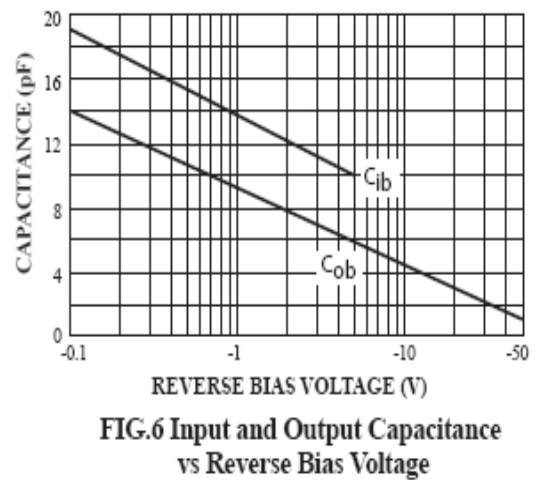

FIG.6 Input and Output Capacitance vs Reverse Bias Voltage

Typical Performance Characteristics (Continue)

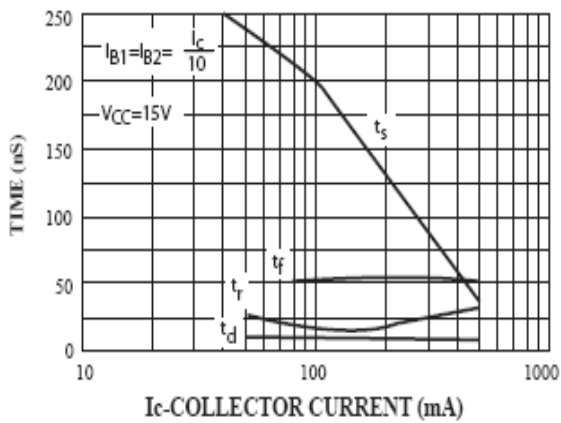

FIG.7 Switching Times vs Collector Current

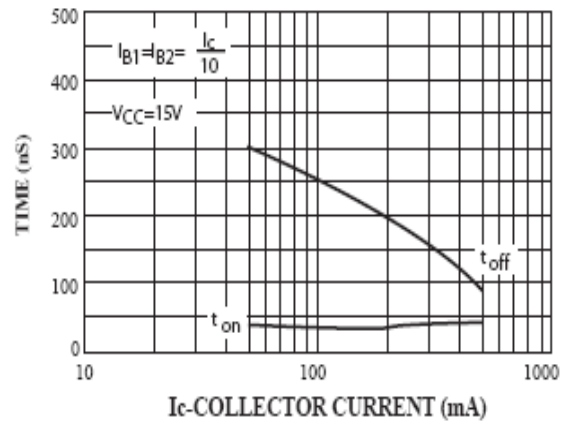

FIG.8 Turn On and Turn Off Times vs Collector Current

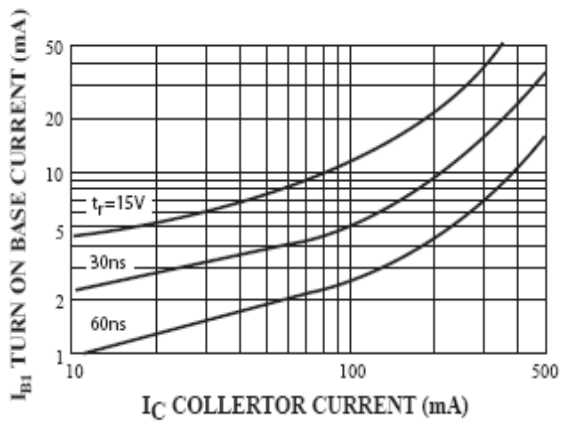

FIG.9 Rise Time vs Collector and Turn On Base Current

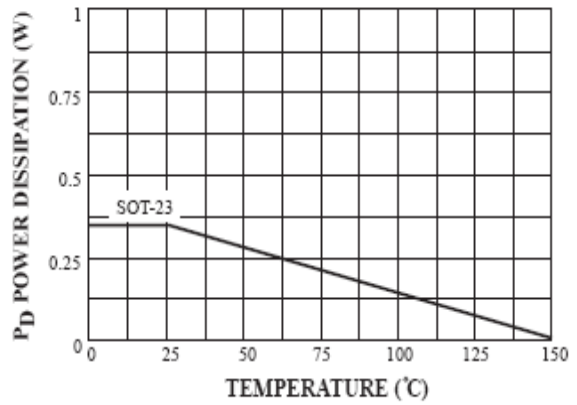
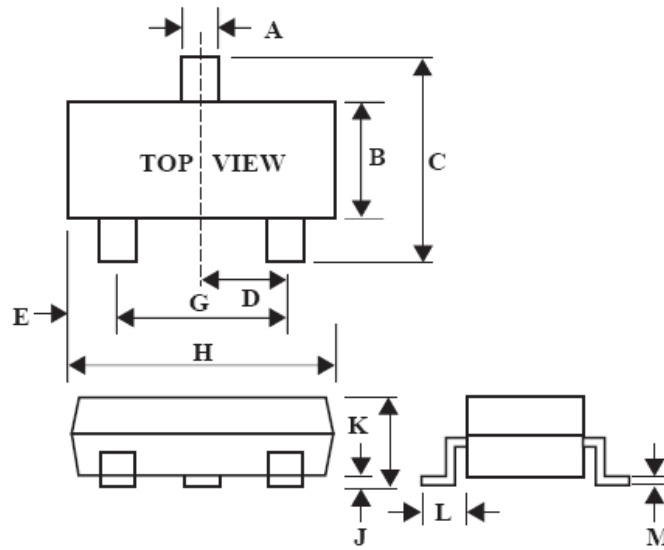

FIG.10 Power Dissipation vs Ambient Temperature

Package Dimension

SOT-23



Dimensions				
Symbol	Millimeters		Inches	
	Min	Max	Min	Max
A	0.35	0.51	0.014	0.020
B	1.19	1.40	0.047	0.055
C	2.10	3.00	0.083	0.118
D	0.85	1.05	0.033	0.041
E	0.46	1.00	0.018	0.039
G	1.70	2.10	0.067	0.083
H	2.70	3.10	0.106	0.122
J	0.01	0.13	0.000	0.005
K	0.89	1.10	0.035	0.043
L	0.30	0.61	0.011	0.024
M	0.076	0.25	0.002	0.010

NOTICE

Information furnished is believed to be accurate and reliable. However Globaltech Semiconductor assumes no responsibility for the consequences of use of such information nor for any infringement of patents or other rights of third parties, which may result from its use. No license is granted by implication or otherwise under any patent or patent rights of Globaltech Semiconductor. Specifications mentioned in this publication are subject to change without notice. This publication supersedes and replaces all information without express written approval of Globaltech Semiconductor.

CONTACT US

GS Headquarter	
	4F.,No.43-1,Lane11,Sec.6,Minquan E.Rd NeiHu District Taipei City 114, Taiwan (R.O.C)
	886-2-2657-9980
	886-2-2657-3630
	sales_twn@gs-power.com

Wu-Xi Branch	
	No.21 Changjiang Rd., WND, Wuxi, Jiangsu, China (INFO. & TECH. Science Park Building A 210 Room)
	86-510-85217051
	86-510-85211238
	sales_cn@gs-power.com

RD Division	
	824 Bolton Drive Milpitas. CA. 95035
	1-408-457-0587