

GSM5004S

40V N-Channel Enhancement Mode MOSFET

Product Description

GSM5004S, N-Channel enhancement mode MOSFET, uses Advanced Trench Technology to provide excellent $R_{DS(ON)}$, low gate charge.

These devices are particularly suited for low voltage power management, and low in-line power loss are needed in commercial industrial surface mount applications.

Features

- 40V/20A, $R_{DS(ON)} = 5.5m\Omega @ V_{GS} = 10V$
- 40V/15A, $R_{DS(ON)} = 6.5m\Omega @ V_{GS} = 4.5V$
- Super high density cell design for extremely low $R_{DS(ON)}$
- TO-252-2L package design

Applications

- Backlight Inverter for LCD Display
- DC/DC Converters

Packages & Pin Assignments

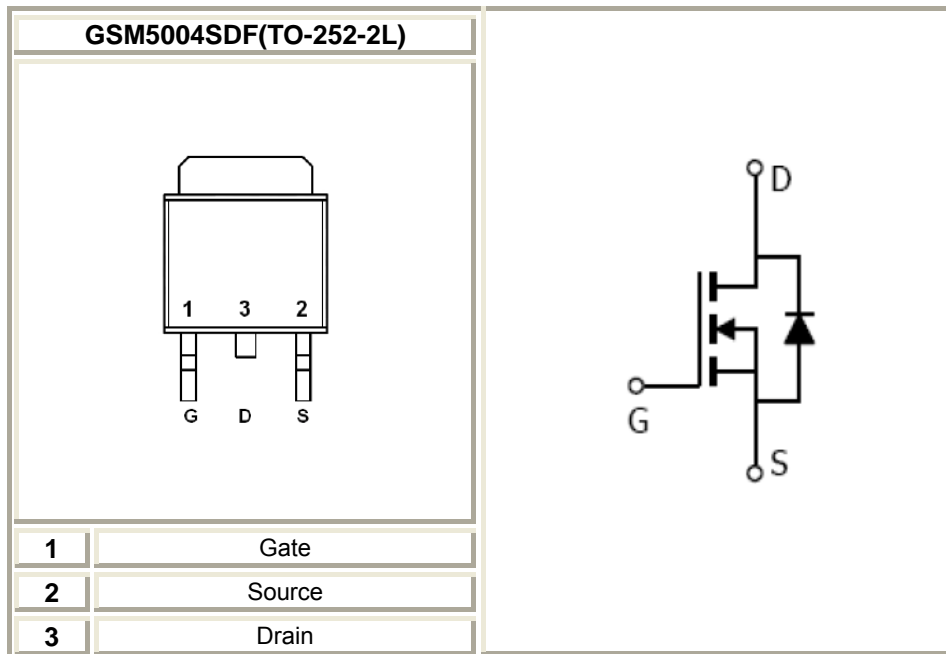

Ordering Information

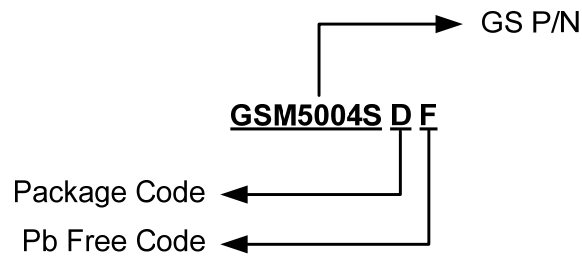

Part Number	Package	Quantity Reel
GSM5004SDF	TO-252-2L	2500 PCS

Marking Information

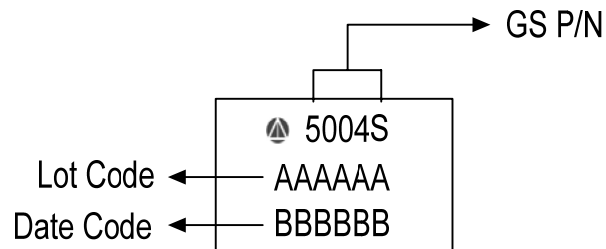

Absolute Maximum Ratings

($T_A=25^\circ\text{C}$ unless otherwise noted)

Symbol	Parameter	Typical	Unit	
V_{DSS}	Drain-Source Voltage	40	V	
V_{GSS}	Gate –Source Voltage	± 20	V	
I_D	Continuous Drain Current($T_J=150^\circ\text{C}$)	$T_A=25^\circ\text{C}$	15	A
		$T_A=70^\circ\text{C}$	12	
I_{DM}	Pulsed Drain Current	40	A	
I_S	Continuous Source Current(Diode Conduction)	2.6	A	
I_{AS}	Single Pulse Avalanche Current	L=0.1mH	25	A
E_{AS}	Avalanche Energy		35	mJ
P_D	Power Dissipation	$T_A=25^\circ\text{C}$	40	W
		$T_A=70^\circ\text{C}$	15	
T_J	Operating Junction Temperature	150	$^\circ\text{C}$	
T_{STG}	Storage Temperature Range	-55/150	$^\circ\text{C}$	
$R_{\theta JA}$	Thermal Resistance-Junction to Ambient	62.5	$^\circ\text{C}/\text{W}$	

Electrical Characteristics

(T_A=25°C unless otherwise noted)

Symbol	Parameter	Conditions	Min.	Typ	Max.	Unit
Static						
V _{(BR)DSS}	Drain-Source Breakdown Voltage	V _{GS} =0V, I _D =250μA	40			V
V _{GS(th)}	Gate Threshold Voltage	V _{DS} =V _{GS} , I _D =250μA	1.0		2.0	
I _{GSS}	Gate Leakage Current	V _{DS} =0V, V _{GS} =±20V			±100	nA
I _{DSS}	Zero Gate Voltage Drain Current	V _{DS} =32V, V _{GS} =0V			1	μA
		V _{DS} =32V, V _{GS} =0V, T _J =85°C			10	
I _{D(on)}	On-State Drain Current	V _{DS} ≥5V, V _{GS} =10V	50			A
R _{DS(on)}	Drain-Source On-Resistance	V _{GS} =10V, I _D =20A		3.5	5.5	mΩ
		V _{GS} =4.5V, I _D =15A		4.5	6.5	
g _{FS}	Forward Transconductance	V _{DS} =15V, I _D =15A		75		S
V _{SD}	Diode Forward Voltage	I _S =10A, V _{GS} =0V		0.85	1.3	V
Dynamic						
C _{iss}	Input Capacitance	V _{DS} =20V, V _{GS} =0V, f=1MHz		2500		pF
C _{oss}	Output Capacitance			280		
C _{rss}	Reverse Transfer Capacitance			120		
Q _g	Total Gate Charge	V _{DS} =20V, V _{GS} =4.5V, I _D =20A		18	30	nC
Q _{gs}	Gate-Source Charge			7		
Q _{gd}	Gate-Drain Charge			5		
t _{d(on)}	Turn-On Time	V _{DD} =20V, R _L =1Ω, I _D =20A V _{GEN} =10V, R _G =1Ω		10	20	ns
T _r				6	15	
t _{d(off)}	Turn-Off Time			40	65	
T _f				6	15	

Typical Performance Characteristics

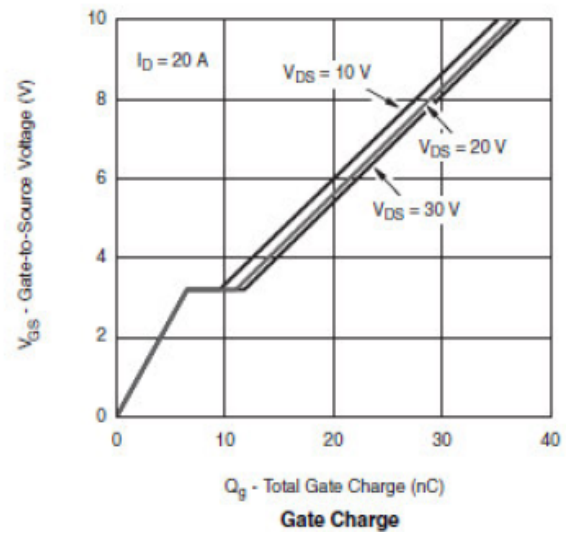
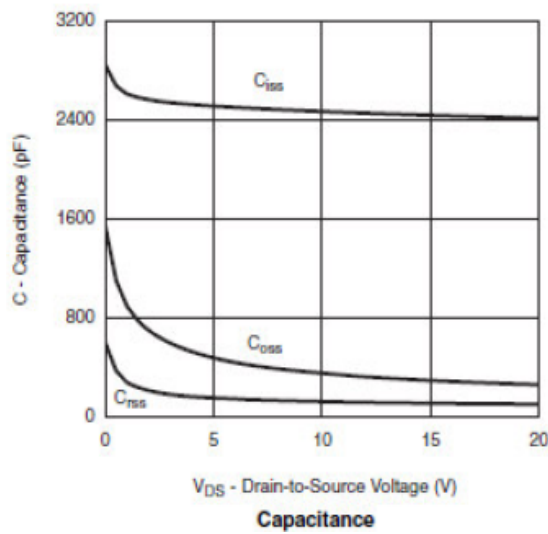
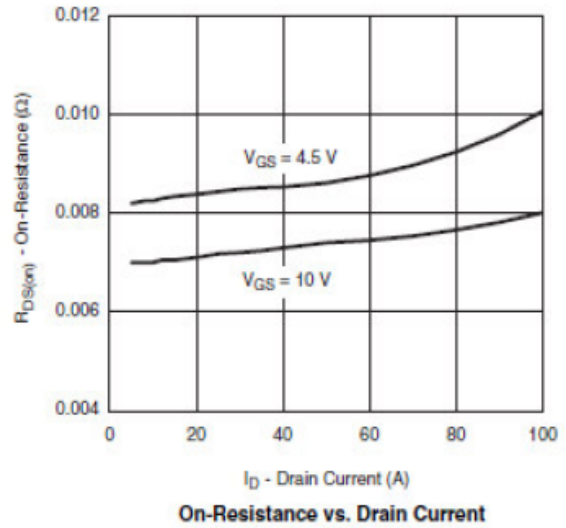
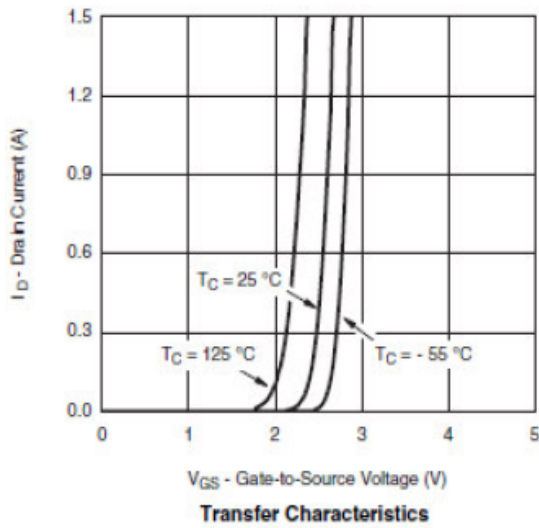
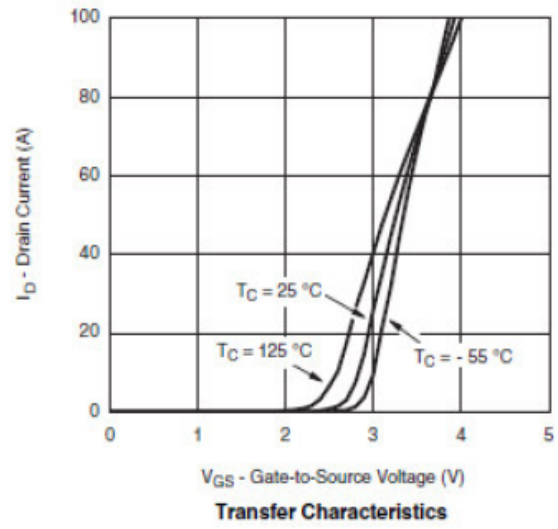
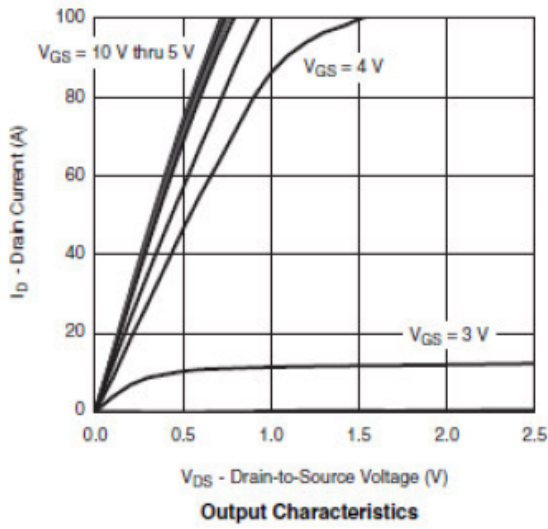

Typical Performance Characteristics (continue)

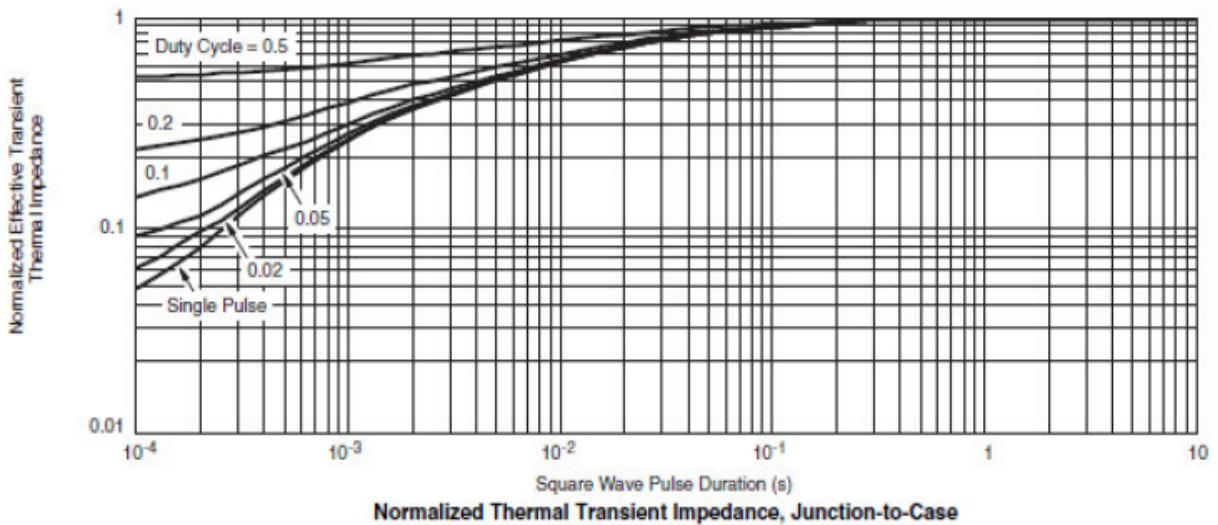
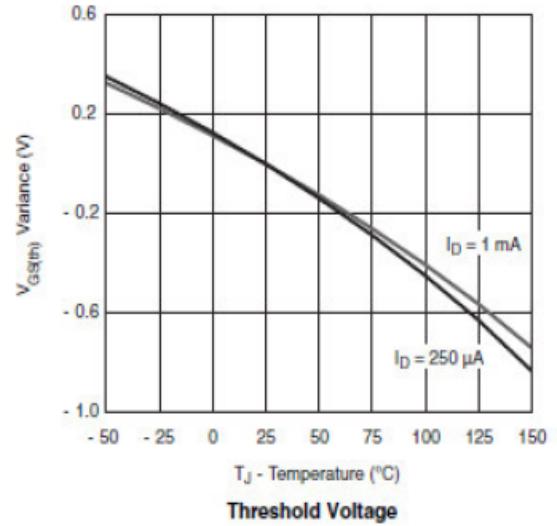
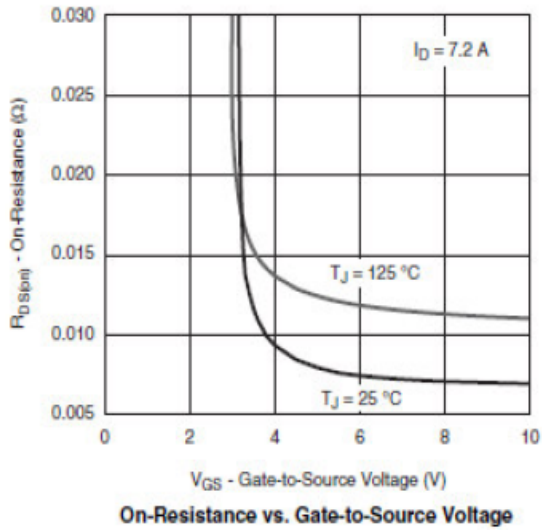
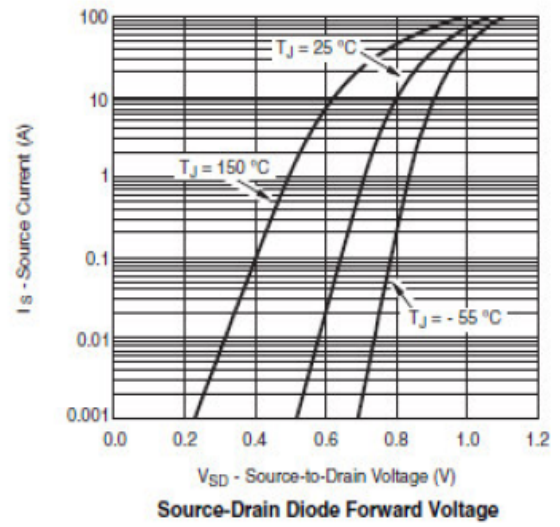
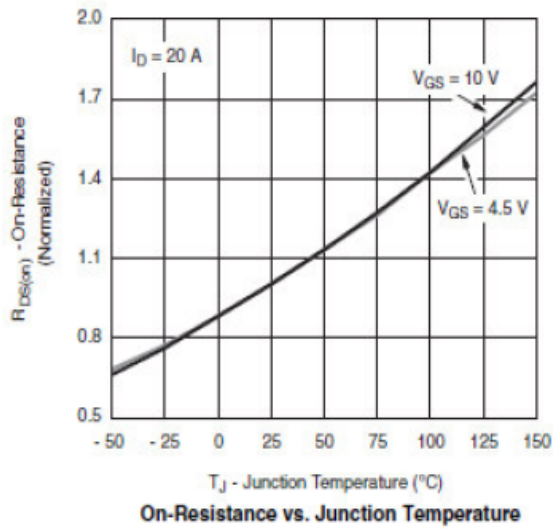

Typical Characteristics

Gate Charge Test Circuit & Waveform

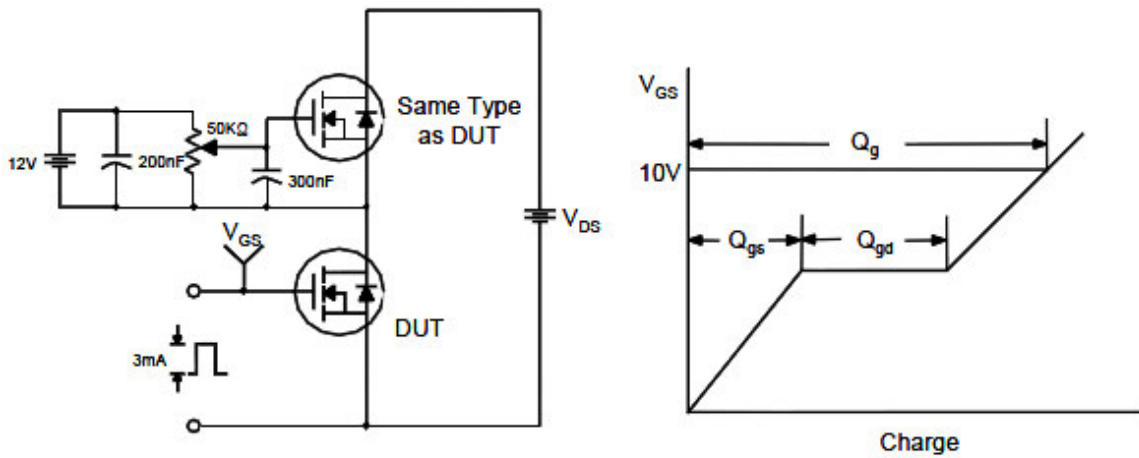

Resistive Switching Test Circuit & Waveforms

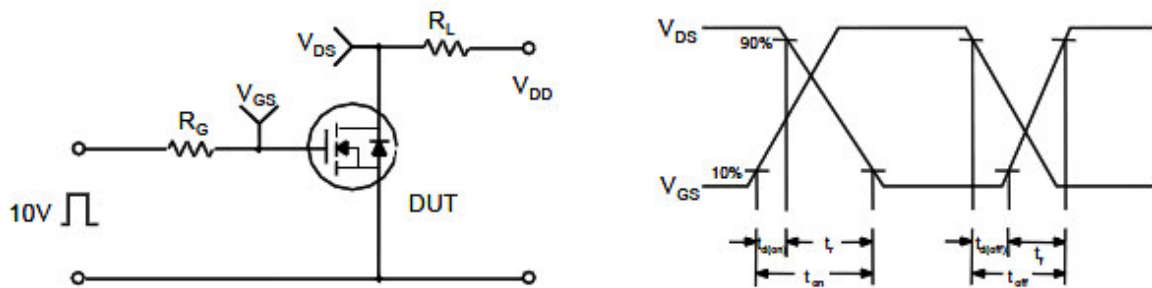

Unclamped Inductive Switching Test Circuit & Waveforms

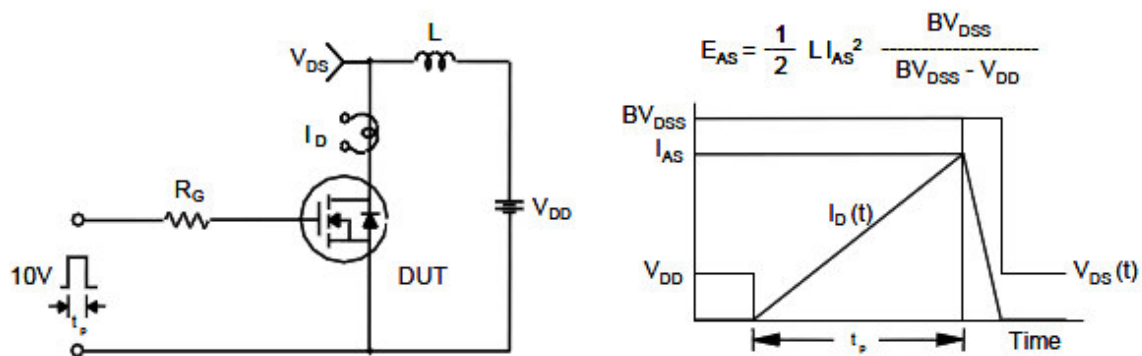

Package Dimension

TO-252-2L PLASTIC PACKAGE

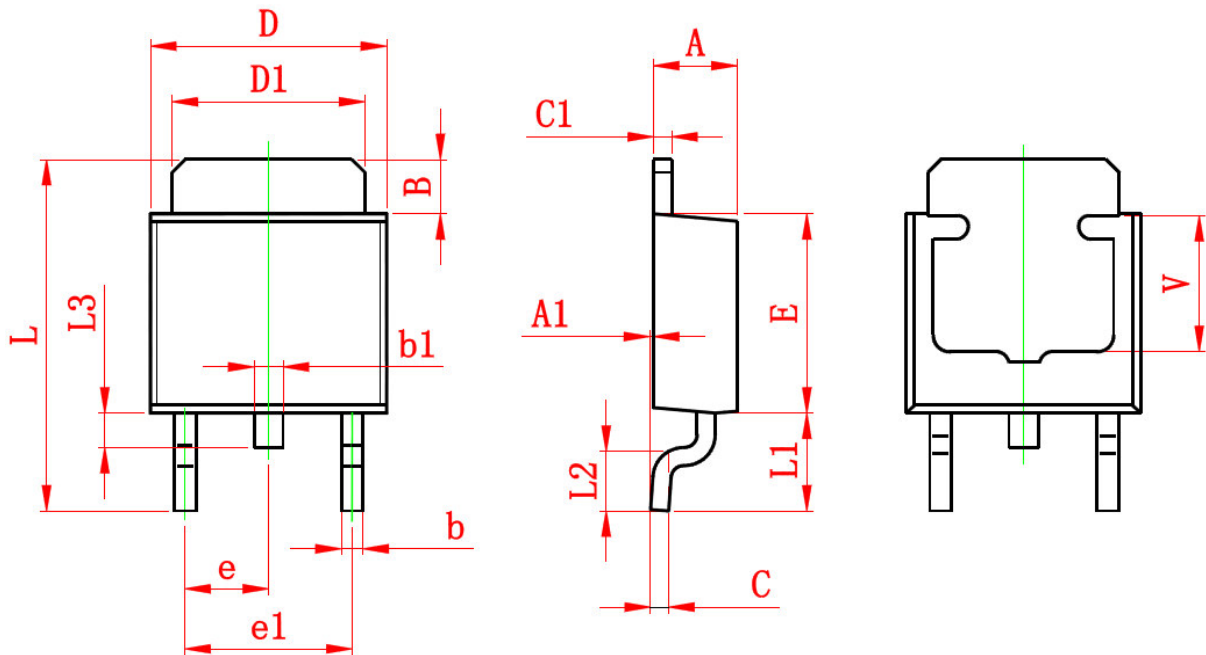





Dimensions





SYMBOL	Millimeters		Inches	
	MIN	MAX	MIN	MAX
A	2.200	2.400	0.087	0.094
A1	0.000	0.127	0.000	0.005
B	1.350	1.650	0.053	0.065
b	0.500	0.700	0.020	0.028
b1	0.700	0.900	0.028	0.035
c	0.430	0.580	0.017	0.023
c1	0.430	0.580	0.017	0.023
D	6.350	6.650	0.250	0.262
D1	5.200	5.400	0.205	0.213
E	5.400	5.700	0.213	0.224
e	2.300 TYP.		0.091 TYP.	
e1	4.500	4.700	0.177	0.185
L	9.500	9.900	0.374	0.390
L1	2.550	2.900	0.100	0.114
L2	1.400	1.780	0.055	0.070
L3	0.600	0.900	0.024	0.035
V	3.800 REF.		0.150 REF.	



NOTICE

Information furnished is believed to be accurate and reliable. However Globaltech Semiconductor assumes no responsibility for the consequences of use of such information nor for any infringement of patents or other rights of third parties, which may result from its use. No license is granted by implication or otherwise under any patent or patent rights of Globaltech Semiconductor. Specifications mentioned in this publication are subject to change without notice. This publication supersedes and replaces all information without express written approval of Globaltech Semiconductor.

CONTACT US

GS Headquarter	
	4F.,No.43-1,Lane11,Sec.6,Minquan E.Rd Neihu District Taipei City 114, Taiwan (R.O.C)
	886-2-2657-9980
	886-2-2657-3630
	sales_twn@gs-power.com

Wu-Xi Branch	
	No.21 Changjiang Rd., WND, Wuxi, Jiangsu, China (INFO. &. TECH. Science Park Building A 210 Room)
	86-510-85217051
	86-510-85211238
	sales_cn@gs-power.com

RD Division	
	824 Bolton Drive Milpitas. CA. 95035
	1-408-457-0587