

# GSM2014

## 20V N-Channel Enhancement Mode MOSFET

### Product Description

GSM2014, N-Channel enhancement mode MOSFET, uses Advanced Trench Technology to provide excellent  $R_{DS(ON)}$ , low gate charge.

These devices are particularly suited for low voltage power management, and low in-line power loss are needed in commercial industrial surface mount applications.

### Features

- 20V/10A,  $R_{DS(ON)}=14m\Omega@V_{GS}=4.5V$
- 20V/8A,  $R_{DS(ON)}=17m\Omega@V_{GS}=2.5V$
- 20V/5A,  $R_{DS(ON)}=21m\Omega@V_{GS}=1.8V$
- Super high density cell design for extremely low  $R_{DS(ON)}$
- TO-252-2L package design

### Applications

- Power Management in Desktop Computer
- DC/DC Converter
- LCD Display inverter

### Packages & Pin Assignments

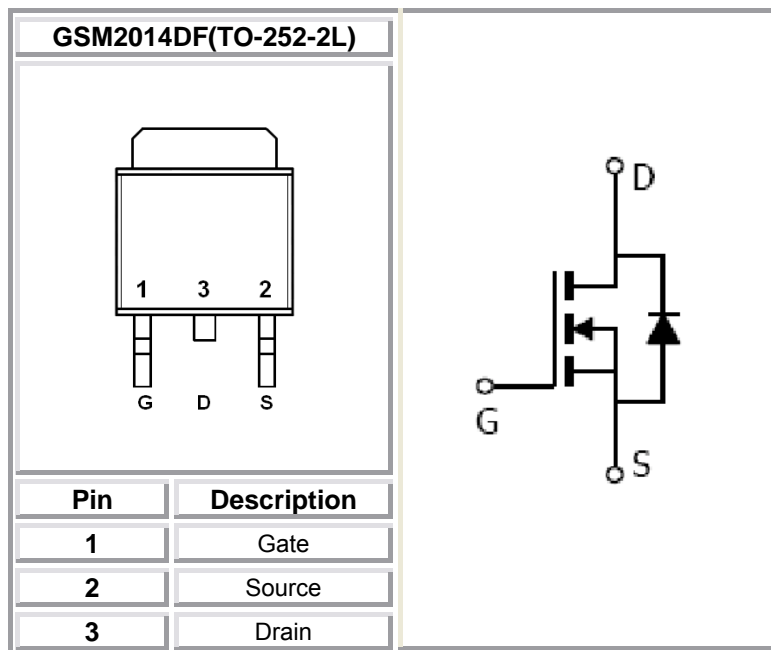

## Ordering Information

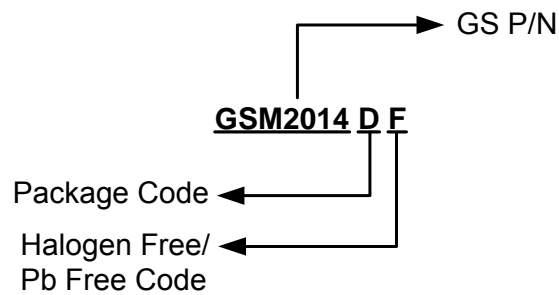

Part Number	Package	Quantity Reel
GSM2014DF	TO-252-2L	2500 PCS

## Marking Information

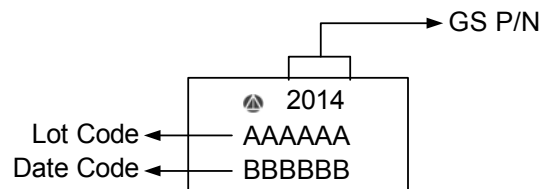

## Absolute Maximum Ratings

T<sub>A</sub>=25°C unless otherwise noted

Symbol	Parameter	Typical	Unit
V <sub>DSS</sub>	Drain-Source Voltage	20	V
V <sub>GSS</sub>	Gate –Source Voltage	±12	V
I <sub>D</sub>	Continuous Drain Current(T <sub>J</sub> =150°C)	T <sub>A</sub> =25°C	A
		T <sub>A</sub> =70°C	
I <sub>DM</sub>	Pulsed Drain Current	50	
I <sub>S</sub>	Continuous Source Current(Diode Conduction)	9.0	
P <sub>D</sub>	Power Dissipation	T <sub>A</sub> =25°C	W
		T <sub>A</sub> =70°C	
T <sub>J</sub>	Operating Junction Temperature	150	°C
T <sub>STG</sub>	Storage Temperature Range	-55/150	°C
R <sub>θJA</sub>	Thermal Resistance-Junction to Ambient	62.5	°C/ W

## Electrical Characteristics

T<sub>A</sub>=25°C unless otherwise noted

Symbol	Parameter	Conditions	Min	Typ	Max	Unit
<b>Static</b>						
V <sub>(BR)DSS</sub>	Drain-Source Breakdown Voltage	V <sub>GS</sub> =0V, I <sub>D</sub> =250μA	20			V
V <sub>GS(th)</sub>	Gate Threshold Voltage	V <sub>DS</sub> =V <sub>GS</sub> , I <sub>D</sub> =250μA	0.4		1.0	V
I <sub>GSS</sub>	Gate Leakage Current	V <sub>DS</sub> =0V, V <sub>GS</sub> =±12V			±100	nA
I <sub>DSS</sub>	Zero Gate Voltage Drain Current	V <sub>DS</sub> =20V, V <sub>GS</sub> =0V			1	μA
		V <sub>DS</sub> =20V, V <sub>GS</sub> =0V, T <sub>J</sub> =85°C			10	
I <sub>D(on)</sub>	On-State Drain Current	V <sub>DS</sub> ≥5V, V <sub>GS</sub> =4.5V	30			A
R <sub>DS(on)</sub>	Drain-Source On-Resistance	V <sub>GS</sub> =4.5V, I <sub>D</sub> =10A		11	14	mΩ
		V <sub>GS</sub> =2.5V, I <sub>D</sub> =8A		14	17	
		V <sub>GS</sub> =1.8V, I <sub>D</sub> =5A		17	21	
g <sub>FS</sub>	Forward Transconductance	V <sub>DS</sub> =10V, I <sub>D</sub> =7.0A		40		S
V <sub>SD</sub>	Diode Forward Voltage	I <sub>S</sub> =5.0A, V <sub>GS</sub> =0V		0.8	1.3	V
<b>Dynamic</b>						
C <sub>iss</sub>	Input Capacitance	V <sub>DS</sub> =10V, V <sub>GS</sub> =0V, f=1MHz		1450		pF
C <sub>oss</sub>	Output Capacitance			285		
C <sub>rss</sub>	Reverse Transfer Capacitance			145		
Q <sub>g</sub>	Total Gate Charge	V <sub>DS</sub> =10V, V <sub>GS</sub> =4.5V, I <sub>D</sub> =9.0A		13	19	nC
Q <sub>gs</sub>	Gate-Source Charge			2.8		
Q <sub>gd</sub>	Gate-Drain Charge			2.0		
t <sub>d(on)</sub>	Turn-On Time	V <sub>DD</sub> =10V, R <sub>L</sub> =1.3Ω, I <sub>D</sub> =8.0A, V <sub>GEN</sub> =10V, R <sub>G</sub> =1Ω		10	20	ns
t <sub>r</sub>				10	20	
t <sub>d(off)</sub>	Turn-Off Time			25	40	
t <sub>f</sub>				10	20	

## Typical Performance Characteristics

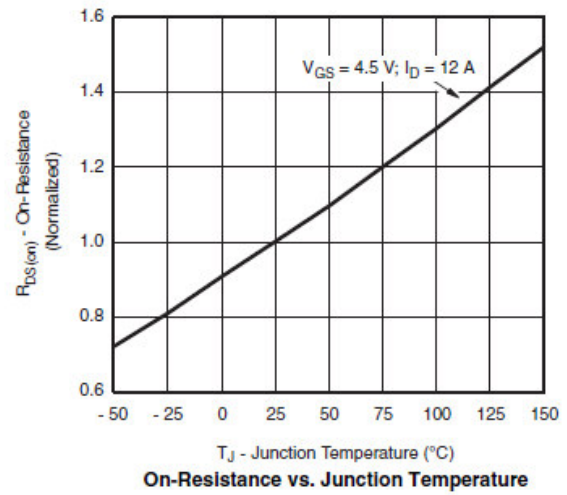
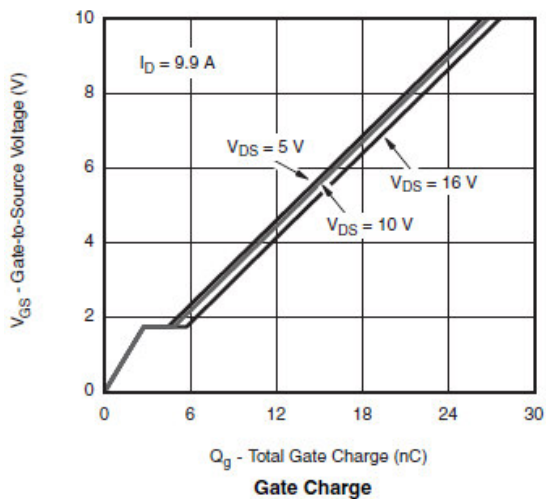
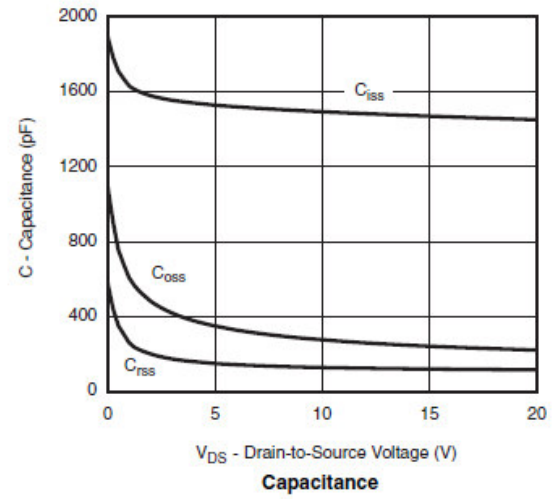
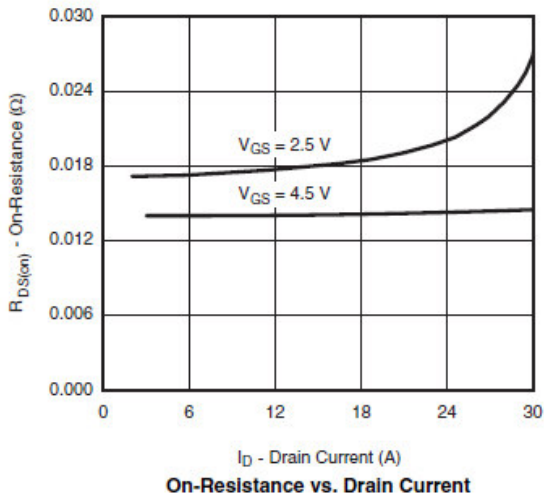
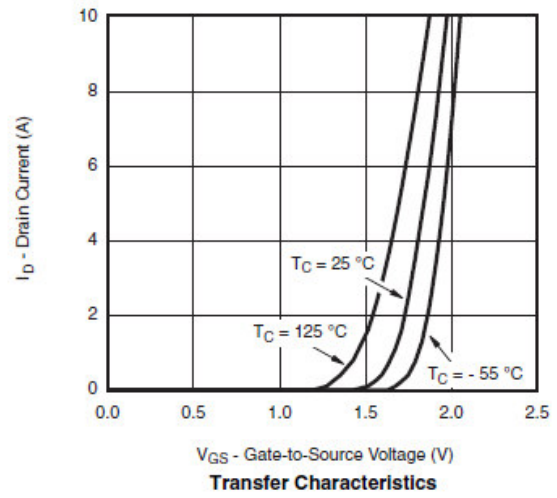
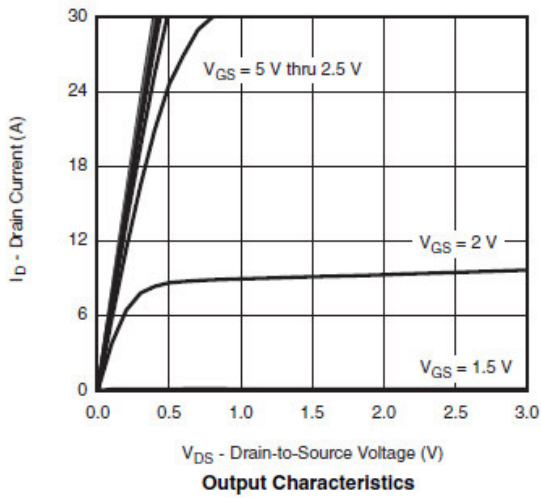

## Typical Performance Characteristics (continue)

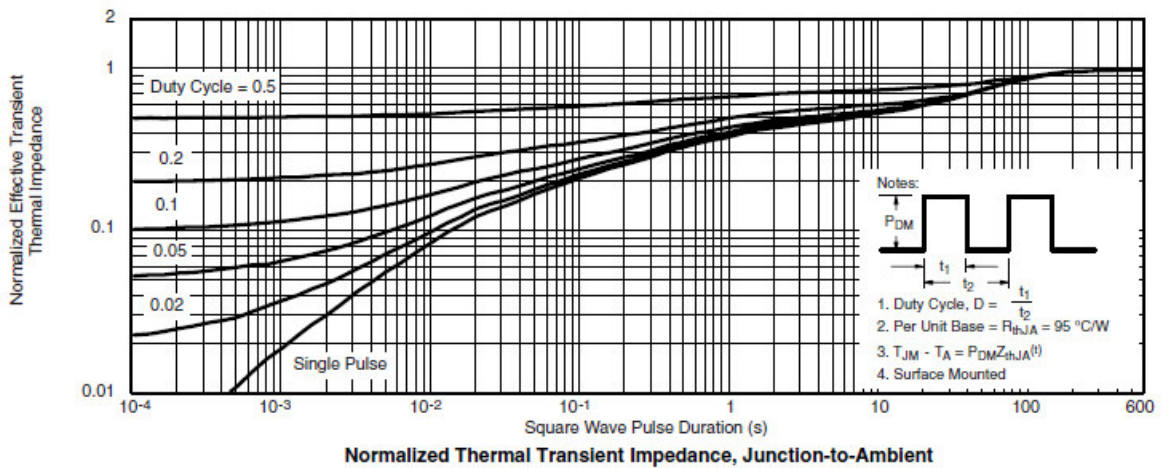
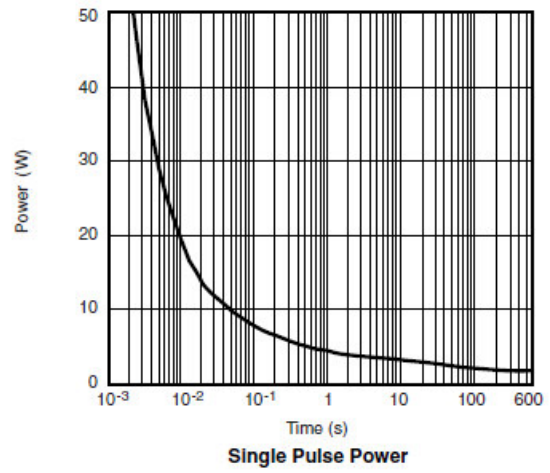
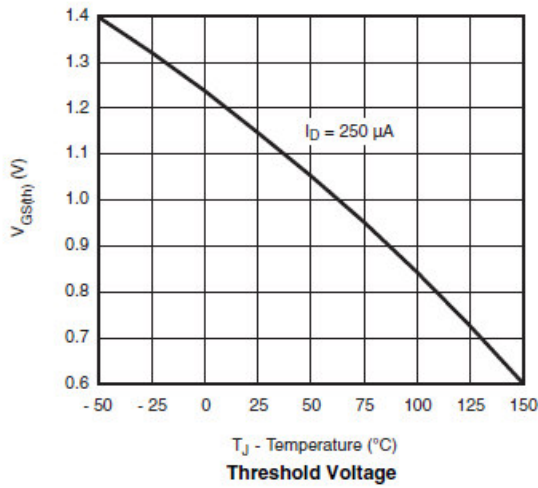
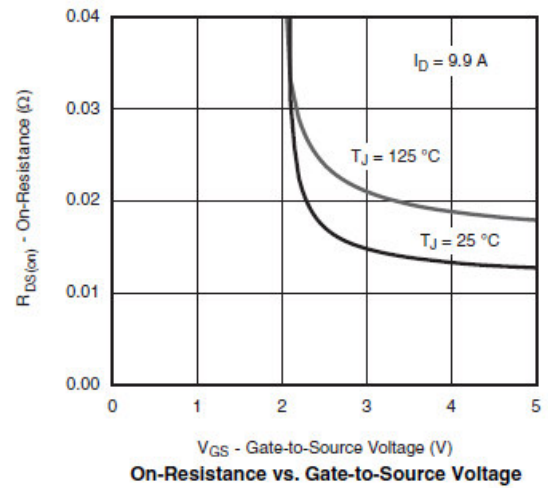
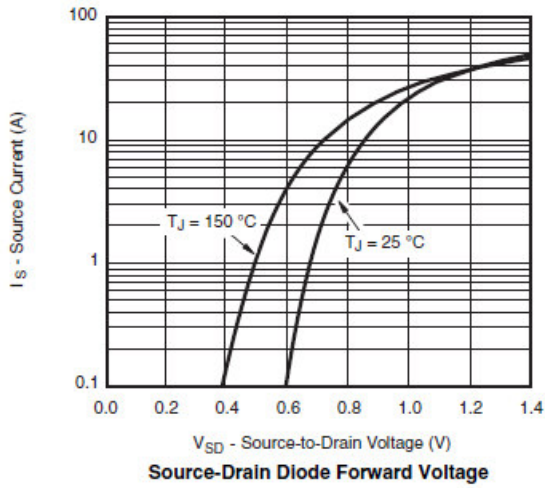

## Typical Performance Characteristics (continue)

### Gate Charge Test Circuit & Waveform

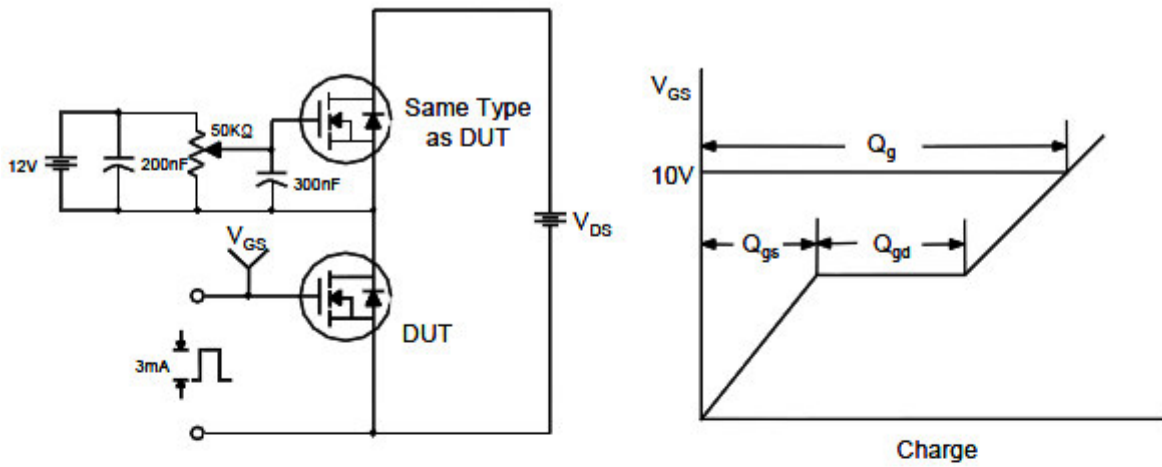

### Resistive Switching Test Circuit & Waveforms

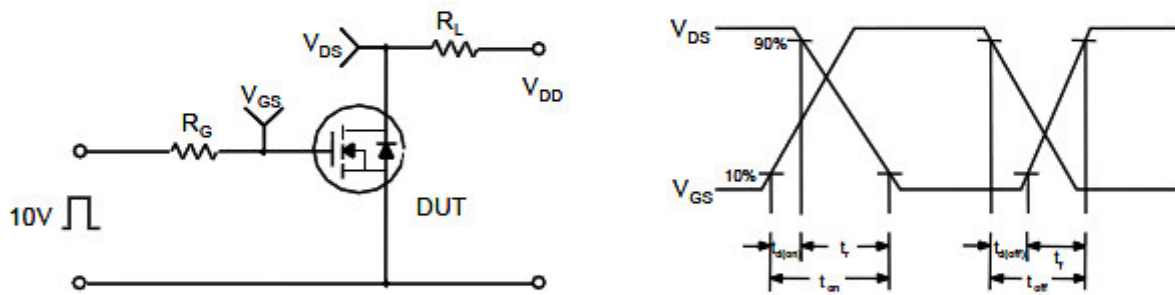

### Unclamped Inductive Switching Test Circuit & Waveforms

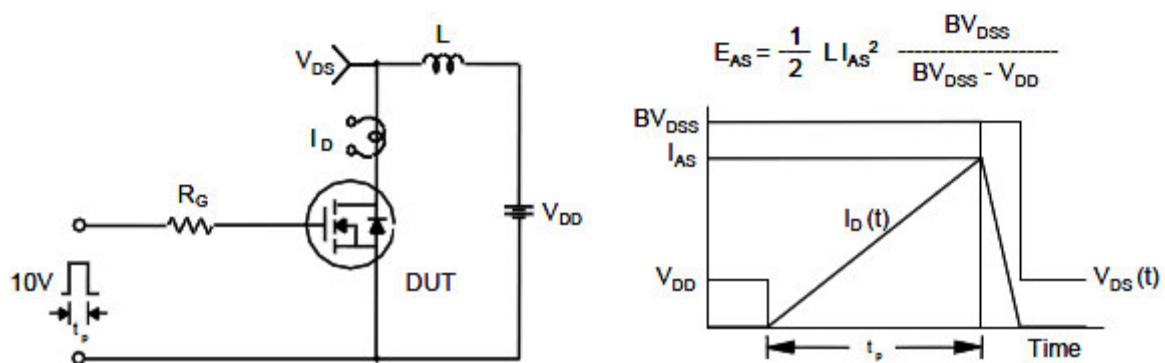

Package Dimension

## TO-252-2L PLASTIC PACKAGE

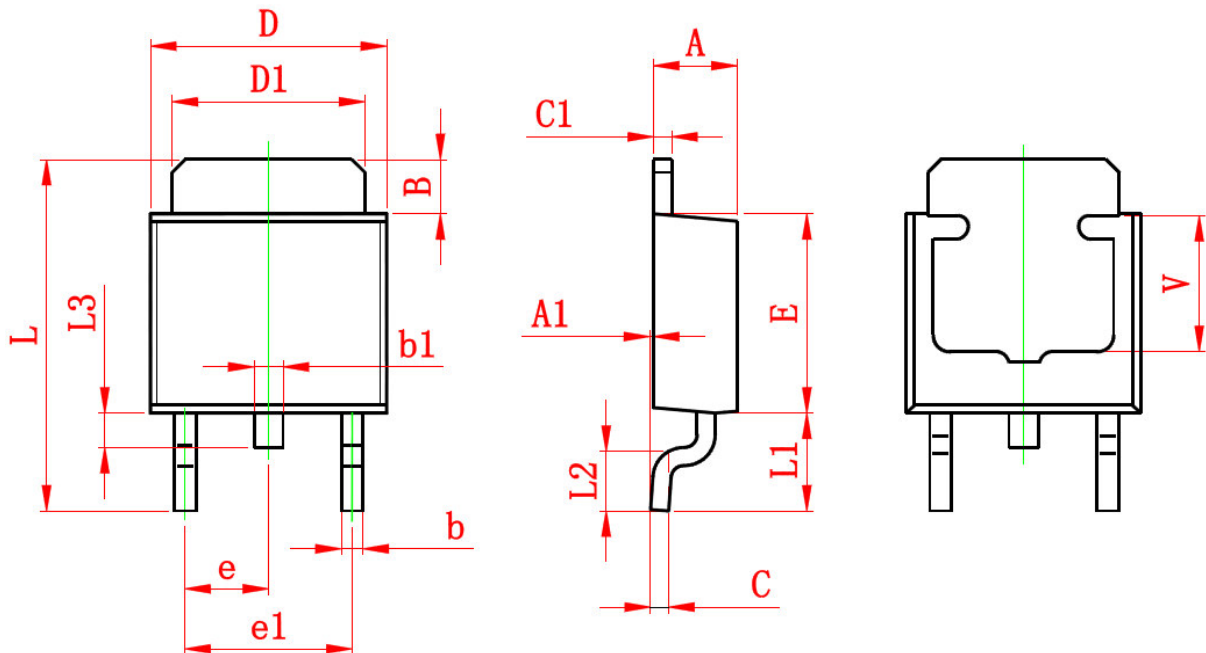





### Dimensions

SYMBOL	Millimeters		Inches	
	MIN	MAX	MIN	MAX
A	2.200	2.400	0.087	0.094
A1	0.000	0.127	0.000	0.005
B	1.350	1.650	0.053	0.065
b	0.500	0.700	0.020	0.028
b1	0.700	0.900	0.028	0.035
c	0.430	0.580	0.017	0.023
c1	0.430	0.580	0.017	0.023
D	6.350	6.650	0.250	0.262
D1	5.200	5.400	0.205	0.213
E	5.400	5.700	0.213	0.224
e	2.300 TYP		0.091 TYP	
e1	4.500	4.700	0.177	0.185
L	9.500	9.900	0.374	0.390
L1	2.550	2.900	0.100	0.114
L2	1.400	1.780	0.055	0.070
L3	0.600	0.900	0.024	0.035
V	3.800 REF		0.150 REF	



## NOTICE

Information furnished is believed to be accurate and reliable. However Globaltech Semiconductor assumes no responsibility for the consequences of use of such information nor for any infringement of patents or other rights of third parties, which may result from its use. No license is granted by implication or otherwise under any patent or patent rights of Globaltech Semiconductor. Specifications mentioned in this publication are subject to change without notice. This publication supersedes and replaces all information without express written approval of Globaltech Semiconductor.

## CONTACT US

GS Headquarter	
	4F.,No.43-1,Lane11,Sec.6,Minquan E.Rd Neihu District Taipei City 114, Taiwan (R.O.C)
	886-2-2657-9980
	886-2-2657-3630
	sales_twn@gs-power.com

Wu-Xi Branch	
	No.21 Changjiang Rd., WND, Wuxi, Jiangsu, China (INFO. &. TECH. Science Park Building A 210 Room)
	86-510-85217051
	86-510-85211238
	sales_cn@gs-power.com

RD Division	
	824 Bolton Drive Milpitas. CA. 95035
	1-408-457-0587