

GSM7424S

30V N-Channel Enhancement Mode MOSFET

Product Description

GSM7424S, N-Channel enhancement mode MOSFET, uses Advanced Trench Technology to provide excellent $R_{DS(ON)}$, low gate charge.

These devices are particularly suited for low voltage power management, such as smart phone and notebook computer and other battery powered circuits, and low in-line power loss are needed in commercial industrial surface mount applications.

Features

- 30V/20A, $R_{DS(ON)}=5m\Omega@V_{GS}=10V$
- 30V/15A, $R_{DS(ON)}=7m\Omega@V_{GS}=4.5V$
- Super high density cell design for extremely low $R_{DS(ON)}$
- Exceptional on-resistance and maximum DC current capability
- DFN3.3X3.3-8L package design

Applications

- DC-DC Converter
- POL

Packages & Pin Assignments

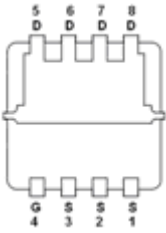
GSM7424SFF (DFN3.3X3.3-8L)	
 <p>Bottom View</p>	
Pin	Description
1	Source
2	Source
3	Source
4	Gate
5	Drain
6	Drain
7	Drain
8	Drain

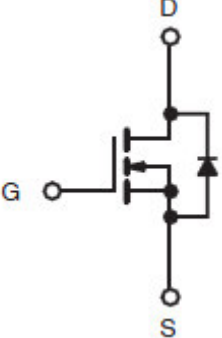

Ordering Information

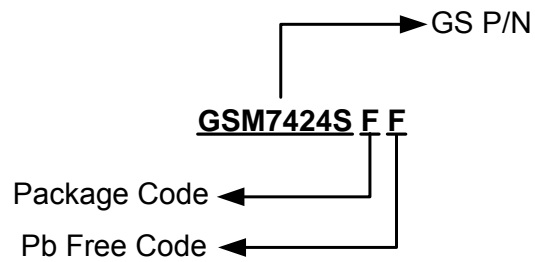

Part Number	Package	Quantity Reel
GSM7424SFF	DFN3.3X3.3-8L	5000 PCS

Marking Information

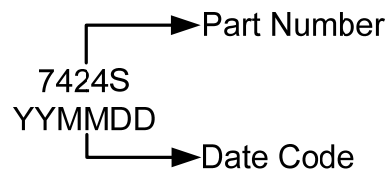

Absolute Maximum Ratings

T_A=25°C Unless otherwise noted

Symbol	Parameter	Typical	Unit
V _{DSS}	Drain-Source Voltage	30	V
V _{GSS}	Gate –Source Voltage	±20	V
I _D	Continuous Drain Current (T _J =150°C)	T _A =25°C	20
		T _A =70°C	15
I _{DM}	Pulsed Drain Current	70	A
I _S	Continuous Source Current (Diode Conduction)	40	A
P _D	Power Dissipation	T _A =25°C	3.8
		T _A =70°C	2
T _J	Operating Junction Temperature	150	°C
T _{STG}	Storage Temperature Range	-55/150	°C
R _{θJA}	Thermal Resistance-Junction to Ambient	120	°C/W

Electrical Characteristics

T_A=25°C Unless otherwise noted

Symbol	Parameter	Conditions	Min	Typ	Max	Unit
Static						
V _{(BR)DSS}	Drain-Source Breakdown Voltage	V _{GS} =0V, I _D =250μA	30			V
V _{GS(th)}	Gate Threshold Voltage	V _{DS} =V _{GS} , I _D =250μA	1.0		2.0	V
I _{GSS}	Gate Leakage Current	V _{DS} =0V, V _{GS} =±20V			±100	nA
I _{DSS}	Zero Gate Voltage Drain Current	V _{DS} =24V, V _{GS} =0V			1	μA
		V _{DS} =24V, V _{GS} =0V, T _J =85°C			10	
I _{D(ON)}	On-State Drain Current	V _{DS} ≥5V, V _{GS} =10V	50			A
R _{DS(on)}	Drain-Source On-Resistance	V _{GS} =10V, I _D =20A		3.6	5	mΩ
		V _{GS} =4.5V, I _D =15A		5.5	7	
g _{FS}	Forward Transconductance	V _{DS} =15V, I _D =20A		80		S
V _{SD}	Diode Forward Voltage	I _S =10A, V _{GS} =0V		0.8	1.3	V
Dynamic						
Q _g	Total Gate Charge	V _{DS} =15V, V _{GS} =4.5V, I _D =20A		15	25	nC
Q _{gs}	Gate-Source Charge			6		
Q _{gd}	Gate-Drain Charge			5		
C _{iss}	Input Capacitance	V _{DS} =15V, V _{GS} =0V, f=1MHz		1800		pF
C _{oss}	Output Capacitance			350		
C _{rss}	Reverse Transfer Capacitance			150		
t _{d(on)}	Turn-On Time	V _{DD} =15V, R _L =1.5Ω, I _D =10A, V _{GEN} =10V, R _G =1.0Ω		12	20	ns
t _r				10	20	
t _{d(off)}	Turn-Off Time			25	45	
t _f				10	20	

Typical Performance Characteristics

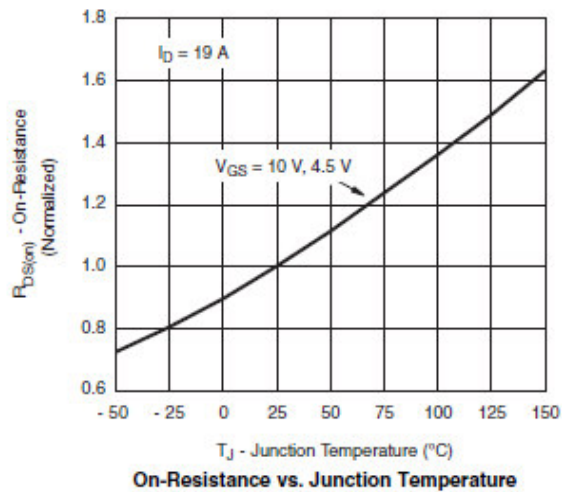
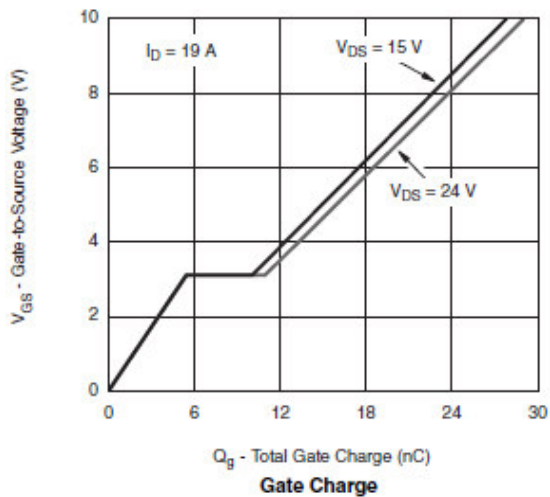
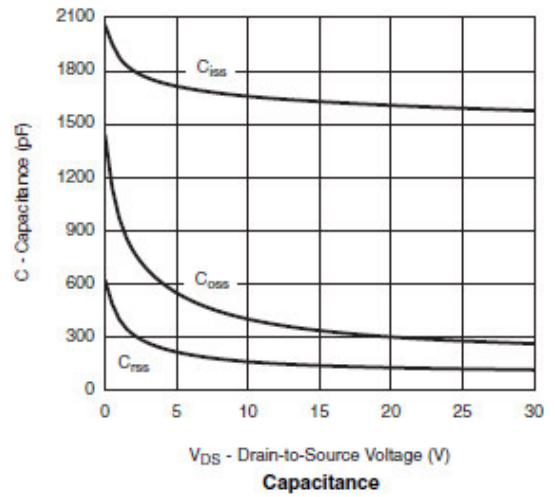
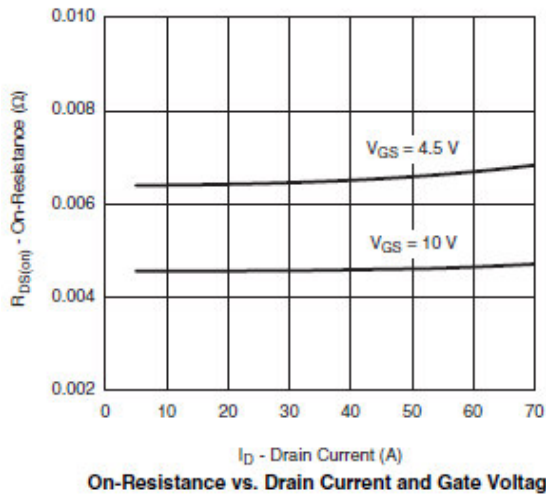
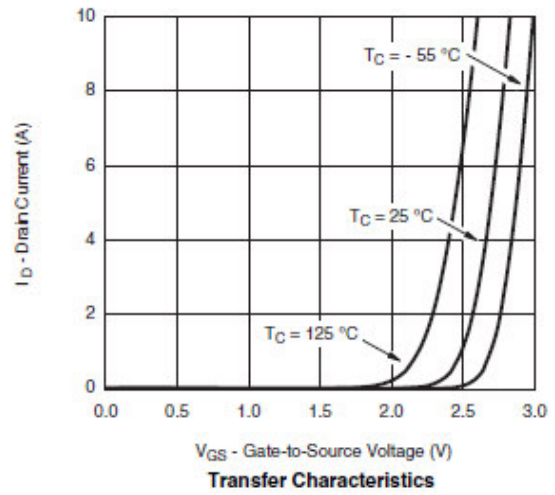
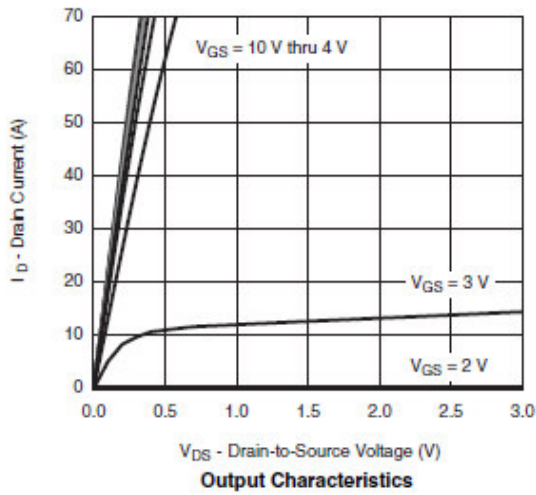

Typical Performance Characteristics (Continue)

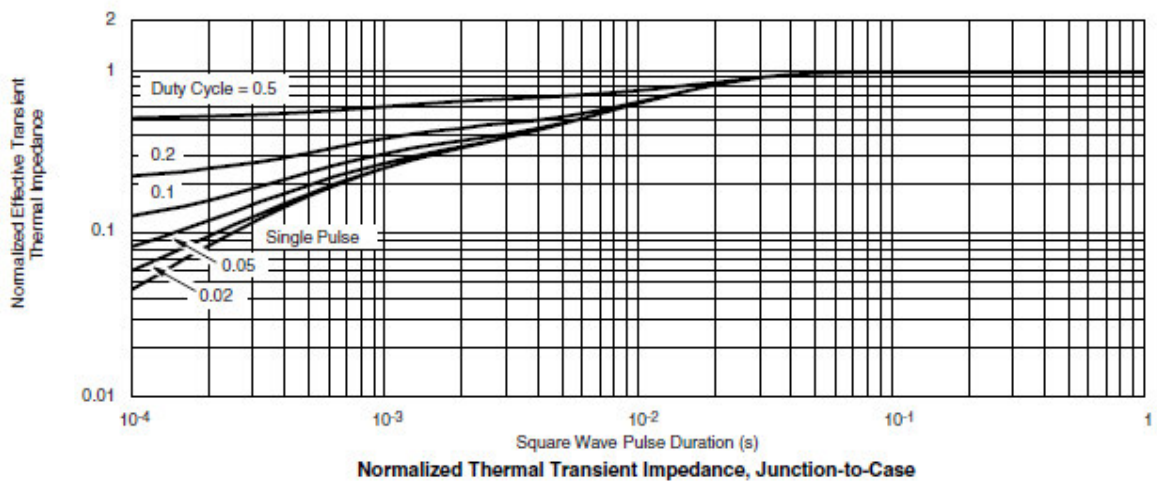
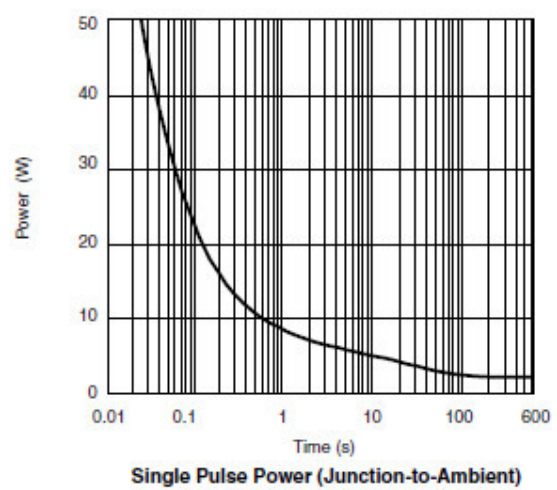
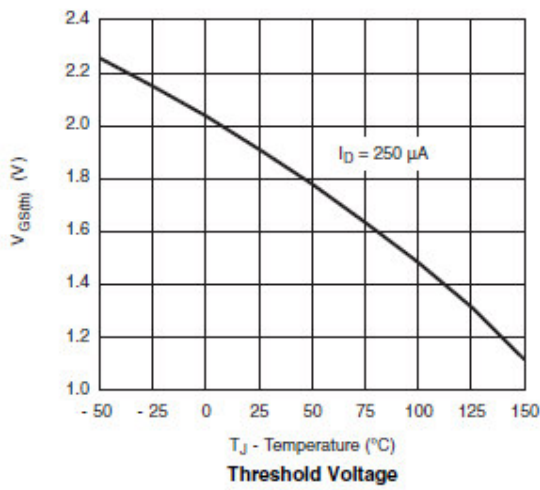
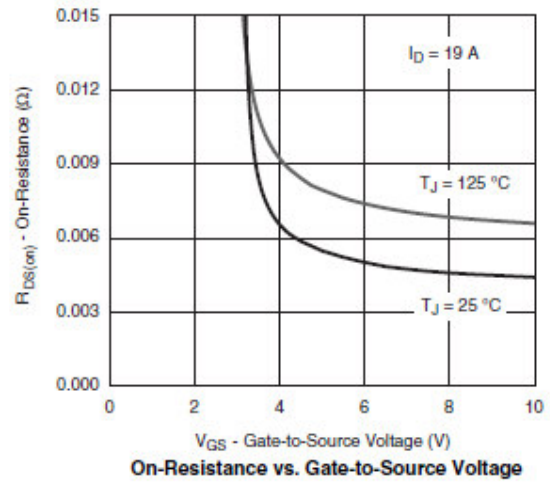
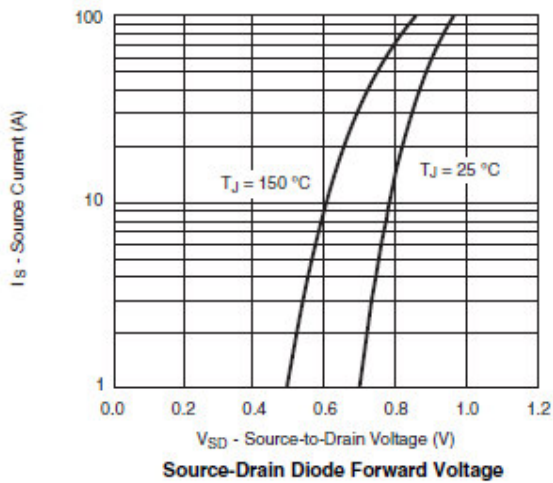

Typical Performance Characteristics (Continue)

Gate Charge Test Circuit & Waveform

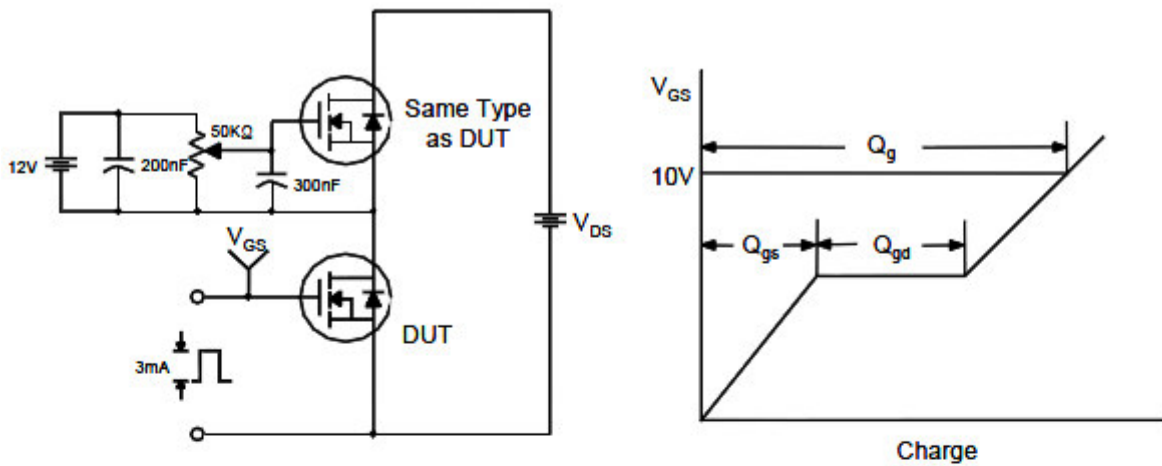

Resistive Switching Test Circuit & Waveforms

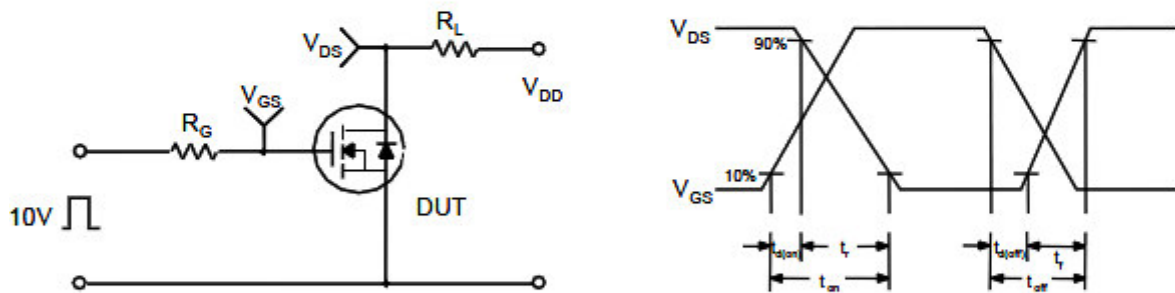

Unclamped Inductive Switching Test Circuit & Waveforms

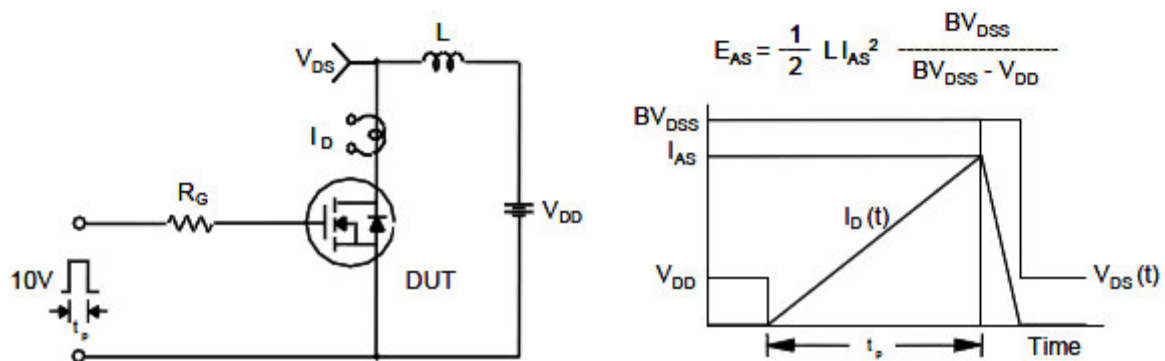

Package Dimension

DFN3.3X3.3-8L

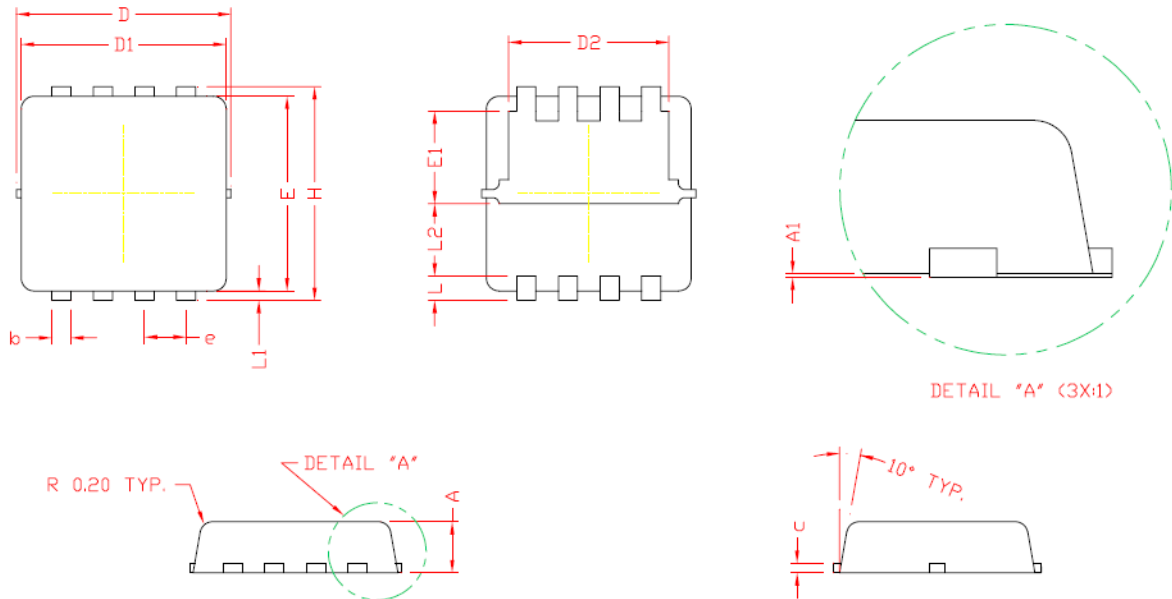





Dimensions				
SYMBOL	Millimeters		Inches	
	MIN	MAX	MIN	MAX
A	0.70	0.90	0.027	0.035
A1	0.00	0.05	0.000	0.019
b	0.24	0.35	0.009	0.013
c	0.10	0.20	0.003	0.007
D	3.25	3.40	0.127	0.133
D1	3.05	3.25	0.120	0.127
D2	2.40	2.60	0.09	0.102
E	3.00	3.20	0.118	0.125
E1	1.35	1.55	0.053	0.061
e	0.65 (BSC)		0.025 (BSC)	
H	3.20	3.40	0.125	0.133
L	0.30	0.50	0.011	0.019
L1	0.10	0.20	0.003	0.007
L2	1.13 (REF)		0.044 (REF)	



NOTICE

Information furnished is believed to be accurate and reliable. However Globaltech Semiconductor assumes no responsibility for the consequences of use of such information nor for any infringement of patents or other rights of third parties, which may result from its use. No license is granted by implication or otherwise under any patent or patent rights of Globaltech Semiconductor. Specifications mentioned in this publication are subject to change without notice. This publication supersedes and replaces all information without express written approval of Globaltech Semiconductor.

CONTACT US

GS Headquarter	
	4F.,No.43-1,Lane11,Sec.6,Minquan E.Rd NeiHu District Taipei City 114, Taiwan (R.O.C)
	886-2-2657-9980
	886-2-2657-3630
	sales_twn@gs-power.com

Wu-Xi Branch	
	No.21 Changjiang Rd., WND, Wuxi, Jiangsu, China (INFO. & TECH. Science Park Building A 210 Room)
	86-510-85217051
	86-510-85211238
	sales_cn@gs-power.com

RD Division	
	824 Bolton Drive Milpitas. CA. 95035
	1-408-457-0587