

GSM8988

100V N-Channel Enhancement Mode MOSFET

Product Description

GSM8988, N-Channel enhancement mode MOSFET, uses Advanced Trench Technology to provide excellent $R_{DS(ON)}$, low gate charge.

These devices are particularly suited for low voltage power management, and low in-line power loss are needed in commercial industrial surface mount applications.

Features

- 100V/4.6A, $R_{DS(ON)}=120m\Omega@V_{GS}=10V$
- 100V/3.6A, $R_{DS(ON)}=130m\Omega@V_{GS}=4.5V$
- Super high density cell design for extremely low $R_{DS(ON)}$
- SOT-89-3L package design

Applications

- Motor and Load Control
- Power Management in White LED System
- Push Pull Converter
- LCD TV Inverter & AD/DC Inverter Systems.

Packages & Pin Assignments

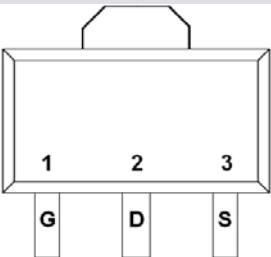
GSM8988YF(SOT-89-3L)	
	
Pin	Description
1	Gate
2	Drain
3	Source

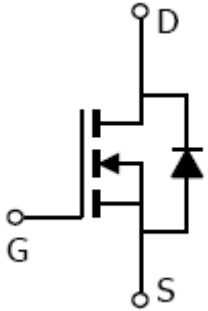

Ordering Information

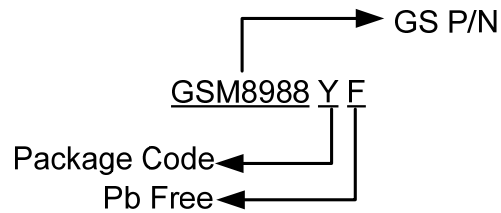

Part Number	Package	Quantity Reel
GSM8988YF	SOT-89-3L	1000 PCS

Marking Information

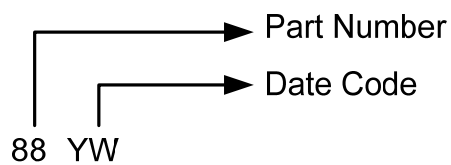

Absolute Maximum Ratings

$T_A=25^{\circ}\text{C}$ Unless otherwise noted

Symbol	Parameter	Typical	Unit	
V_{DSS}	Drain-Source Voltage	100	V	
V_{GSS}	Gate –Source Voltage	± 20	V	
I_D	Continuous Drain Current($T_J=150^{\circ}\text{C}$)	$T_A = 25^{\circ}\text{C}$	4.6	A
		$T_A = 70^{\circ}\text{C}$	3.6	
I_{DM}	Pulsed Drain Current	10	A	
I_S	Continuous Source Current(Diode Conduction)	1.6	A	
P_D	Power Dissipation	$T_A = 25^{\circ}\text{C}$	1.45	W
		$T_A = 70^{\circ}\text{C}$	0.6	
T_J	Operating Junction Temperature	150	$^{\circ}\text{C}$	
T_{STG}	Storage Temperature Range	-55 to 150	$^{\circ}\text{C}$	
$R_{\theta JA}$	Thermal Resistance-Junction to Ambient	120	$^{\circ}\text{C}/\text{W}$	

Electrical Characteristics

T_A=25°C Unless otherwise noted

Symbol	Parameter	Conditions	Min	Typ	Max	Unit
Static						
V _{(BR)DSS}	Drain-Source Breakdown Voltage	V _{GS} =0V, I _D = 250uA	100			V
V _{GS(th)}	Gate Threshold Voltage	V _{DS} =V _{GS} , I _D = 250uA	0.5		2.5	
I _{GSS}	Gate Leakage Current	V _{DS} =0V, V _{GS} = ±20V			±100	nA
I _{DSS}	Zero Gate Voltage Drain Current	V _{DS} = 80V, V _{GS} =0V			1	uA
		V _{DS} =80V, V _{GS} =0V, T _J =85°C			5	
I _{D(on)}	On-State Drain Current	V _{DS} ≥ 5V, V _{GS} = 4.5V	10			A
R _{DS(on)}	Drain-Source On-Resistance	V _{GS} = 10V, I _D = 4.8A		100	120	mΩ
		V _{GS} = 4.5V, I _D = 3.6A		110	130	
g _{FS}	Forward Transconductance	V _{DS} = 15V, I _D = 5.3A		24		S
V _{SD}	Diode Forward Voltage	I _S = 2.0A, V _{GS} =0V		0.8	1.2	V
Dynamic						
Q _g	Total Gate Charge	V _{DS} =50V, V _{GS} =5V, I _D =3A		12	18	nC
Q _{gs}	Gate-Source Charge			4.2		
Q _{gd}	Gate-Drain Charge			5.2		
C _{iss}	Input Capacitance	V _{DS} =50V, V _{GS} =0V, f=1MHz		600		pF
C _{oss}	Output Capacitance			90		
C _{rss}	Reverse Transfer Capacitance			60		
t _{d(on)}	Turn-On Time	V _{DD} =50V, R _L =12.5Ω, I _D =3.0A, V _{GEN} =10V, R _G =1Ω		15	25	ns
t _r				15	25	
t _{d(off)}	Turn-Off Time			20	30	
t _f				15	25	

Typical Performance Characteristics

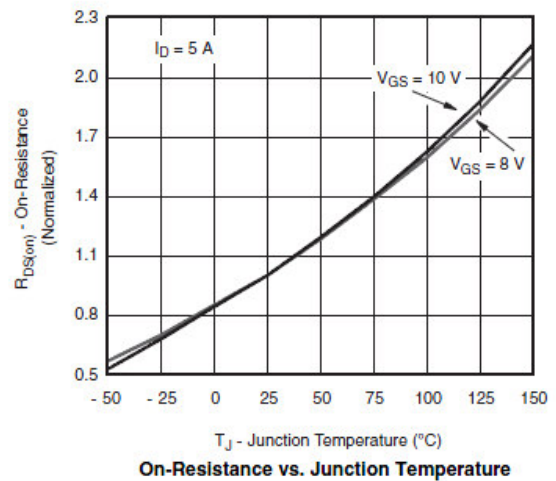
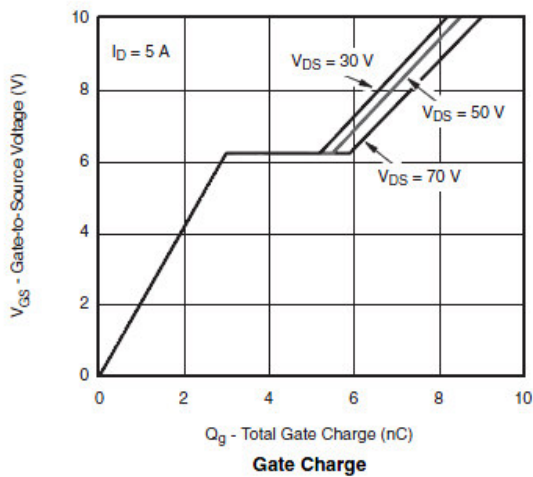
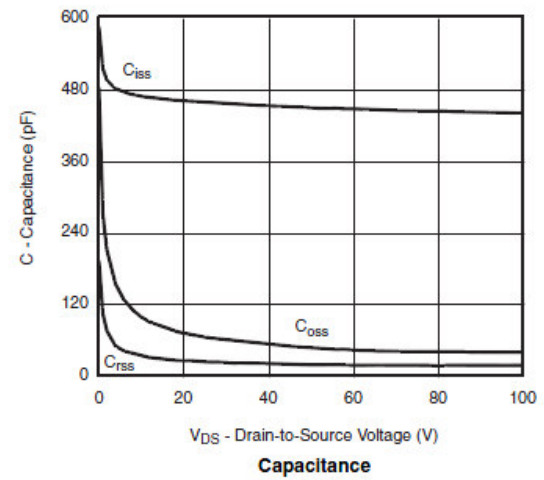
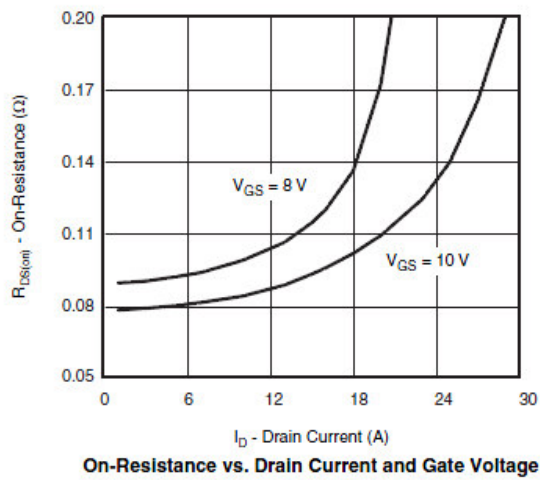
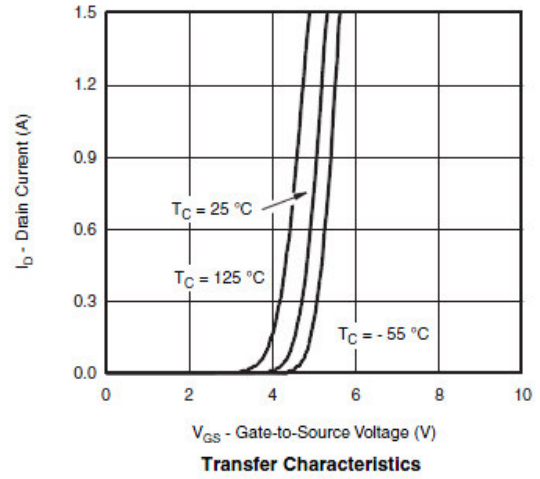
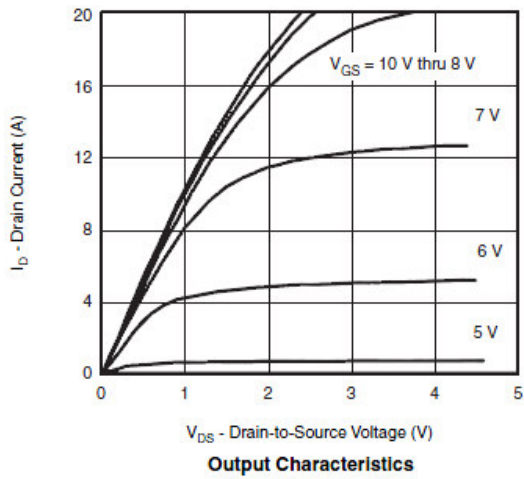

Typical Performance Characteristics (continue)

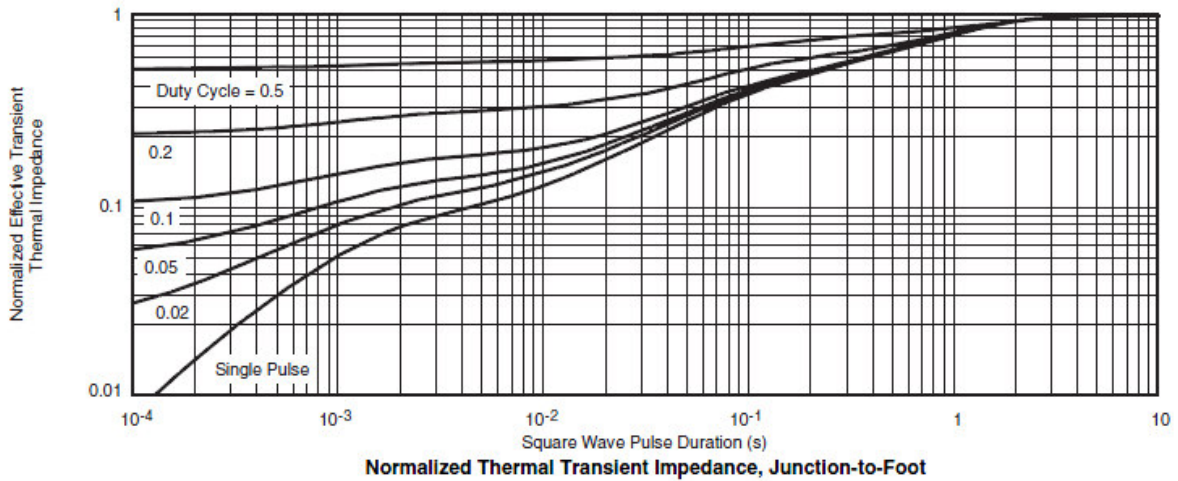
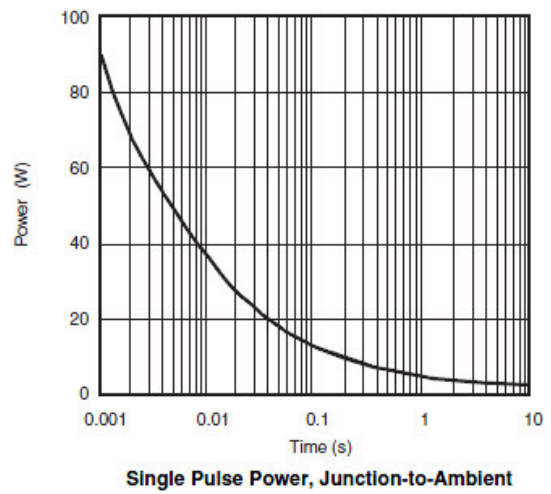
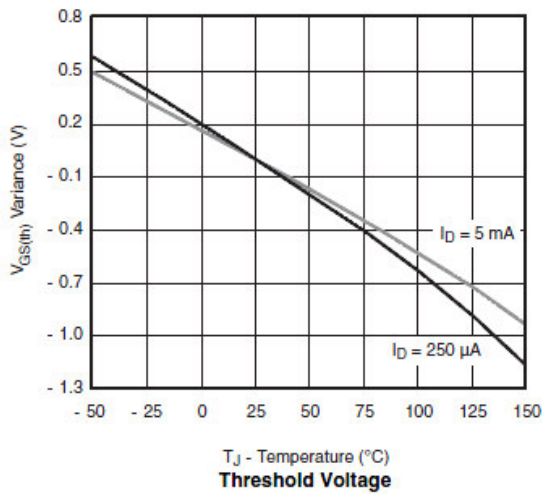
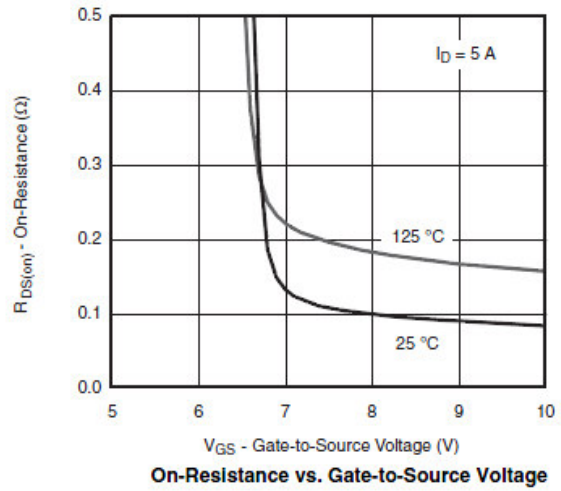
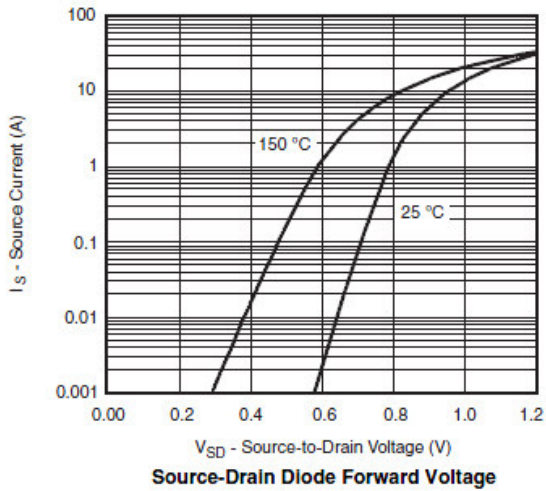

Typical Performance Characteristics (continue)

Gate Charge Test Circuit & Waveform

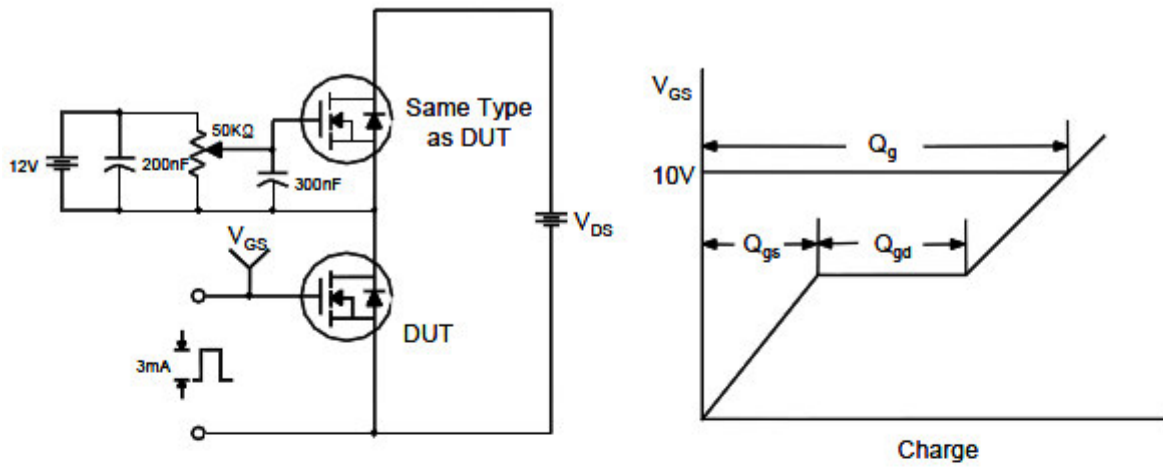

Resistive Switching Test Circuit & Waveforms

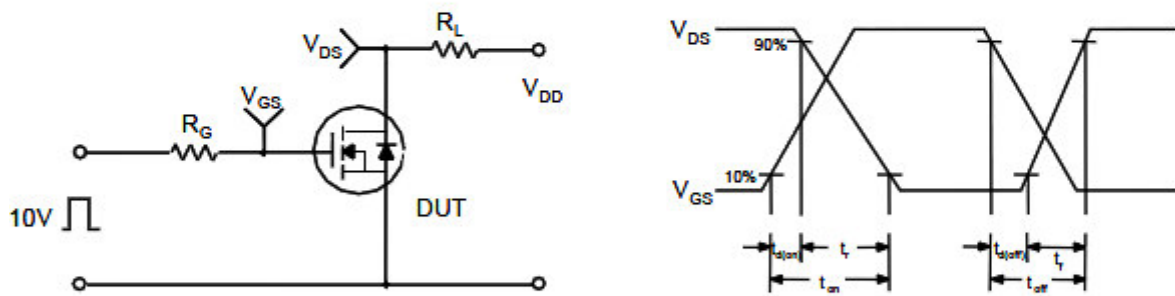

Unclamped Inductive Switching Test Circuit & Waveforms

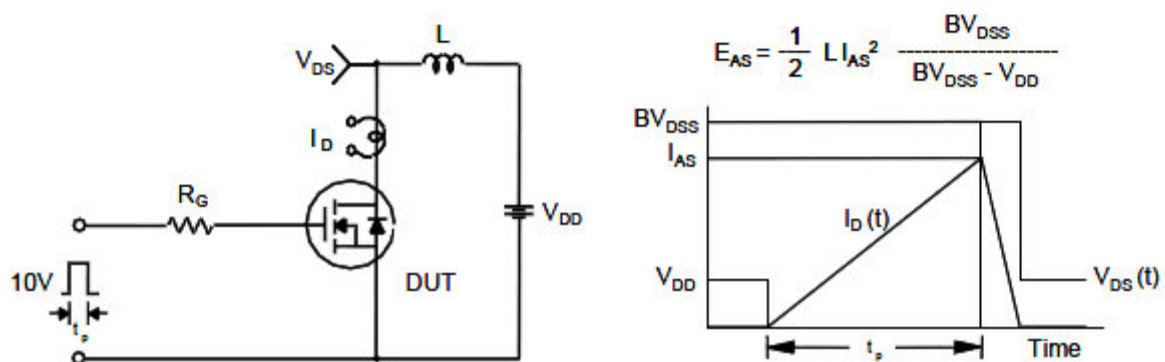

Package Dimension

SOT-89-3L

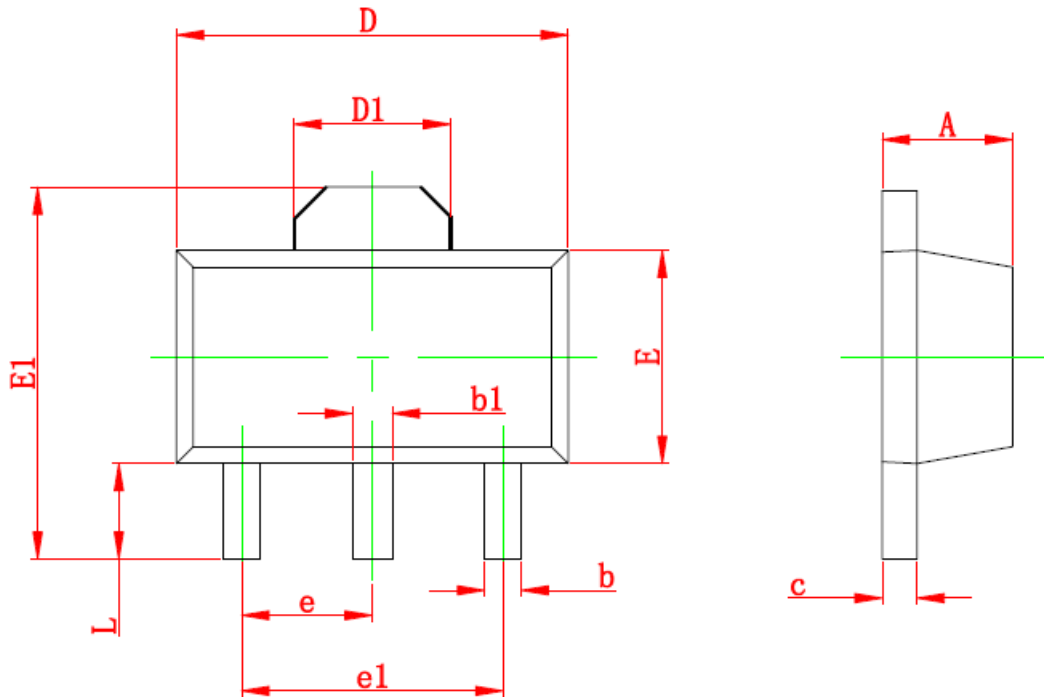





Dimensions				
Symbol	Millimeters		Inches	
	Min	Max	Min	Max
A	1.400	1.600	0.055	0.063
b	0.320	0.520	0.013	0.197
b1	0.400	0.580	0.016	0.023
c	0.350	0.440	0.014	0.017
D	4.400	4.600	0.173	0.181
D1	1.550 (REF)		0.061 (REF)	
E	2.30	2.600	0.091	0.102
E1	3.940	4.250	0.155	0.167
e	1.50 (TYP)		0.060 (TYP)	
e1	3.00 (TYP)		0.118 (TYP)	
L	0.900 (TYP)	1.200	0.035	0.047



NOTICE

Information furnished is believed to be accurate and reliable. However Globaltech Semiconductor assumes no responsibility for the consequences of use of such information nor for any infringement of patents or other rights of third parties, which may result from its use. No license is granted by implication or otherwise under any patent or patent rights of Globaltech Semiconductor. Specifications mentioned in this publication are subject to change without notice. This publication supersedes and replaces all information without express written approval of Globaltech Semiconductor.

CONTACT US

GS Headquarter	
	4F.,No.431,Lane11,Sec.6,Minquan E.Rd Neihu District Taipei City 114, Taiwan (R.O.C)
	886226579980
	886226573630
	sales_twn@gspower.com

WuXi Branch	
	No.21 Changjiang Rd., WND, Wuxi, Jiangsu, China (INFO. & TECH. Science Park Building A 210 Room)
	8651085217051
	8651085211238
	sales_cn@gspower.com

RD Division	
	824 Bolton Drive Milpitas. CA. 95035
	14084570587