

# GSM8918

## 40V N-Channel Enhancement Mode MOSFET

### Product Description

GSM8918, N-Channel enhancement mode MOSFET, uses Advanced Trench Technology to provide excellent  $R_{DS(ON)}$ , low gate charge.

These devices are particularly suited for low voltage power management, and low in-line power loss are needed in commercial industrial surface mount applications.

### Features

- 40V/4.6A,  $R_{DS(ON)}=30m\Omega@V_{GS}=10V$
- 40V/3.6A,  $R_{DS(ON)}=54m\Omega@V_{GS}=4.5V$
- Super high density cell design for extremely low  $R_{DS(ON)}$
- SOT-89-3L package design

### Applications

- Motor and Load Control
- Power Management in White LED System
- DC-DC System
- LCD Panel

### Packages & Pin Assignments

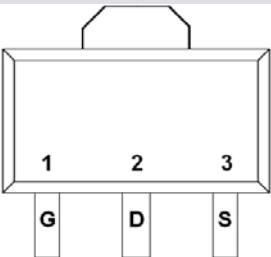
GSM8918YF(SOT-89-3L)	
	
Pin	Description
1	Gate
2	Drain
3	Source

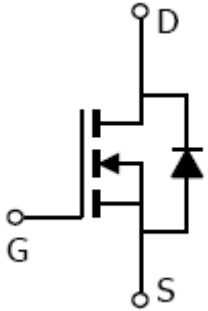

## Ordering Information

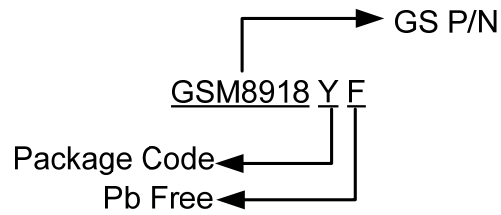

Part Number	Package	Quantity Reel
GSM8918YF	SOT-89-3L	1000 PCS

## Marking Information

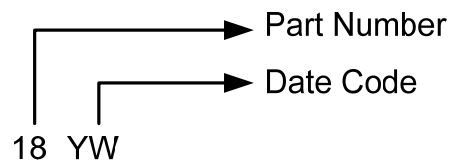

## Absolute Maximum Ratings

$T_A=25^\circ\text{C}$  Unless otherwise noted

Symbol	Parameter	Typical	Unit	
$V_{DSS}$	Drain-Source Voltage	40	V	
$V_{GSS}$	Gate –Source Voltage	$\pm 20$	V	
$I_D$	Continuous Drain Current( $T_J=150^\circ\text{C}$ )	$T_A = 25^\circ\text{C}$	4.6	A
		$T_A = 70^\circ\text{C}$	3.6	
$I_{DM}$	Pulsed Drain Current	10	A	
$I_S$	Continuous Source Current(Diode Conduction)	1.6	A	
$P_D$	Power Dissipation	$T_A = 25^\circ\text{C}$	1.45	W
		$T_A = 70^\circ\text{C}$	0.6	
$T_J$	Operating Junction Temperature	150	$^\circ\text{C}$	
$T_{STG}$	Storage Temperature Range	-55 to 150	$^\circ\text{C}$	
$R_{\theta JA}$	Thermal Resistance-Junction to Ambient	120	$^\circ\text{C/W}$	

## Electrical Characteristics

T<sub>A</sub>=25°C Unless otherwise noted

Symbol	Parameter	Conditions	Min	Typ	Max	Unit
<b>Static</b>						
V <sub>(BR)DSS</sub>	Drain-Source Breakdown Voltage	V <sub>GS</sub> =0V, I <sub>D</sub> = 250uA	40			V
V <sub>GS(th)</sub>	Gate Threshold Voltage	V <sub>DS</sub> =V <sub>GS</sub> , I <sub>D</sub> = 250uA	1.5		3.0	
I <sub>GSS</sub>	Gate Leakage Current	V <sub>DS</sub> =0V, V <sub>GS</sub> = ±20V			±100	nA
I <sub>DSS</sub>	Zero Gate Voltage Drain Current	V <sub>DS</sub> = 40V, V <sub>GS</sub> =0V			1	uA
		V <sub>DS</sub> =40V, V <sub>GS</sub> =0V, T <sub>J</sub> =85°C			10	
I <sub>D(on)</sub>	On-State Drain Current	V <sub>DS</sub> ≥ 5V, V <sub>GS</sub> = 10V	20			A
R <sub>DS(on)</sub>	Drain-Source On-Resistance	V <sub>GS</sub> = 10V, I <sub>D</sub> = 4.6A		24	30	mΩ
		V <sub>GS</sub> = 4.5V, I <sub>D</sub> = 3.6A		42	54	
g <sub>FS</sub>	Forward Transconductance	V <sub>DS</sub> = 15V, I <sub>D</sub> = 5.0A		25		S
V <sub>SD</sub>	Diode Forward Voltage	I <sub>S</sub> = 2A, V <sub>GS</sub> =0V		0.85	1.2	V
<b>Dynamic</b>						
Q <sub>g</sub>	Total Gate Charge	V <sub>DS</sub> =20V, V <sub>GS</sub> =4.5V, I <sub>D</sub> =3A		10	14	nC
Q <sub>gs</sub>	Gate-Source Charge			2.8		
Q <sub>gd</sub>	Gate-Drain Charge			3.2		
C <sub>iss</sub>	Input Capacitance	V <sub>DS</sub> =20V, V <sub>GS</sub> =0V, f=1MHz		850		pF
C <sub>oss</sub>	Output Capacitance			110		
C <sub>rss</sub>	Reverse Transfer Capacitance			75		
t <sub>d(on)</sub>	Turn-On Time	V <sub>DD</sub> =20V, R <sub>L</sub> =4Ω, I <sub>D</sub> =3.0A, V <sub>GEN</sub> =10V, R <sub>G</sub> =1Ω		6	12	ns
t <sub>r</sub>				10	20	
t <sub>d(off)</sub>	Turn-Off Time			20	36	
t <sub>f</sub>				6	12	

## Typical Performance Characteristics

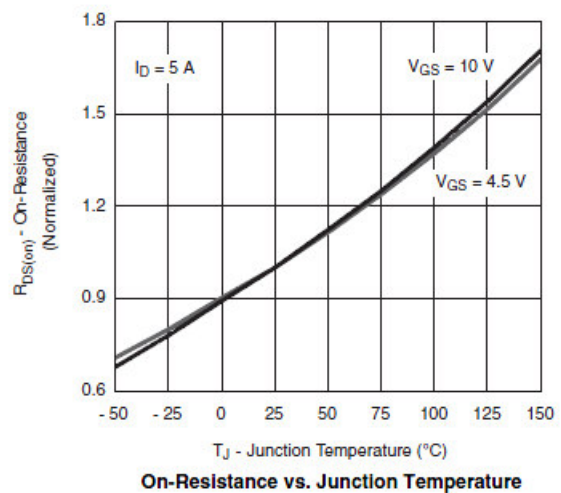
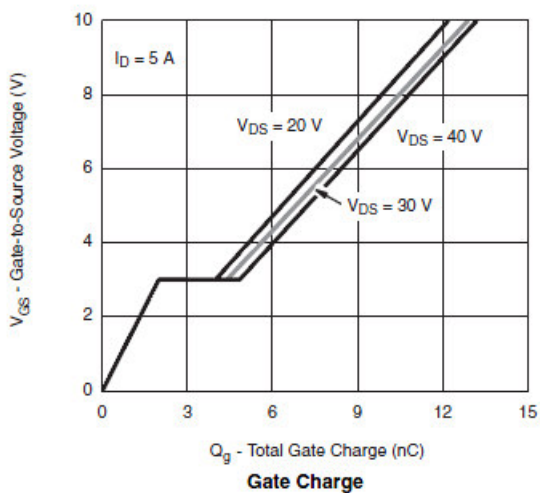
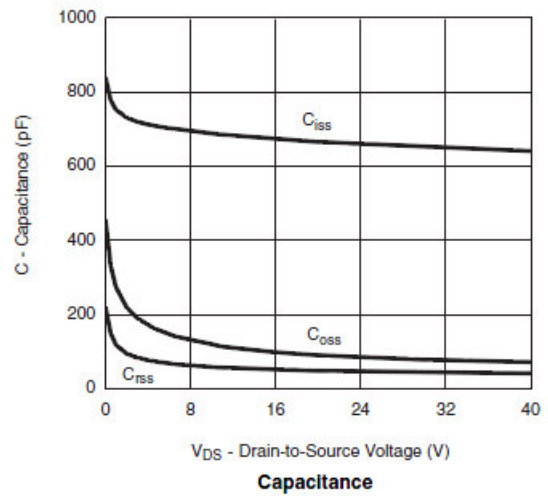
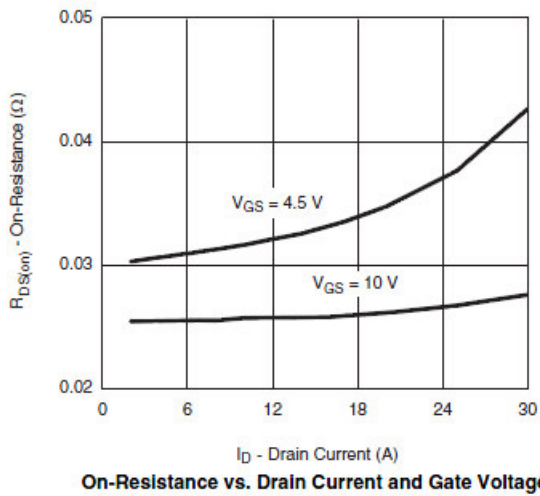
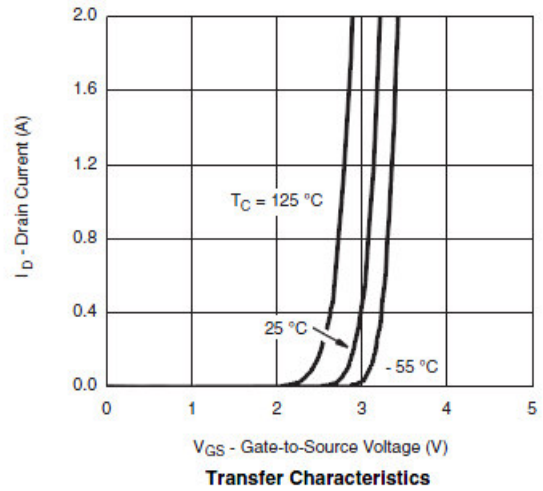
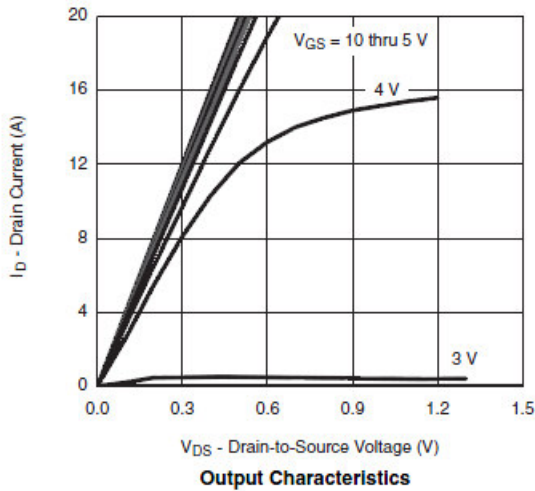

## Typical Performance Characteristics (continue)

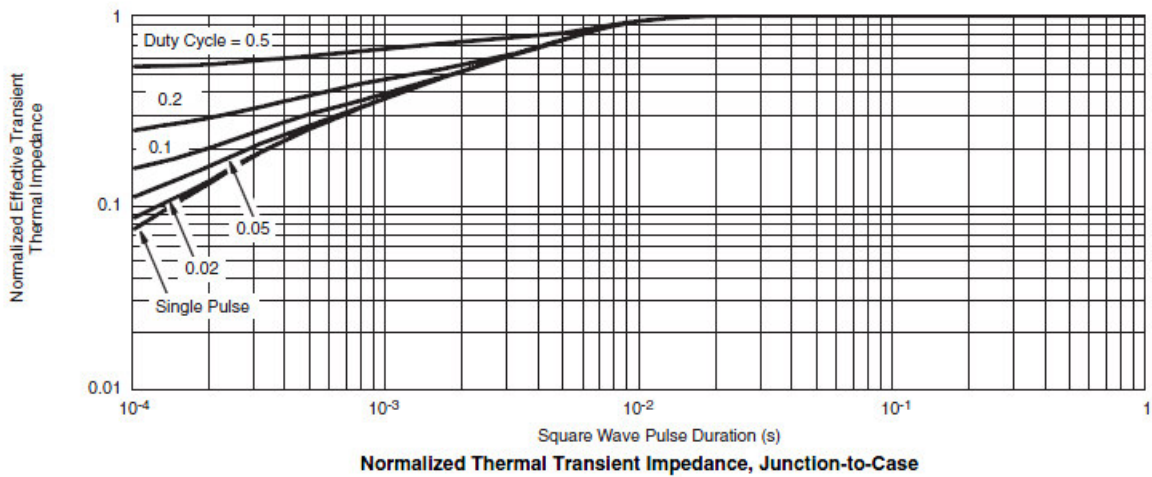
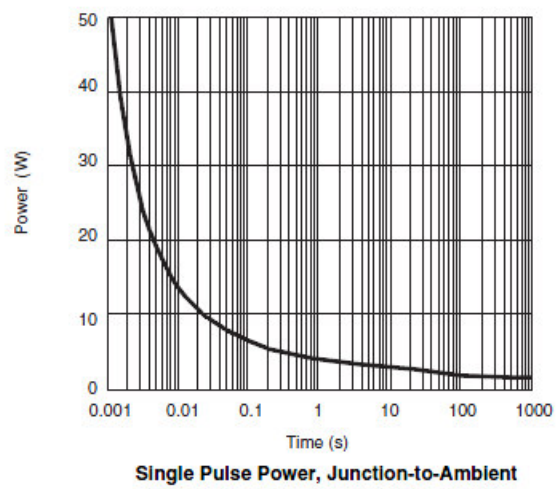
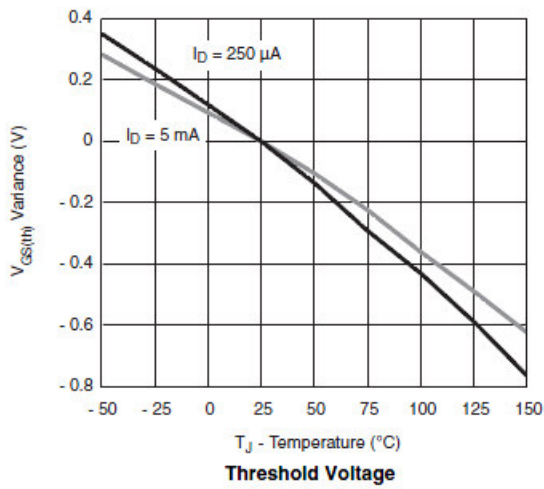
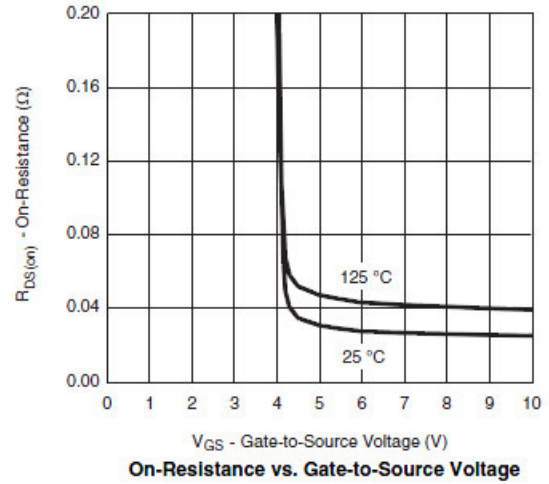
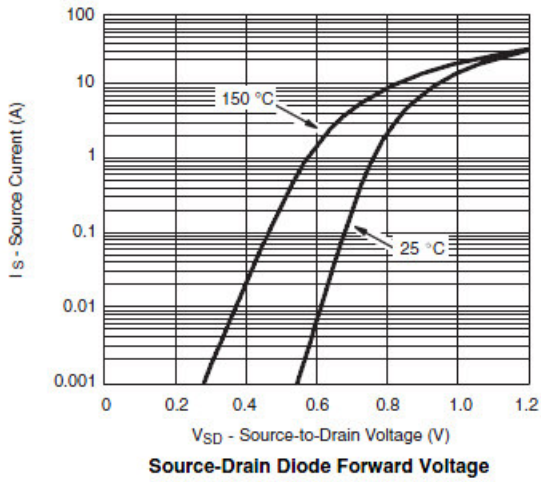

## Typical Performance Characteristics (continue)

### Gate Charge Test Circuit & Waveform

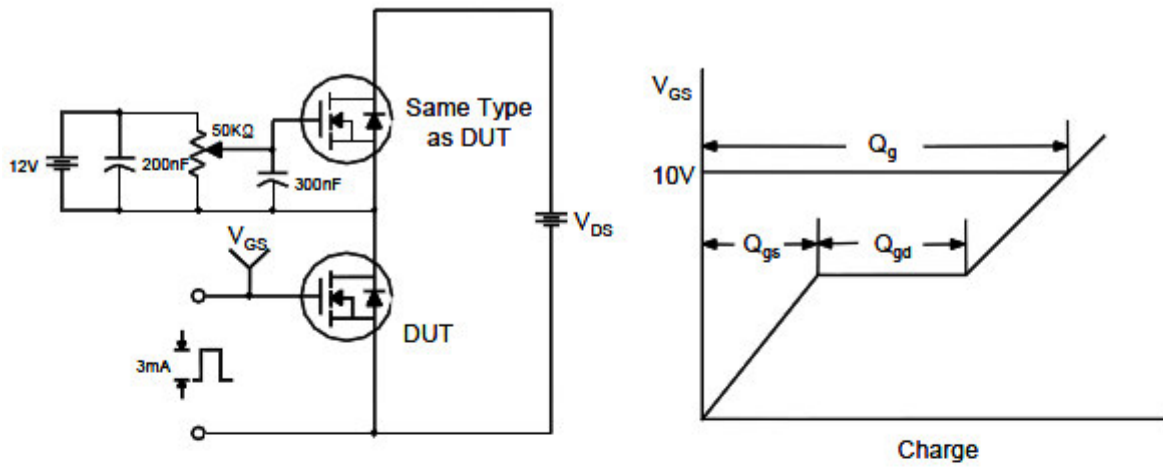

### Resistive Switching Test Circuit & Waveforms

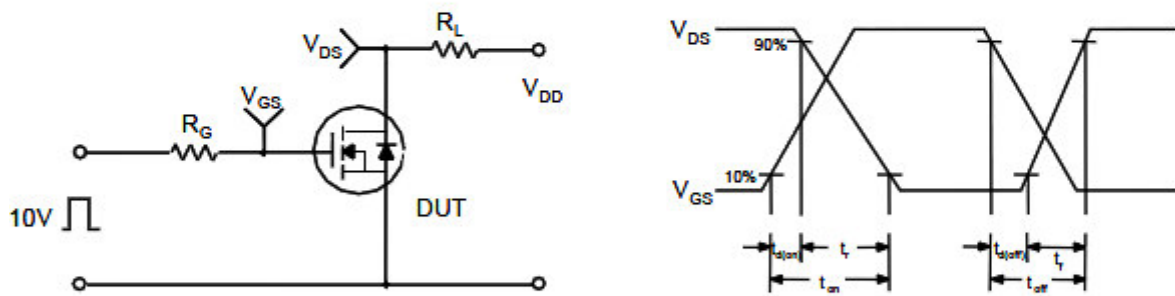

### Unclamped Inductive Switching Test Circuit & Waveforms

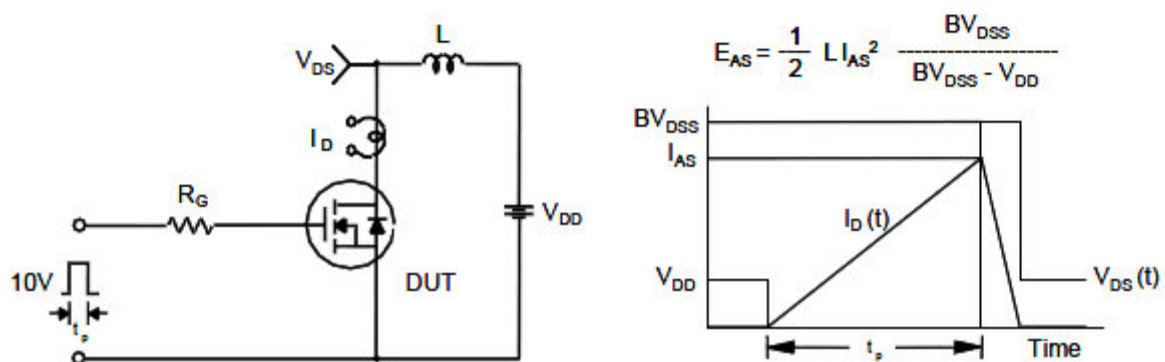

Package Dimension

SOT-89-3L

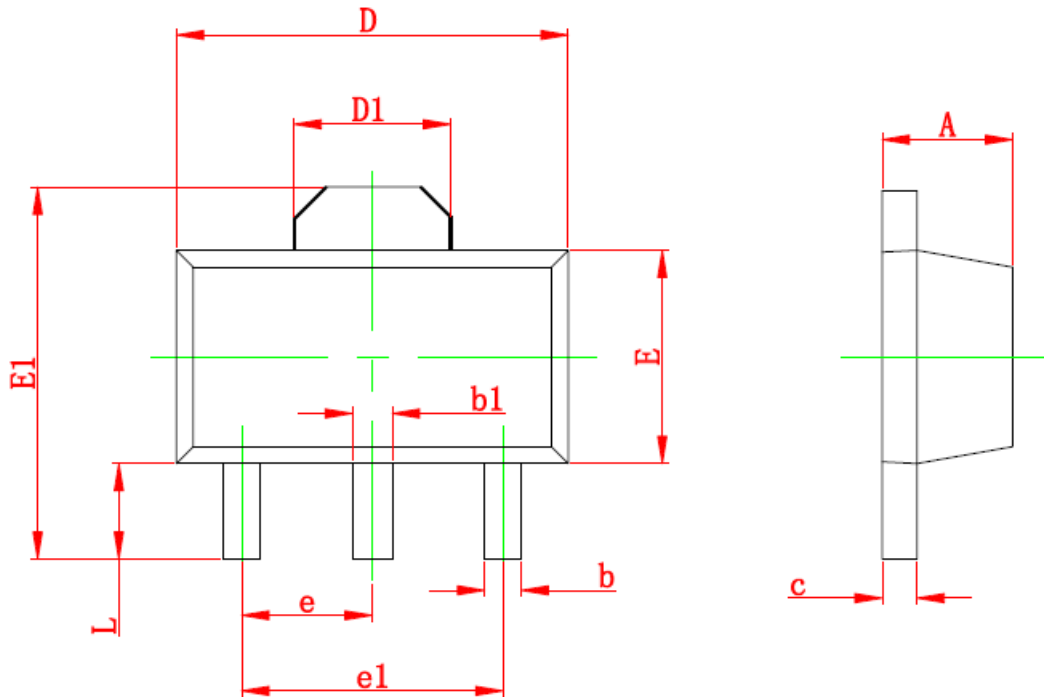





Dimensions				
Symbol	Millimeters		Inches	
	Min	Max	Min	Max
A	1.400	1.600	0.055	0.063
b	0.320	0.520	0.013	0.197
b1	0.400	0.580	0.016	0.023
c	0.350	0.440	0.014	0.017
D	4.400	4.600	0.173	0.181
D1	1.550 (REF)		0.061 (REF)	
E	2.30	2.600	0.091	0.102
E1	3.940	4.250	0.155	0.167
e	1.50 (TYP)		0.060 (TYP)	
e1	3.00 (TYP)		0.118 (TYP)	
L	0.900 (TYP)	1.200	0.035	0.047



## NOTICE

Information furnished is believed to be accurate and reliable. However Globaltech Semiconductor assumes no responsibility for the consequences of use of such information nor for any infringement of patents or other rights of third parties, which may result from its use. No license is granted by implication or otherwise under any patent or patent rights of Globaltech Semiconductor. Specifications mentioned in this publication are subject to change without notice. This publication supersedes and replaces all information without express written approval of Globaltech Semiconductor.

## CONTACT US

GS Headquarter	
	4F.,No.431,Lane11,Sec.6,Minquan E.Rd Neihu District Taipei City 114, Taiwan (R.O.C)
	886226579980
	886226573630
	sales_twn@gspower.com

WuXi Branch	
	No.21 Changjiang Rd., WND, Wuxi, Jiangsu, China (INFO. & TECH. Science Park Building A 210 Room)
	8651085217051
	8651085211238
	sales_cn@gspower.com

RD Division	
	824 Bolton Drive Milpitas. CA. 95035
	14084570587