

GSM4946W

60V N-Channel Enhancement Mode MOSFET

Product Description

GSM4946W, N-Channel enhancement mode MOSFET, uses Advanced Trench Technology to provide excellent $R_{DS(ON)}$, low gate charge.

These devices are particularly suited for low voltage power management, and low in-line power loss are needed in commercial industrial surface mount applications.

Features

- 60V/6.8A, $R_{DS(ON)}=42m\Omega@V_{GS}=10V$
- 60V/5.6A, $R_{DS(ON)}=48m\Omega@V_{GS}=4.5V$
- Super high density cell design for extremely low $R_{DS(ON)}$
- SOP-8P package design

Applications

- Motor and Load Control
- AD/DC Inverter Systems.
- Power Management in White LED System

Packages & Pin Assignments

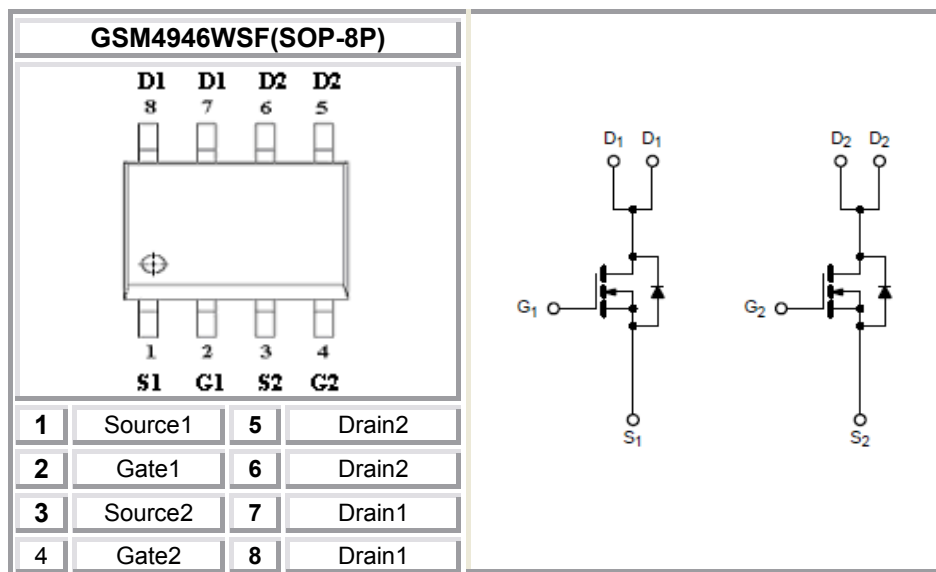

Ordering Information

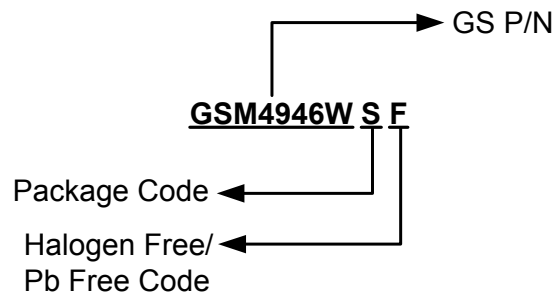

Part Number	Package	Quantity Reel
GSM4946WSF	SOP-8P	2500 PCS

Marking Information

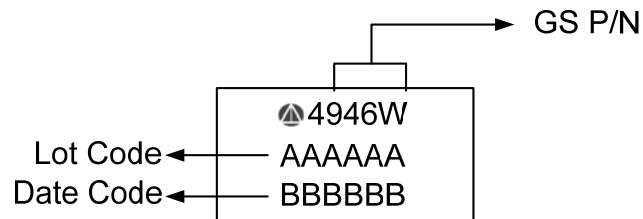

Absolute Maximum Ratings

($T_A=25^\circ\text{C}$ unless otherwise noted)

Symbol	Parameter	Typical	Unit
V_{DSS}	Drain-Source Voltage	60	V
V_{GSS}	Gate-Source Voltage	± 20	V
I_D	Continuous Drain Current($T_J=150^\circ\text{C}$)	$T_A=25^\circ\text{C}$	6.8
		$T_A=70^\circ\text{C}$	5.6
I_{DM}	Pulsed Drain Current	30	A
I_S	Continuous Source Current(Diode Conduction)	1.5	A
P_D	Power Dissipation	$T_A=25^\circ\text{C}$	2.8
		$T_A=70^\circ\text{C}$	1.8
T_J	Operating Junction Temperature	150	$^\circ\text{C}$
T_{STG}	Storage Temperature Range	-55/150	$^\circ\text{C}$
$R_{\theta JA}$	Thermal Resistance-Junction to Ambient	62.5	$^\circ\text{C}/\text{W}$

Electrical Characteristics

($T_A=25^\circ\text{C}$ unless otherwise noted)

Symbol	Parameter	Conditions	Min	Typ	Max	Unit
Static						
$V_{(BR)DSS}$	Drain-Source Breakdown Voltage	$V_{GS}=0V, I_D=250\mu A$	60			V
$V_{GS(th)}$	Gate Threshold Voltage	$V_{DS}=V_{GS}, I_D=250\mu A$	1.0		2.5	
I_{GSS}	Gate Leakage Current	$V_{DS}=0V, V_{GS}=\pm 20V$			± 100	nA
I_{DSS}	Zero Gate Voltage Drain Current	$V_{DS}=60V, V_{GS}=0V$			1	μA
		$V_{DS}=60V, V_{GS}=0V, T_J=85^\circ\text{C}$			5	
$I_{D(on)}$	On-State Drain Current	$V_{DS} \geq 5V, V_{GS}=4.5V$	30			A
$R_{DS(on)}$	Drain-Source On-Resistance	$V_{GS}=10V, I_D=6.8A$		38	42	m Ω
		$V_{GS}=4.5V, I_D=5.6A$		42	48	
g_{FS}	Forward Transconductance	$V_{DS}=15V, I_D=5.3A$		24		S
V_{SD}	Diode Forward Voltage	$I_S=2.0A, V_{GS}=0V$		0.8	1.2	V
Dynamic						
C_{iss}	Input Capacitance	$V_{DS}=30V, V_{GS}=0V, f=1\text{MHz}$		890		pF
C_{oss}	Output Capacitance			85		
C_{rss}	Reverse Transfer Capacitance			48		
Q_g	Total Gate Charge	$V_{DS}=30V, V_{GS}=5V, I_D=5.6A$		10	15	nC
Q_{gs}	Gate-Source Charge			3.5		
Q_{gd}	Gate-Drain Charge			3.6		
$t_{d(on)}$	Turn-On Time	$V_{DD}=30V, R_L=6.8\Omega, I_D=5.0A, V_{GEN}=4.5V, R_G=6\Omega$		10	15	ns
T_r				12	20	
$t_{d(off)}$	Turn-Off Time			25	35	
T_f				10	15	

Typical Performance Characteristics

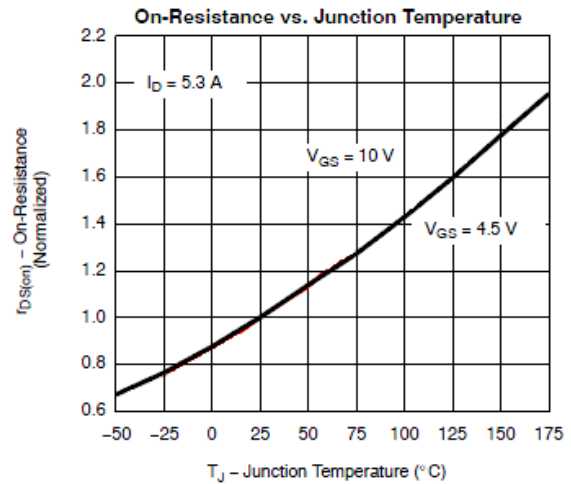
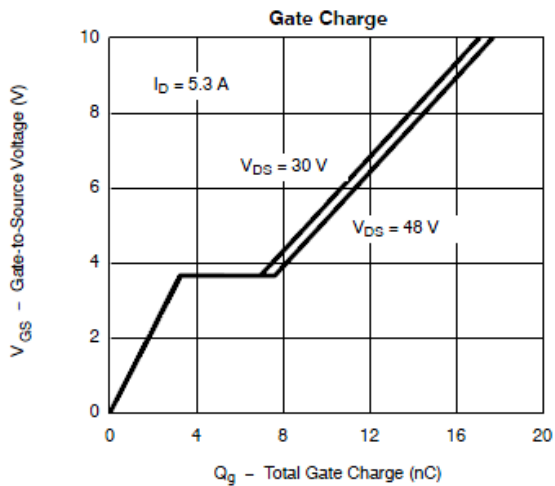
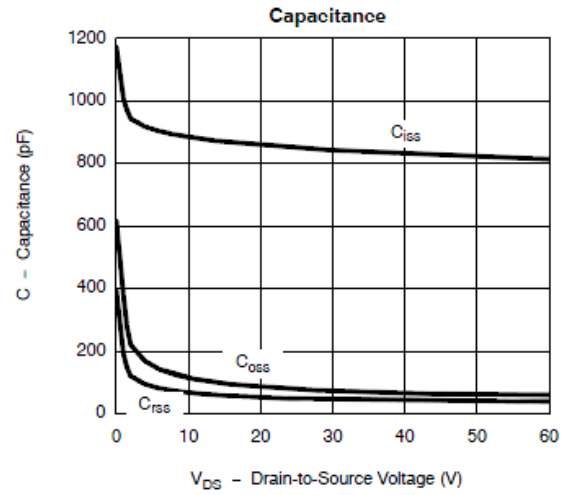
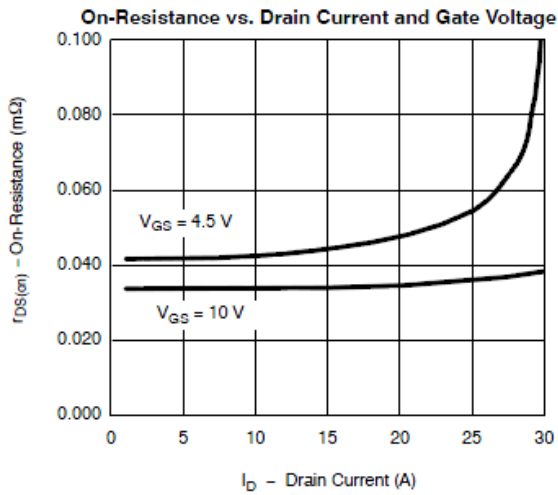
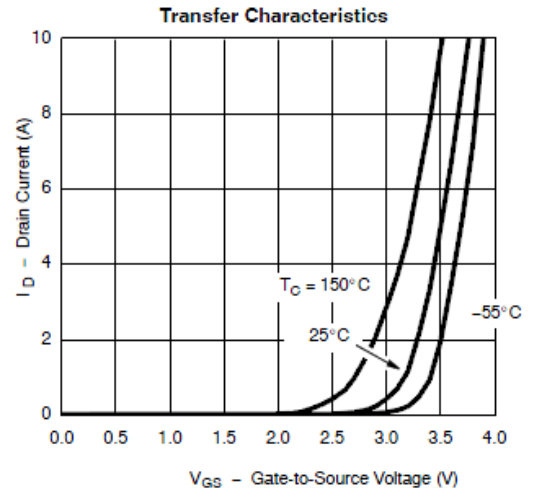
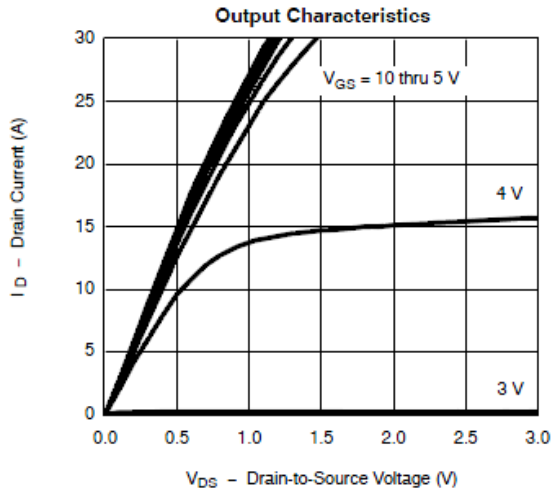

Typical Performance Characteristics (continue)

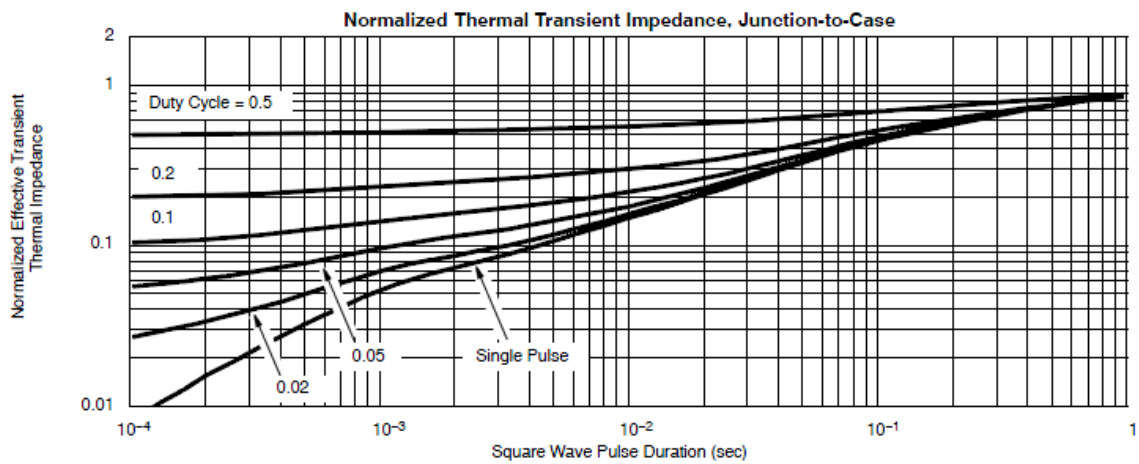
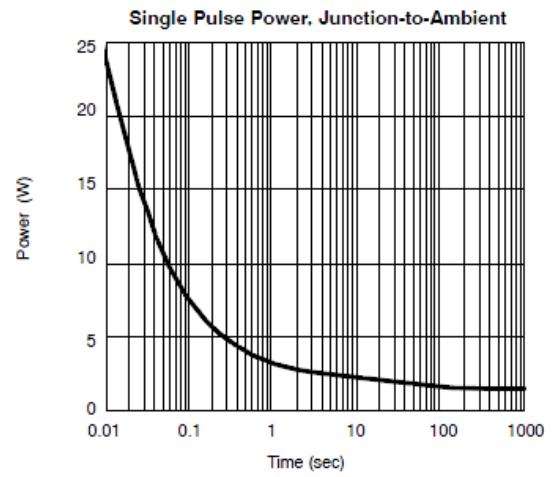
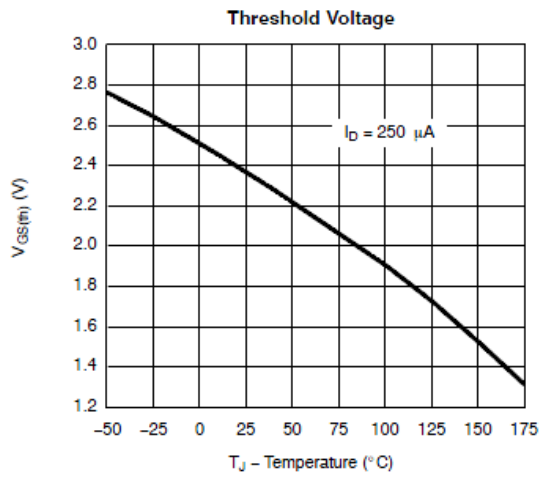
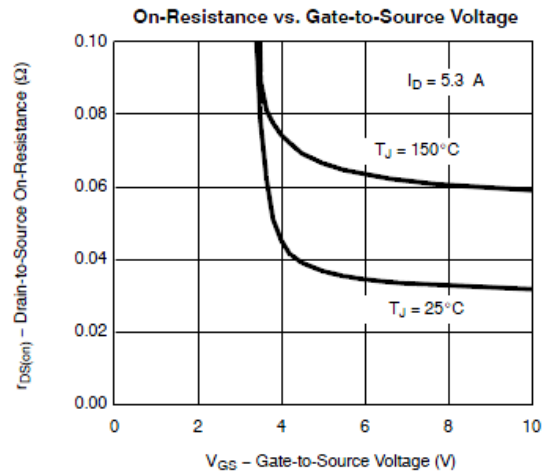
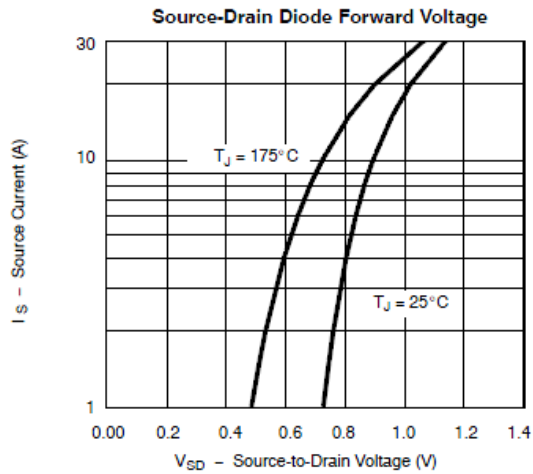

Typical Characteristics

Gate Charge Test Circuit & Waveform

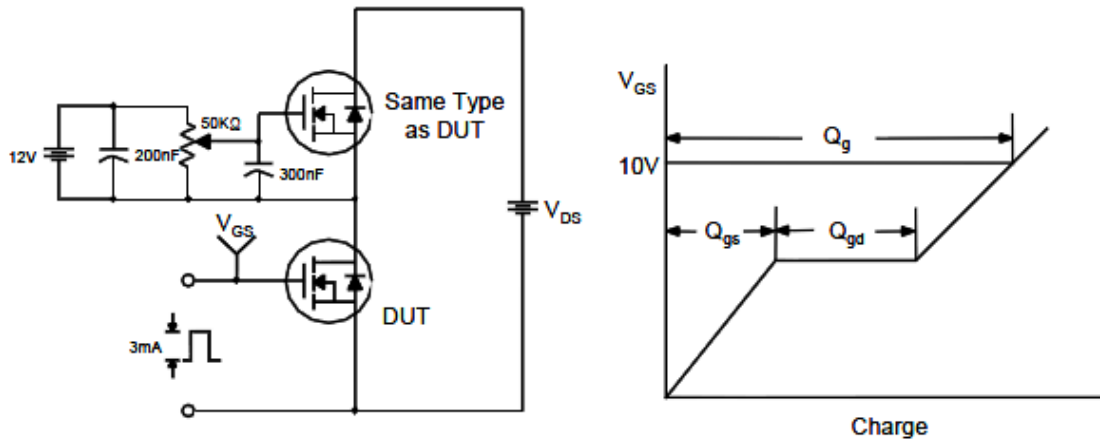

Resistive Switching Test Circuit & Waveforms

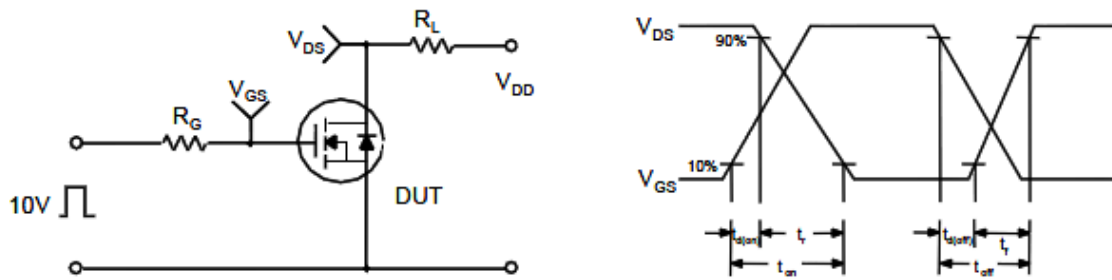

Unclamped Inductive Switching Test Circuit & Waveforms

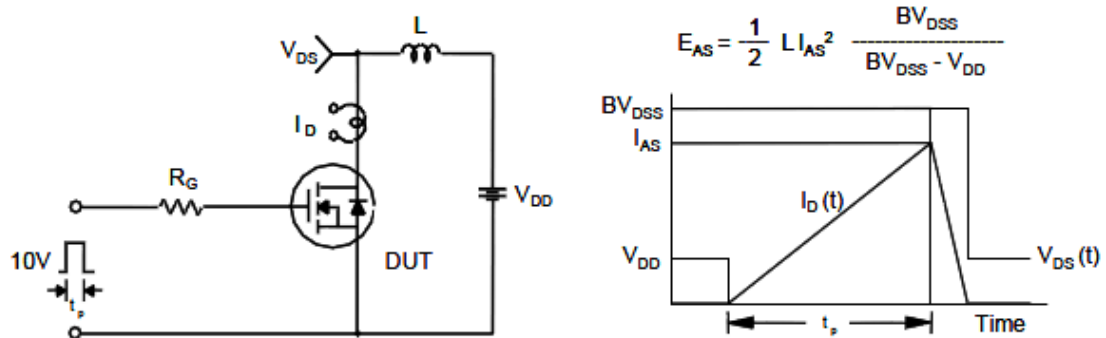

Package Dimension

SOP-8P PLASTIC PACKAGE

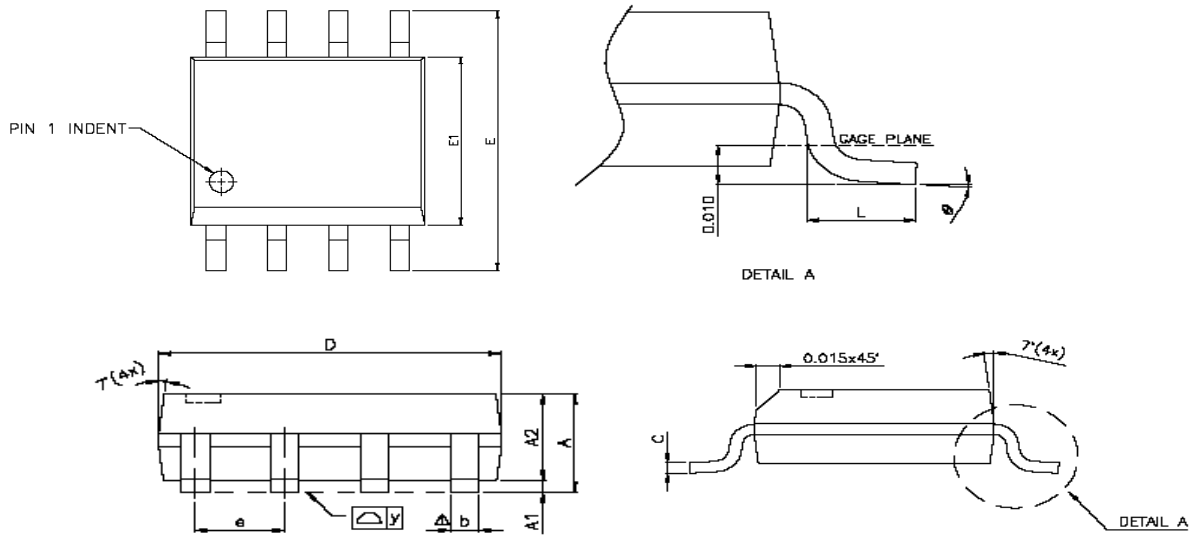









Dimensions						
SYMBOL	Millimeters			Inches		
	MIN	NOM	MAX	MIN	NOM	MAX
A	1.47	1.60	1.73	0.058	0.063	0.068
A1	0.10	-	0.25	0.004	-	0.010
A2	-	1.45	-	-	0.057	-
b	0.33	0.41	0.51	0.013	0.016	0.020
C	0.19	0.20	0.25	0.0075	0.008	0.0098
D	4.80	4.85	4.95	0.189	0.191	0.195
E	5.80	6.00	6.20	0.228	0.236	0.244
E1	3.80	3.90	4.00	0.150	0.154	0.157
e	-	1.27	-	-	0.050	-
L	0.38	0.71	1.27	0.015	0.028	0.050
Δy	-	-	0.076	-	-	0.003
θ	0°	-	8°	0°	-	8°



NOTICE

Information furnished is believed to be accurate and reliable. However Globaltech Semiconductor assumes no responsibility for the consequences of use of such information nor for any infringement of patents or other rights of third parties, which may result from its use. No license is granted by implication or otherwise under any patent or patent rights of Globaltech Semiconductor. Specifications mentioned in this publication are subject to change without notice. This publication supersedes and replaces all information without express written approval of Globaltech Semiconductor.

CONTACT US

GS Headquarter	
	4F.,No.43-1,Lane11,Sec.6,Minquan E.Rd Neihu District Taipei City 114, Taiwan (R.O.C)
	886-2-2657-9980
	886-2-2657-3630
	sales_twn@gs-power.com

Wu-Xi Branch	
	No.21 Changjiang Rd., WND, Wuxi, Jiangsu, China (INFO. &. TECH. Science Park Building A 210 Room)
	86-510-85217051
	86-510-85211238
	sales_cn@gs-power.com

RD Division	
	824 Bolton Drive Milpitas. CA. 95035
	1-408-457-0587