

GSM3432

30V N-Channel Enhancement Mode MOSFET

Product Description

GSM3432, N-Channel enhancement mode MOSFET, uses Advanced Trench Technology to provide excellent $R_{DS(ON)}$, low gate charge.

These devices are particularly suited for low voltage power management, such as smart phone and notebook computer and other battery powered circuits, and low in-line power loss are needed in commercial industrial surface mount applications.

Features

- 30V/3.6A, $R_{DS(ON)}=75m\Omega@V_{GS}=10V$
- 30V/3.0A, $R_{DS(ON)}=80m\Omega@V_{GS}=4.5V$
- 30V/2.2A, $R_{DS(ON)}=100m\Omega@V_{GS}=2.5V$
- Super high density cell design for extremely low $R_{DS(ON)}$
- Exceptional on-resistance and maximum DC current capability
- TSOP-6 package design

Applications

- Portable Equipment
- Battery Powered System
- Net Working System

Packages & Pin Assignments

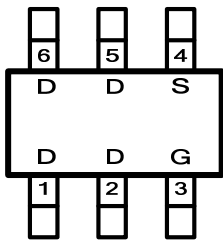
GSM3432TSF(TSOP-6)	
	
Pin	Description
1	Drain
2	Drain
3	Gate
4	Source
5	Drain
6	Drain

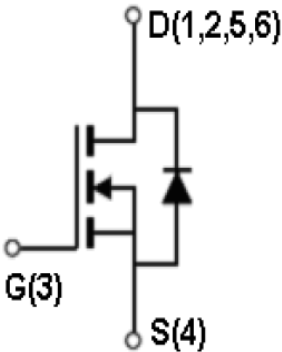

Ordering Information

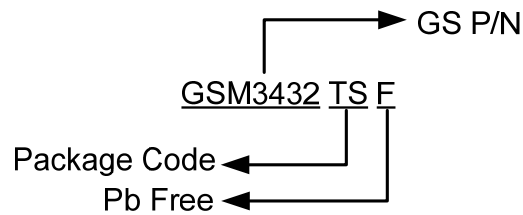

Part Number	Package	Quantity Reel
GSM3432TSF	TSOP-6	3000 PCS

Marking Information

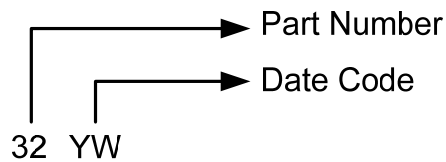

Absolute Maximum Ratings

$T_A=25^{\circ}\text{C}$, unless otherwise noted

Symbol	Parameter	Typical	Unit	
V_{DSS}	Drain-Source Voltage	30	V	
V_{GSS}	Gate-Source Voltage	± 12	V	
I_D	Continuous Drain Current($T_J=150^{\circ}\text{C}$)	$T_A=25^{\circ}\text{C}$	3.6	A
		$T_A=70^{\circ}\text{C}$	3.0	
I_{DM}	Pulsed Drain Current	20	A	
I_S	Continuous Source Current(Diode Conduction)	1.6	A	
P_D	Power Dissipation	$T_A=25^{\circ}\text{C}$	2.0	W
		$T_A=70^{\circ}\text{C}$	1.3	
T_J	Operating Junction Temperature	150	$^{\circ}\text{C}$	
T_{STG}	Storage Temperature Range	-55/150	$^{\circ}\text{C}$	
$R_{\theta JA}$	Thermal Resistance-Junction to Ambient	120	$^{\circ}\text{C}/\text{W}$	

Electrical Characteristics

T_A=25°C, unless otherwise noted

Symbol	Parameter	Conditions	Min	Typ	Max	Unit
Static						
V _{(BR)DSS}	Drain-Source Breakdown Voltage	V _{GS} =0V, I _D =250uA	30			V
V _{GS(th)}	Gate Threshold Voltage	V _{DS} =V _{GS} , I _D =250uA	0.3		1.0	
I _{GSS}	Gate Leakage Current	V _{DS} =0V, V _{GS} =±12V			±100	nA
I _{DSS}	Zero Gate Voltage Drain Current	V _{DS} =24V, V _{GS} =0V			1	uA
		V _{DS} =24V, V _{GS} =0V, T _J =85°C			30	
I _{D(on)}	On-State Drain Current	V _{DS} ≥5V, V _{GS} =4.5V	30			A
R _{DS(on)}	Drain-Source On-Resistance	V _{GS} =10V, I _D =3.6A		65	75	mΩ
		V _{GS} =4.5V, I _D =3.0A		70	80	
		V _{GS} =2.5V, I _D =2.2A		90	100	
g _{FS}	Forward Transconductance	V _{DS} =10V, I _D =1.6A		20		S
V _{SD}	Diode Forward Voltage	I _S =1.7A, V _{GS} =0V		0.8	1.2	V
Dynamic						
Q _g	Total Gate Charge	V _{DS} =15V, V _{GS} =4.5V, I _D =3.6A		2.3	3	nC
Q _{gs}	Gate-Source Charge			1.0		
Q _{gd}	Gate-Drain Charge			0.6		
C _{iss}	Input Capacitance	V _{DS} =15V, V _{GS} =0V, f=1MHz		280		pF
C _{oss}	Output Capacitance			40		
C _{rss}	Reverse Transfer Capacitance			20		
t _{d(on)}	Turn-On Time	V _{DD} =15V, R _L =15Ω, I _D =1.0A, V _{GEN} =10V, R _G =6Ω		10	15	ns
t _r				12	20	
t _{d(off)}	Turn-Off Time			15	25	
t _f				10	15	

Typical Performance Characteristics

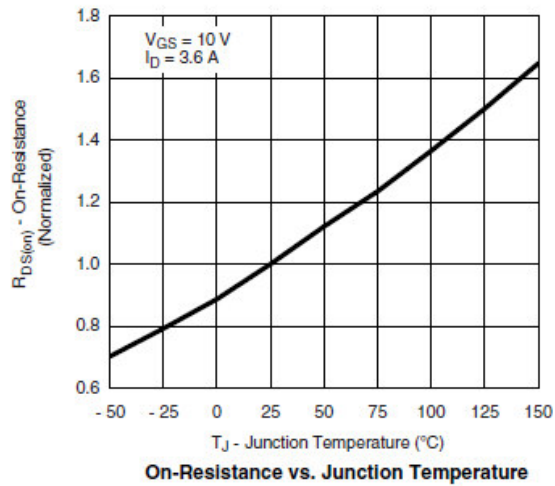
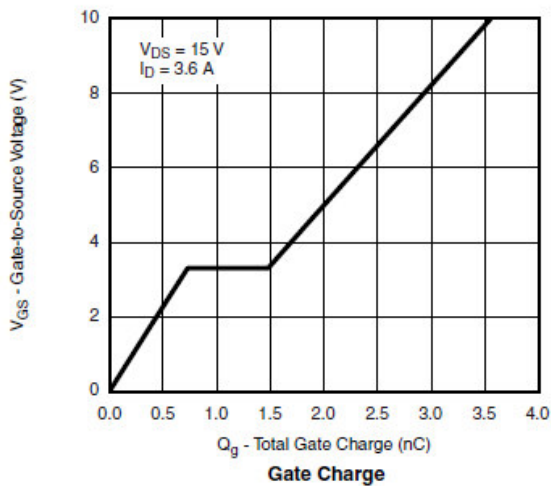
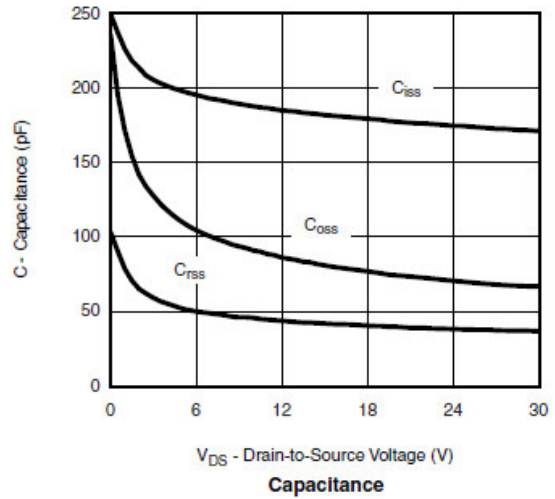
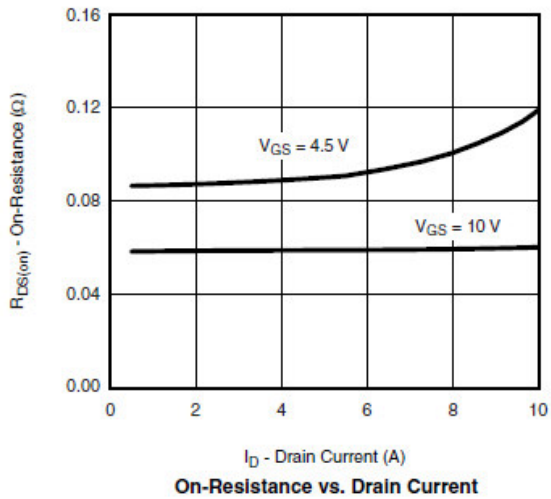
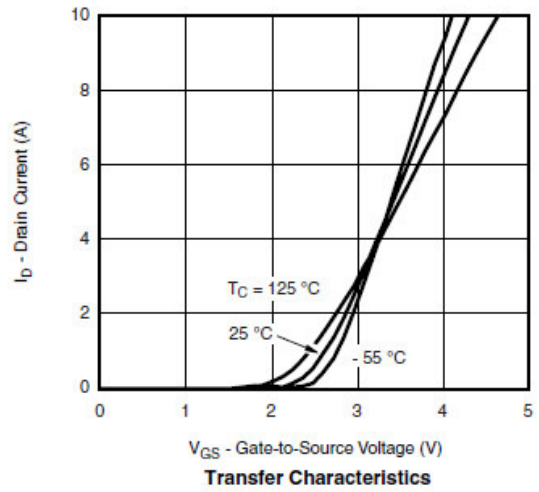
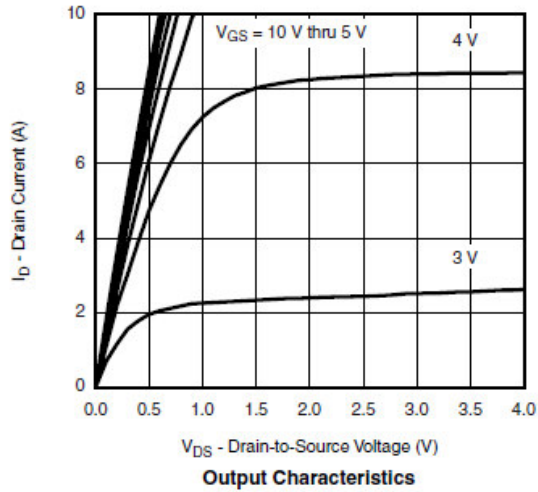

Typical Performance Characteristics (continue)

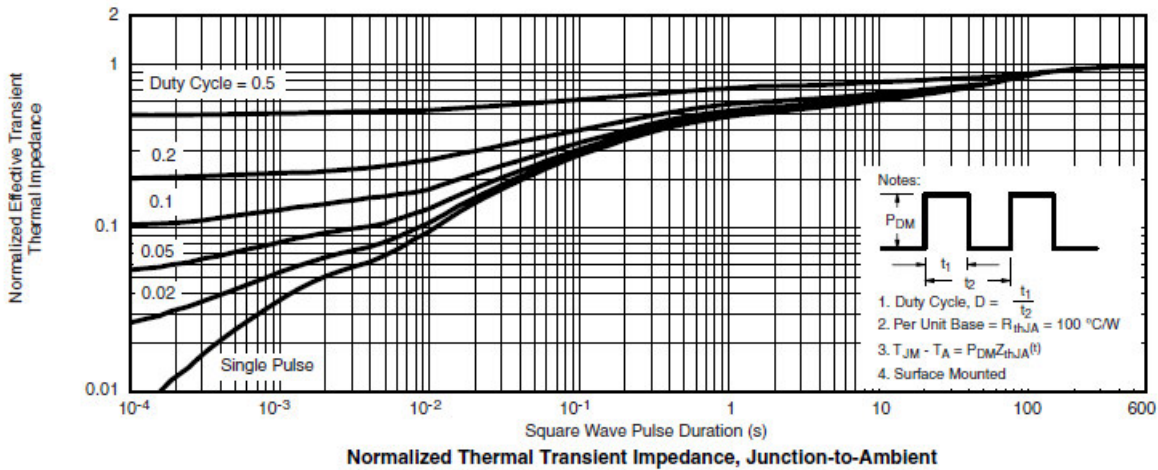
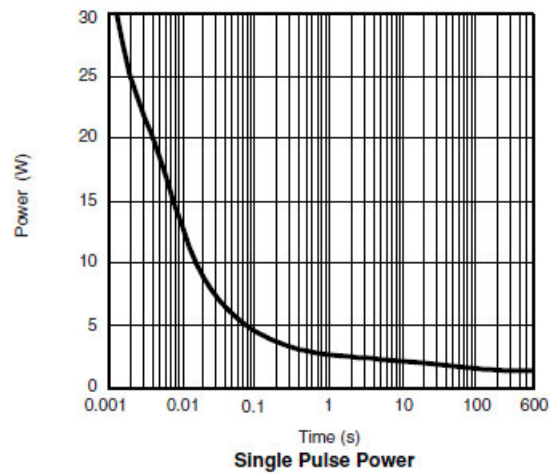
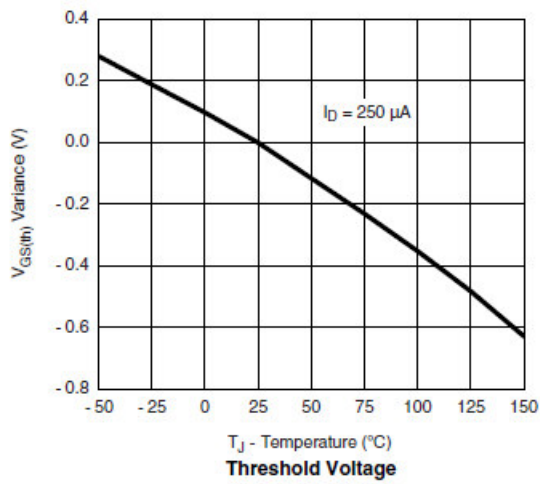
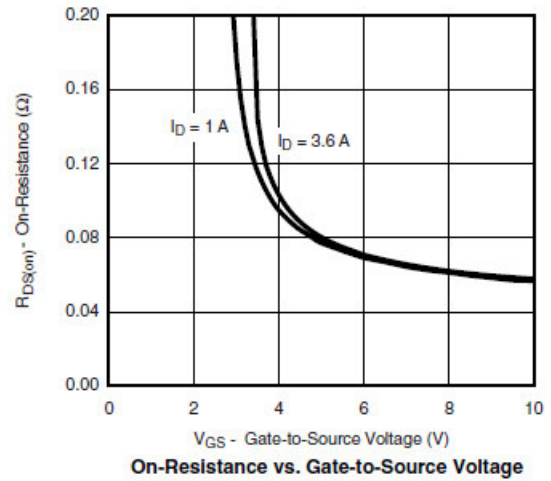
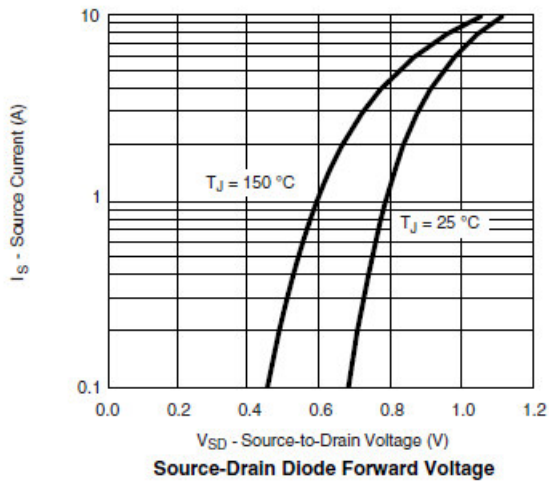

Typical Performance Characteristics (continue)

Gate Charge Test Circuit & Waveform

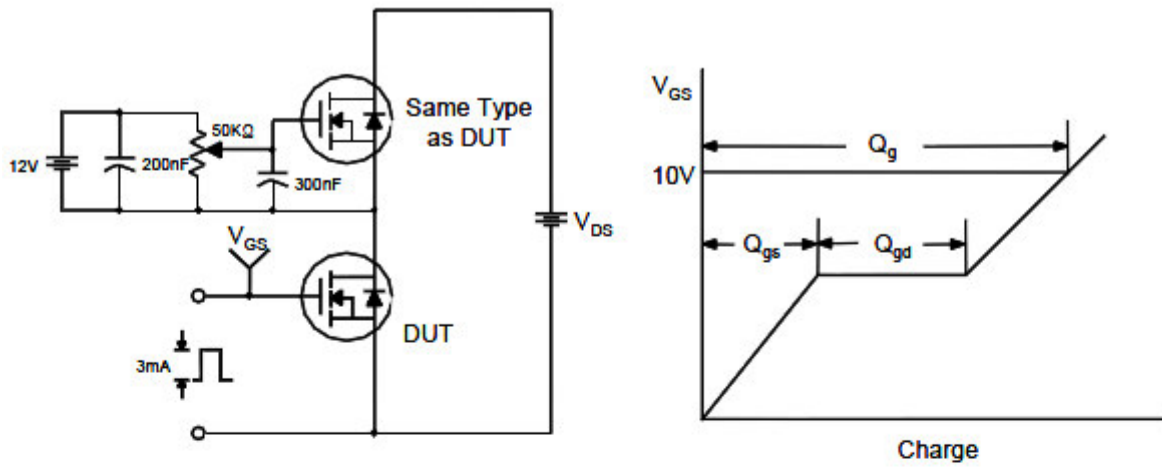

Resistive Switching Test Circuit & Waveforms

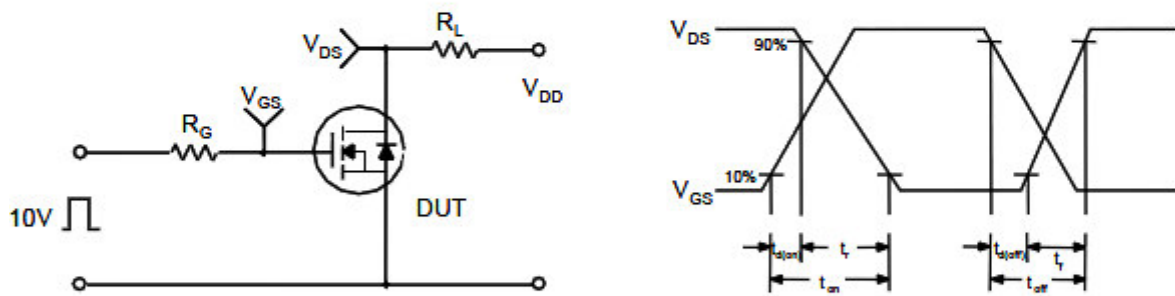

Unclamped Inductive Switching Test Circuit & Waveforms

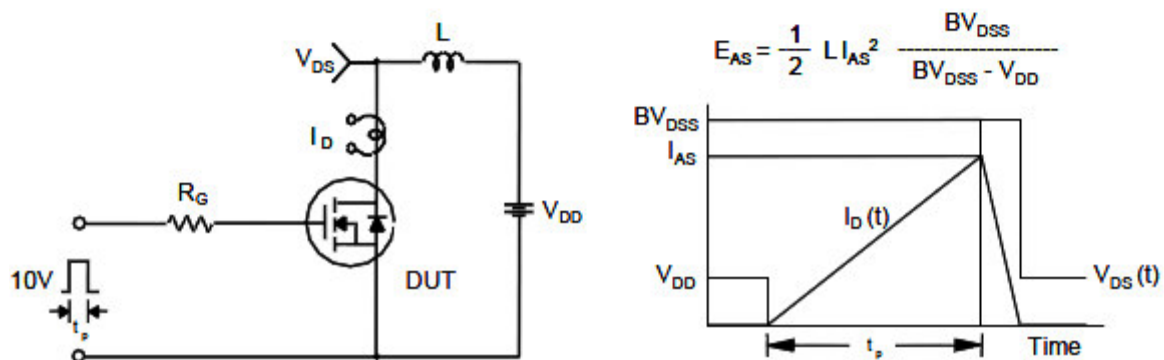

Package Dimension

TSOP-6

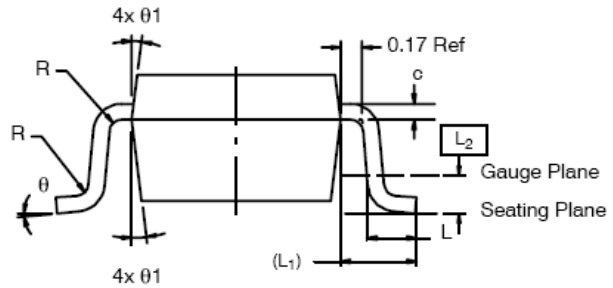
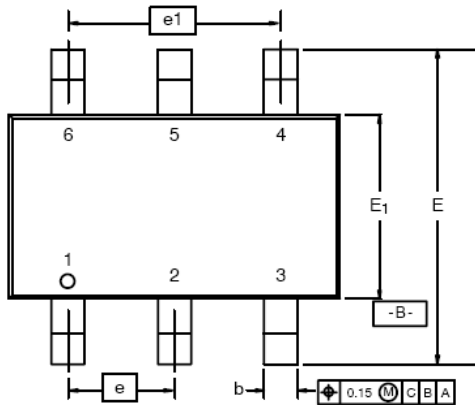





Symbol	Dimensions In Millimeters			Dimensions In Inches		
	Min	Nom	Max	Min	Nom	Max
A	0.91	-	1.10	0.036	-	0.043
A1	0.01	-	0.10	0.0004	-	0.004
A2	0.90	-	1.00	0.035	0.038	0.039
b	0.30	0.32	0.45	0.012	0.013	0.018
c	0.10	0.15	0.20	0.004	0.006	0.008
D	2.95	3.05	3.10	0.116	0.120	0.122
E	2.70	2.85	2.98	0.106	0.112	0.117
E1	1.55	1.65	1.70	0.061	0.065	0.067
e	1.00 BSC			0.0394 BSC		
e1	1.90	2.00	2.10	0.075	0.080	0.085
L	0.35	-	0.50	0.014	-	0.020
L1	0.60 Ref			0.024 Ref		
L2	0.25 BSC			0.010 BSC		
R	0.10	-	-	0.004	-	-
θ	0°	4°	8°	0°	4°	8°
θ1	7° Nom			7° Nom		



NOTICE

Information furnished is believed to be accurate and reliable. However Globaltech Semiconductor assumes no responsibility for the consequences of use of such information nor for any infringement of patents or other rights of third parties, which may result from its use. No license is granted by implication or otherwise under any patent or patent rights of Globaltech Semiconductor. Specifications mentioned in this publication are subject to change without notice. This publication supersedes and replaces all information without express written approval of Globaltech Semiconductor.

CONTACT US

GS Headquarter	
	4F.,No.43-1,Lane11,Sec.6,Minquan E.Rd NeiHu District Taipei City 114, Taiwan (R.O.C)
	886-2-2657-9980
	886-2-2657-3630
	sales_twn@gs-power.com

Wu-Xi Branch	
	No.21 Changjiang Rd., WND, Wuxi, Jiangsu, China (INFO. & TECH. Science Park Building A 210 Room)
	86-510-85217051
	86-510-85211238
	sales_cn@gs-power.com

RD Division	
	824 Bolton Drive Milpitas. CA. 95035
	1-408-457-0587