

GSM1024E

20V N-Channel Enhancement Mode MOSFET

Product Description

GSM1024E, N-Channel enhancement mode MOSFET, uses Advanced Trench Technology to provide excellent $R_{DS(ON)}$, low gate charge.

These devices are particularly suited for low voltage power management, such as smart phone and notebook computer, and low in-line power loss are needed in commercial industrial surface mount applications.

Features

- 20V/0.6A, $R_{DS(ON)}=360m\Omega@V_{GS}=4.5V$
- 20V/0.5A, $R_{DS(ON)}=420m\Omega@V_{GS}=2.5V$
- 20V/0.4A, $R_{DS(ON)}=560m\Omega@V_{GS}=1.8V$
- Low Offset (Error) Voltage
- Low-Voltage Operation
- High-Speed Circuits
- Low Battery Voltage Operation
- ESD Protected (2KV) Diode design-in
- SOT-563 package design

Applications

- Drivers: Relays, Solenoids, Lamps, Hammers, Displays, Memories
- Battery Operated Systems
- Power Supply Converter Circuits
- Load/Power Switching Smart Phones, Pagers

Packages & Pin Assignments

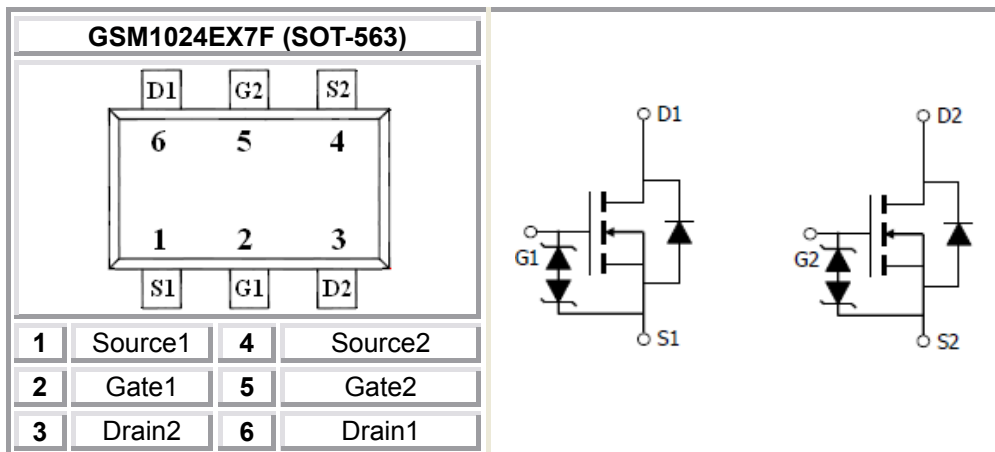

Ordering Information

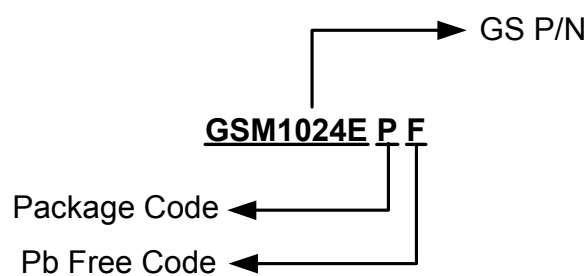

Marking Information

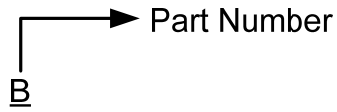

Part Number	Package	Part Marking
GSM1024EX7F	SOT-563	<u>B</u>

Absolute Maximum Ratings

(T_A=25°C unless otherwise noted)

Symbol	Parameter	Typical	Unit	
V _{DSS}	Drain-Source Voltage	20	V	
V _{GSS}	Gate –Source Voltage	±12	V	
I _D	Continuous Drain Current(T _J =150°C)	T _A =25°C	0.7	A
		T _A =70°C	0.4	
I _{DM}	Pulsed Drain Current	1.0	A	
I _S	Continuous Source Current(Diode Conduction)	0.3	A	
P _D	Power Dissipation	T _A =25°C	0.27	W
		T _A =70°C	0.16	
T _J	Operating Junction Temperature	-55/150	°C	
T _{STG}	Storage Temperature Range	-55/150	°C	

Electrical Characteristics

($T_A=25^\circ\text{C}$ unless otherwise noted)

Symbol	Parameter	Conditions	Min.	Typ	Max.	Unit
Static						
$V_{(BR)DSS}$	Drain-Source Breakdown Voltage	$V_{GS}=0V, I_D=250\mu\text{A}$	20			V
$V_{GS(th)}$	Gate Threshold Voltage	$V_{DS}=V_{GS}, I_D=250\mu\text{A}$	0.3		0.8	
I_{GSS}	Gate Leakage Current	$V_{DS}=0V, V_{GS}=\pm 12V$			± 1	nA
I_{DSS}	Zero Gate Voltage Drain Current	$V_{DS}=16V, V_{GS}=0V$			1	uA
		$V_{DS}=16V, V_{GS}=0V, T_J=85^\circ\text{C}$			5	
$I_{D(on)}$	On-State Drain Current	$V_{DS}\geq 5V, V_{GS}=4.5V$	0.7			A
$R_{DS(on)}$	Drain-Source On-Resistance	$V_{GS}=4.5V, I_D=0.6A$		240	360	m Ω
		$V_{GS}=2.5V, I_D=0.5A$		300	420	
		$V_{GS}=1.8V, I_D=0.4A$		420	560	
g_{fs}	Forward Transconductance	$V_{DS}=10V, I_D=0.4A$		1		S
V_{SD}	Diode Forward Voltage	$I_S=0.15A, V_{GS}=0V$		0.8	1.2	V
Dynamic						
C_{iss}	Input Capacitance	$V_{DS}=10V, V_{GS}=0V$ $f=1\text{MHz}$		70		pF
C_{oss}	Output Capacitance			20		
C_{rSS}	Reverse Transfer Capacitance			8		
Q_g	Total Gate Charge	$V_{DS}=10V, V_{GS}=4.5V, I_D=0.6A$		1.06	1.38	nC
Q_{gs}	Gate-Source Charge			0.18		
Q_{gd}	Gate-Drain Charge			0.32		
$t_{d(on)}$	Turn-On Time	$V_{DD}=10V, R_L=20\Omega, I_D=0.5A, V_{GEN}=4.5V, R_G=1\Omega$		18	26	ns
t_r				20	28	
$t_{d(off)}$	Turn-Off Time			70	110	
t_f				25	40	

Typical Performance Characteristics

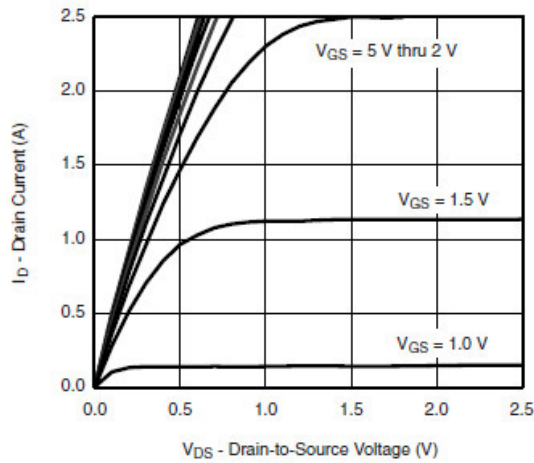

Output Characteristics

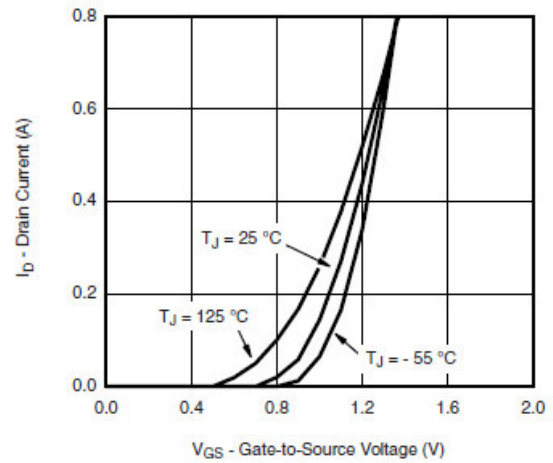

Transfer Characteristics

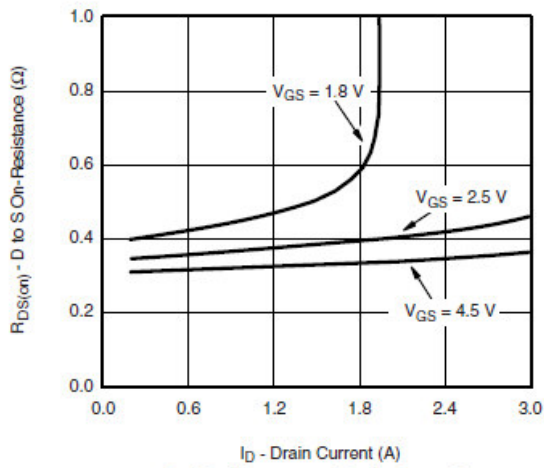

On-Resistance vs. Drain Current

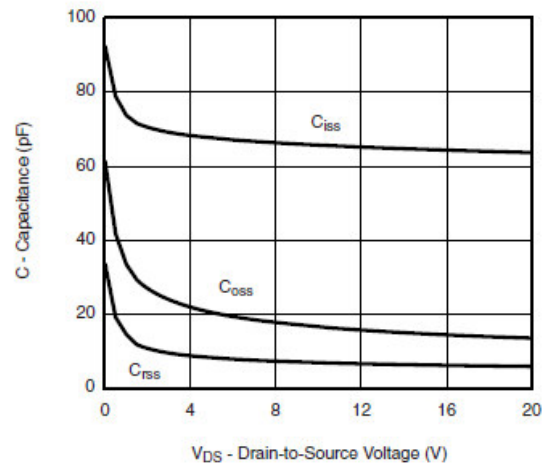

Capacitance

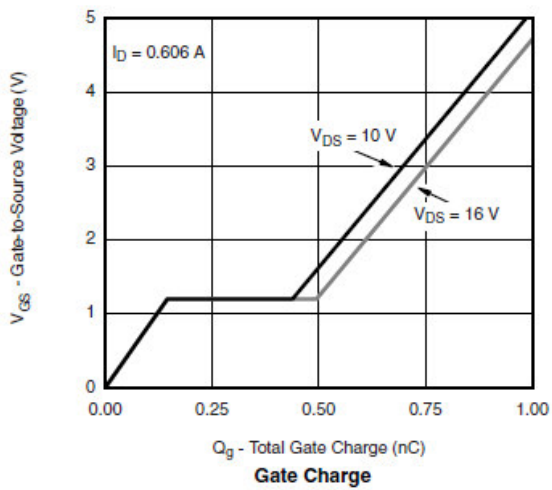

Gate Charge

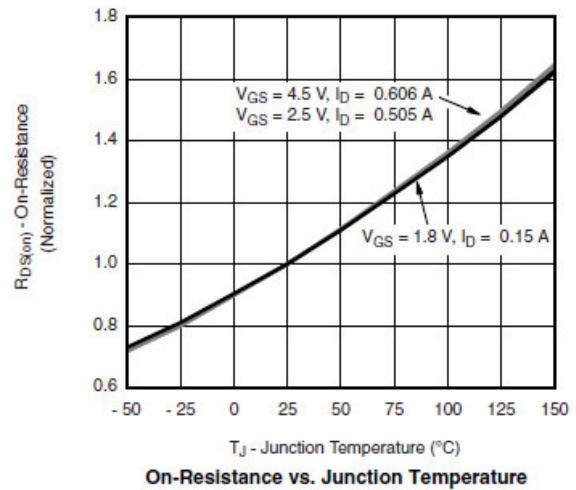

On-Resistance vs. Junction Temperature

Typical Performance Characteristics (continue)

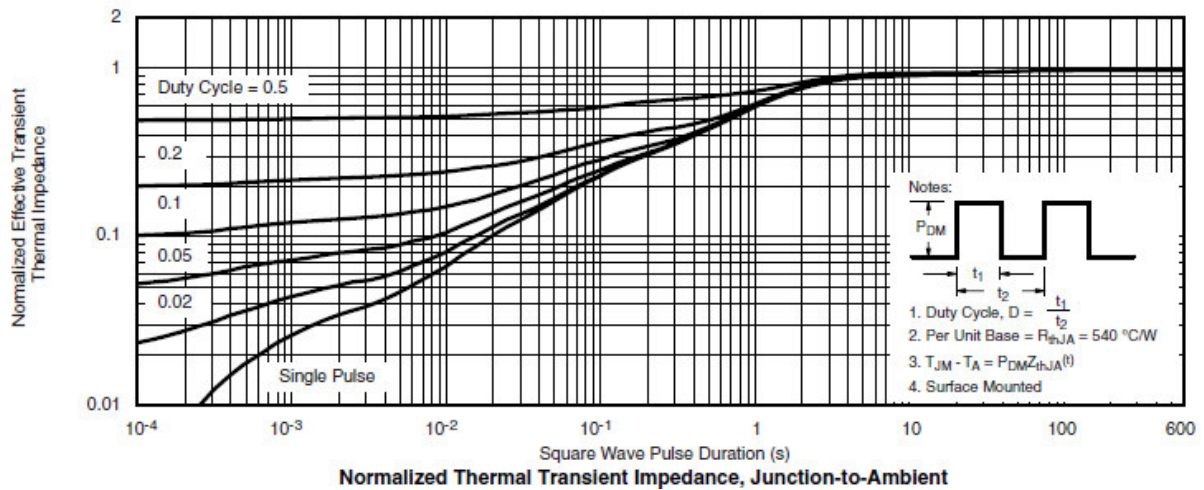
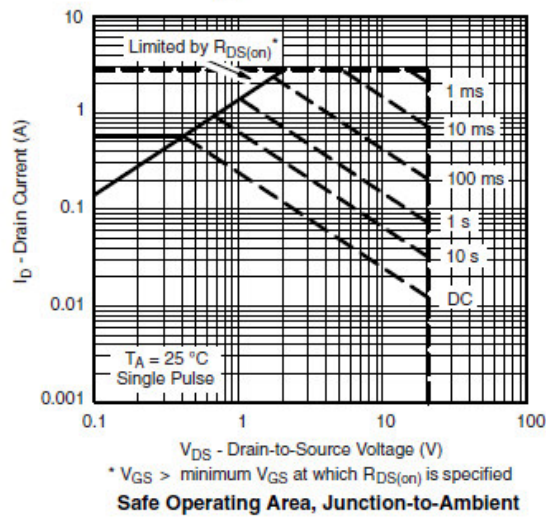
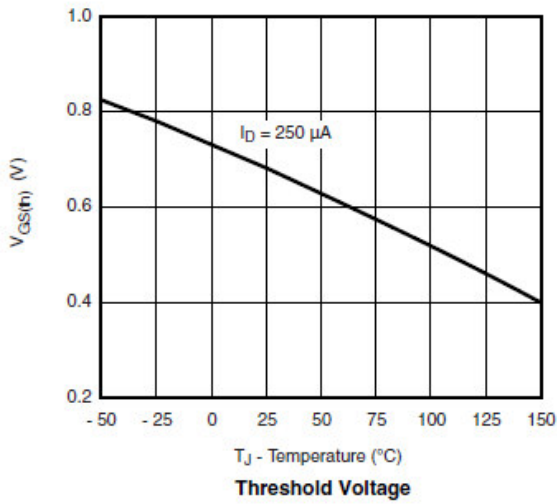
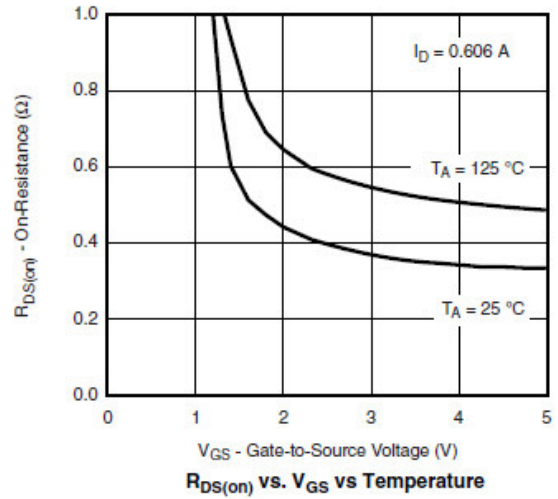
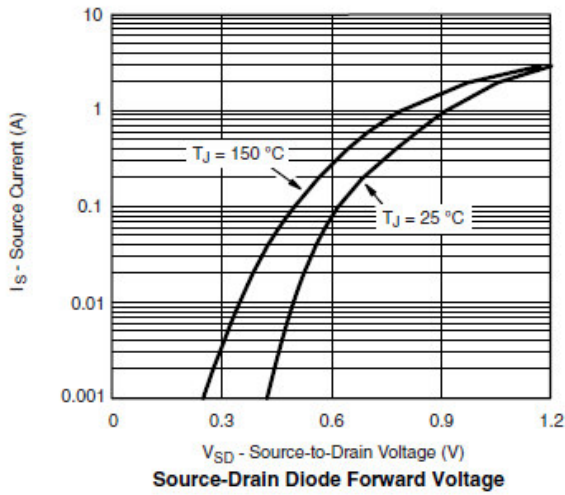

Typical Characteristics

Gate Charge Test Circuit & Waveform

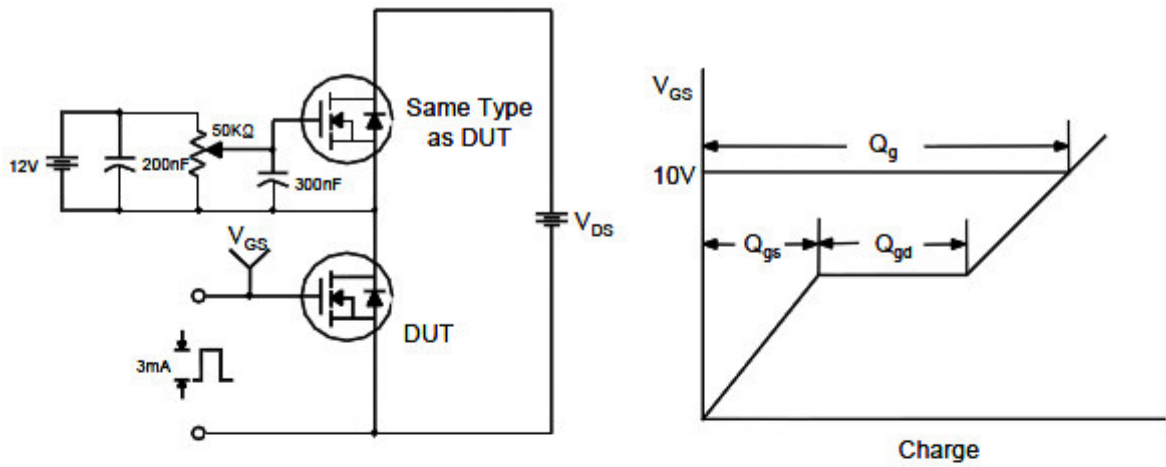

Resistive Switching Test Circuit & Waveforms

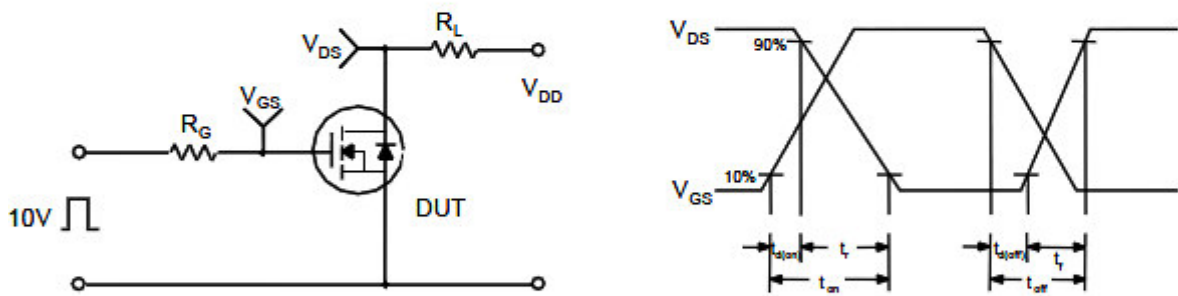

Unclamped Inductive Switching Test Circuit & Waveforms

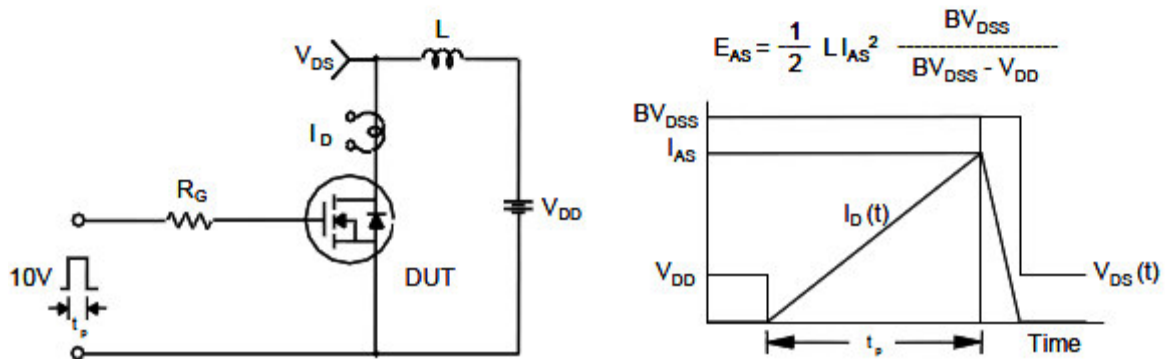

Package Dimension

SOT-563

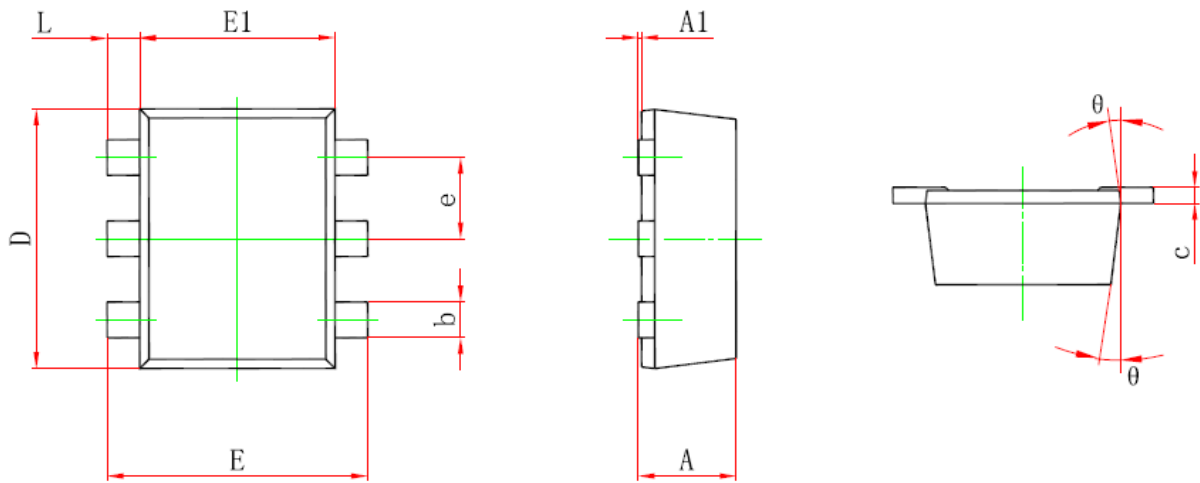









Dimensions				
Symbol	Millimeters		Inches	
	Min	Max	Min	Max
A	0.525	0.600	0.021	0.024
A1	0.000	0.050	0.000	0.002
e	0.450	0.550	0.018	0.022
c	0.090	0.160	0.004	0.006
D	1.500	1.700	0.059	0.067
b	0.170	0.270	0.007	0.011
E1	1.100	1.300	0.043	0.051
E	1.500	1.700	0.059	0.067
L	0.100	0.300	0.004	0.012
θ	7° REF		7° REF	



NOTICE

Information furnished is believed to be accurate and reliable. However Globaltech Semiconductor assumes no responsibility for the consequences of use of such information nor for any infringement of patents or other rights of third parties, which may result from its use. No license is granted by implication or otherwise under any patent or patent rights of Globaltech Semiconductor. Specifications mentioned in this publication are subject to change without notice. This publication supersedes and replaces all information without express written approval of Globaltech Semiconductor.

CONTACT US

GS Headquarter	
	4F.,No.43-1,Lane11,Sec.6,Minquan E.Rd Neihu District Taipei City 114, Taiwan (R.O.C)
	886-2-2657-9980
	886-2-2657-3630
	sales_twn@gs-power.com

Wu-Xi Branch	
	No.21 Changjiang Rd., WND, Wuxi, Jiangsu, China (INFO. &. TECH. Science Park Building A 210 Room)
	86-510-85217051
	86-510-85211238
	sales_cn@gs-power.com

RD Division	
	824 Bolton Drive Milpitas. CA. 95035
	1-408-457-0587