

# GSM1024

## 20V N-Channel Enhancement Mode MOSFET

### Product Description

GSM1024, N-Channel enhancement mode MOSFET, uses Advanced Trench Technology to provide excellent  $R_{DS(ON)}$ , low gate charge. These devices are particularly suited for low voltage power management, such as smart phone and notebook computer, and low in-line power loss are needed in commercial industrial surface mount applications.

### Features

- 20V/0.6A,  $R_{DS(ON)}=360m\Omega@V_{GS}=4.5V$
- 20V/0.5A,  $R_{DS(ON)}=420m\Omega@V_{GS}=2.5V$
- 20V/0.4A,  $R_{DS(ON)}=560m\Omega@V_{GS}=1.8V$
- Low Offset (Error) Voltage
- Low-Voltage Operation
- High-Speed Circuits
- Low Battery Voltage Operation
- SOT-563 package design

### Applications

- Drivers: Relays, Solenoids, Lamps, Hammers, Displays, Memories
- Battery Operated Systems
- Power Supply Converter Circuits
- Load/Power Switching Smart Phones, Pagers

### Packages & Pin Assignments

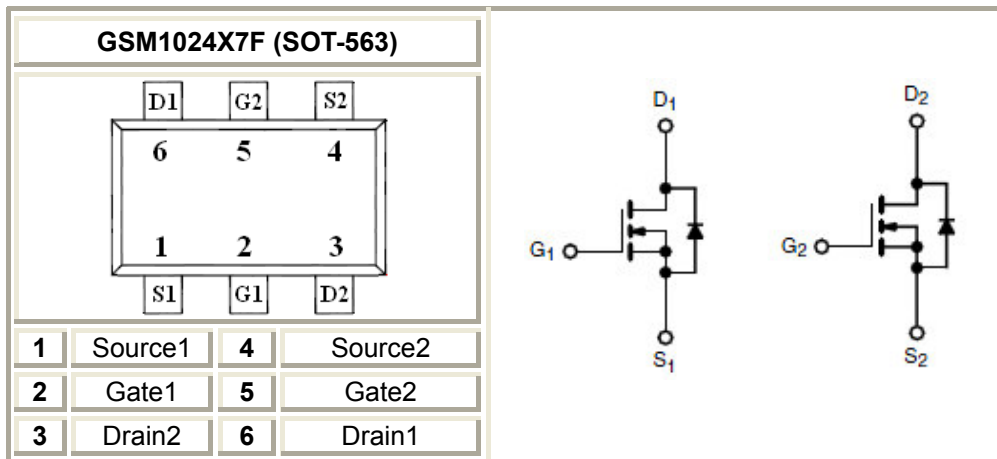

### Ordering Information

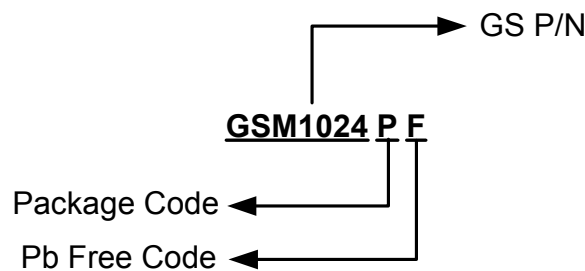

## Marking Information

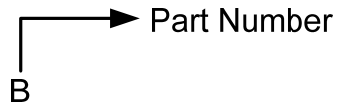

Part Number	Package	Part Marking
GSM1024X7F	SOT-563	B

## Absolute Maximum Ratings

( $T_A=25^\circ\text{C}$  unless otherwise noted)

Symbol	Parameter	Typical	Unit	
$V_{DSS}$	Drain-Source Voltage	20	V	
$V_{GSS}$	Gate –Source Voltage	$\pm 12$	V	
$I_D$	Continuous Drain Current( $T_J=150^\circ\text{C}$ )	$T_A=25^\circ\text{C}$	0.7	A
		$T_A=70^\circ\text{C}$	0.4	
$I_{DM}$	Pulsed Drain Current	1.0	A	
$I_S$	Continuous Source Current(Diode Conduction)	0.3	A	
$P_D$	Power Dissipation	$T_A=25^\circ\text{C}$	0.27	W
		$T_A=70^\circ\text{C}$	0.16	
$T_J$	Operating Junction Temperature	-55/150	$^\circ\text{C}$	
$T_{STG}$	Storage Temperature Range	-55/150	$^\circ\text{C}$	

## Electrical Characteristics

( $T_A=25^\circ\text{C}$  unless otherwise noted)

Symbol	Parameter	Conditions	Min.	Typ	Max.	Unit
<b>Static</b>						
$V_{(BR)DSS}$	Drain-Source Breakdown Voltage	$V_{GS}=0V, I_D=250\mu A$	20			V
$V_{GS(th)}$	Gate Threshold Voltage	$V_{DS}=V_{GS}, I_D=250\mu A$	0.4		1.0	
$I_{GSS}$	Gate Leakage Current	$V_{DS}=0V, V_{GS}=\pm 12V$			$\pm 100$	nA
$I_{DSS}$	Zero Gate Voltage Drain Current	$V_{DS}=20V, V_{GS}=0V$			1	uA
		$V_{DS}=20V, V_{GS}=0V, T_J=85^\circ\text{C}$			5	
$I_{D(on)}$	On-State Drain Current	$V_{DS}\geq 5V, V_{GS}=4.5V$	0.7			A
$R_{DS(on)}$	Drain-Source On-Resistance	$V_{GS}=4.5V, I_D=0.6A$		240	360	m $\Omega$
		$V_{GS}=2.5V, I_D=0.5A$		300	420	
		$V_{GS}=1.8V, I_D=0.4A$		420	560	
$g_{fs}$	Forward Transconductance	$V_{DS}=10V, I_D=0.4A$		1		S
$V_{SD}$	Diode Forward Voltage	$I_S=0.15A, V_{GS}=0V$		0.8	1.2	V
<b>Dynamic</b>						
$C_{iss}$	Input Capacitance	$V_{DS}=10V, V_{GS}=0V$ $f=1\text{MHz}$		70		pF
$C_{oss}$	Output Capacitance			20		
$C_{riss}$	Reverse Transfer Capacitance			8		
$Q_g$	Total Gate Charge	$V_{DS}=10V, V_{GS}=4.5V, I_D=0.6A$		1.06	1.38	nC
$Q_{gs}$	Gate-Source Charge			0.18		
$Q_{gd}$	Gate-Drain Charge			0.32		
$t_{d(on)}$	Turn-On Time	$V_{DD}=10V, R_L=20\Omega, I_D=0.5A, V_{GEN}=4.5V, R_G=1\Omega$		18	26	ns
$t_r$				20	28	
$t_{d(off)}$	Turn-Off Time			70	110	
$t_f$				25	40	

## Typical Performance Characteristics

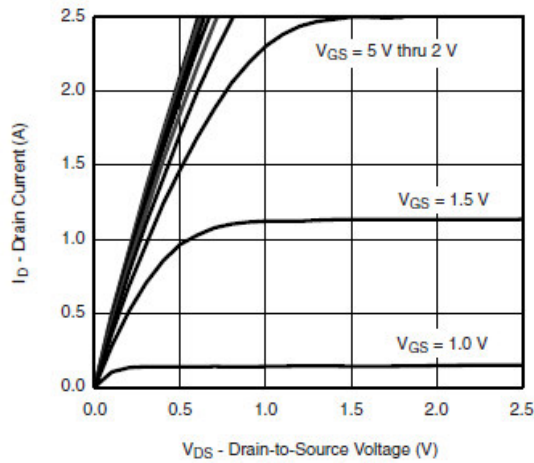

Output Characteristics

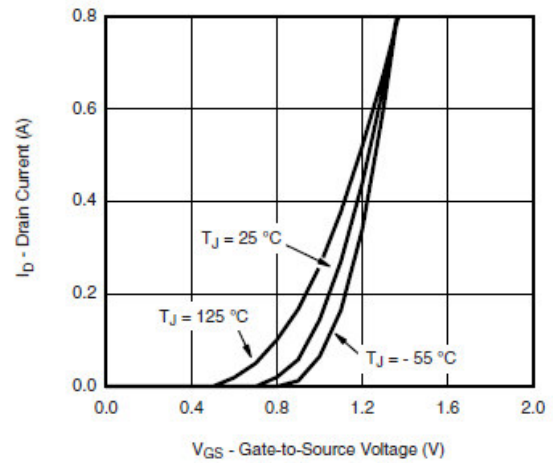

Transfer Characteristics

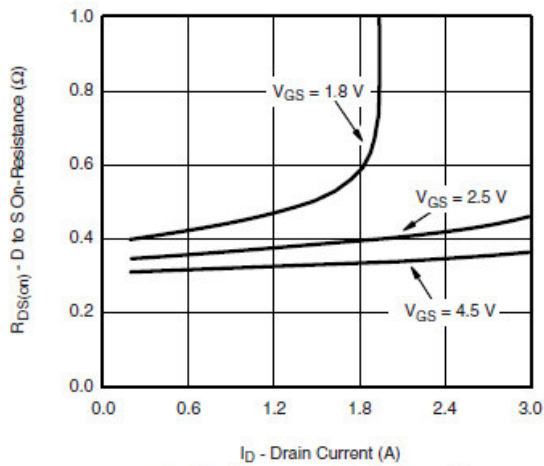

On-Resistance vs. Drain Current

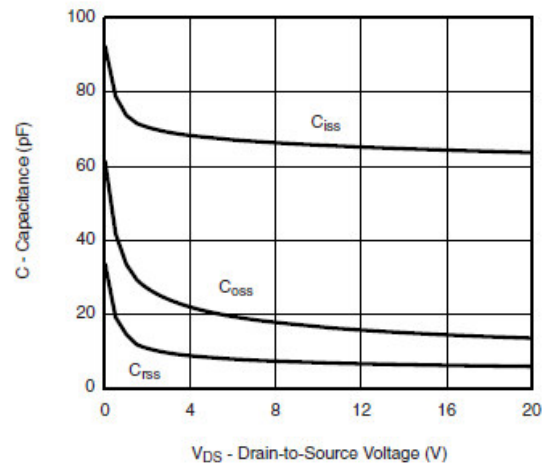

Capacitance

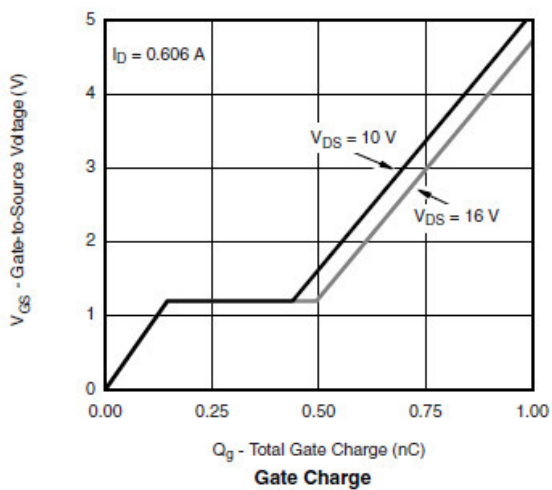

Gate Charge

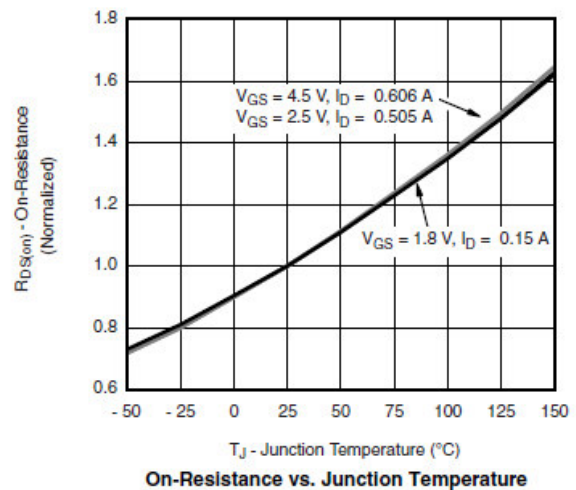

On-Resistance vs. Junction Temperature

## Typical Performance Characteristics (continue)

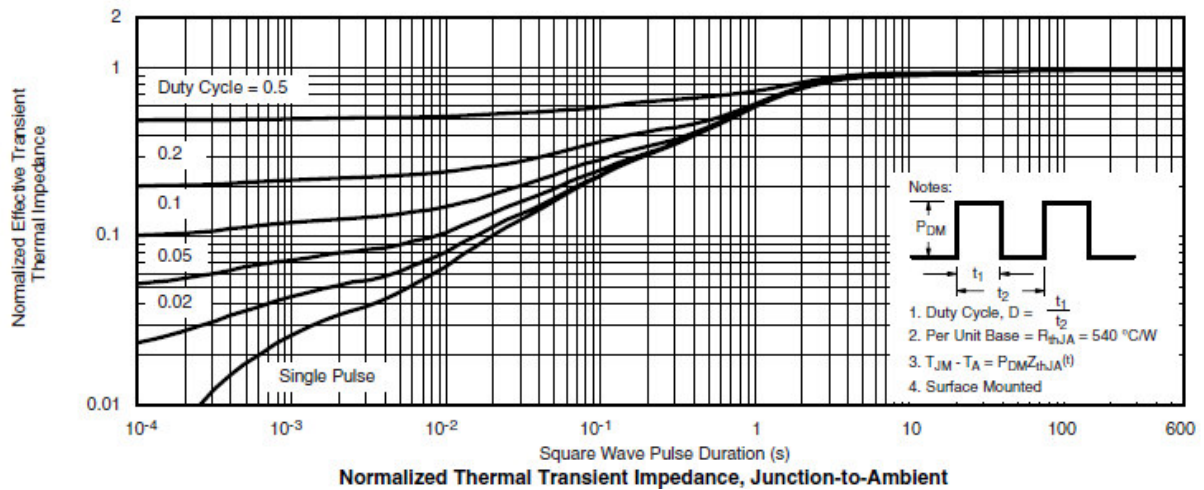
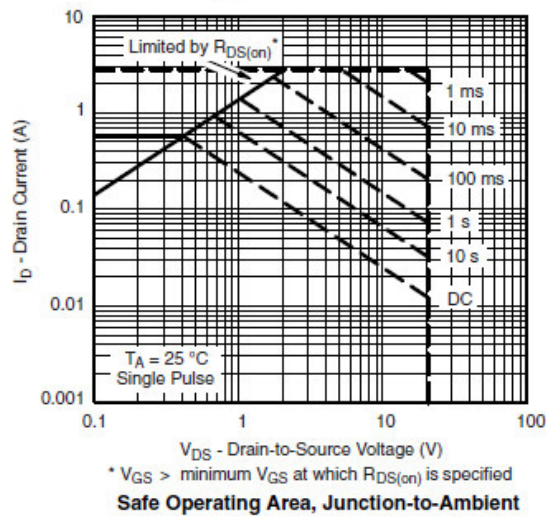
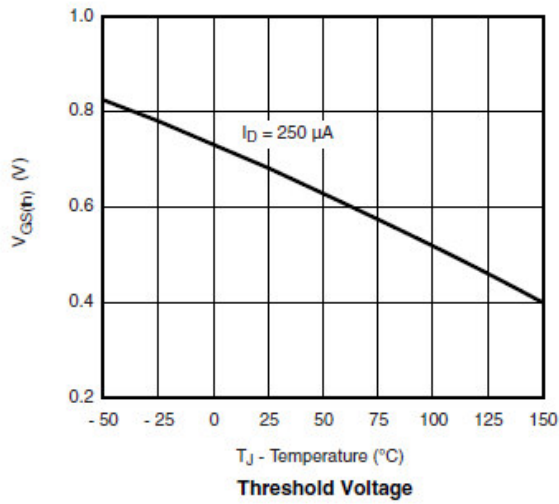
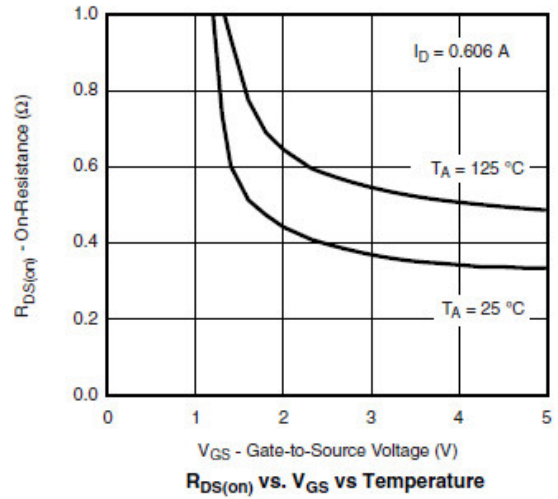
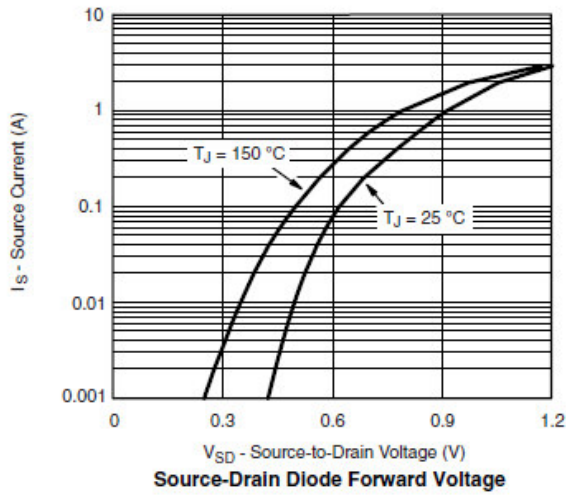

## Typical Characteristics

Gate Charge Test Circuit & Waveform

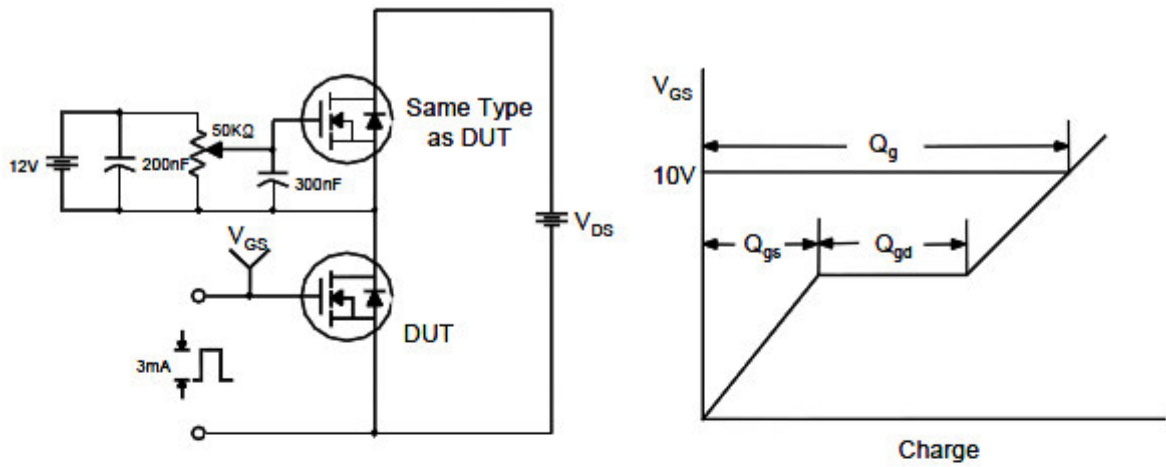

Resistive Switching Test Circuit & Waveforms

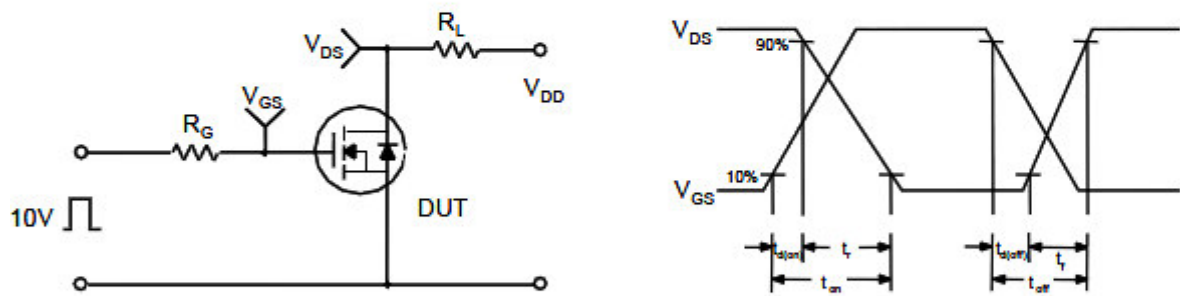

Unclamped Inductive Switching Test Circuit & Waveforms

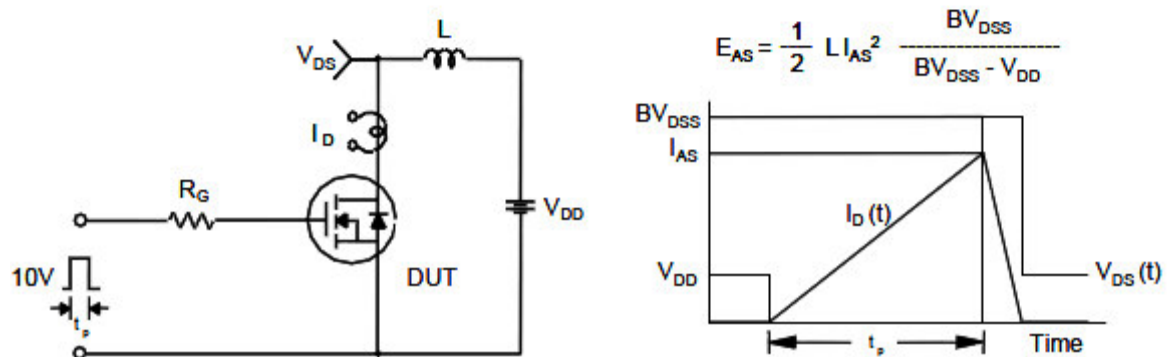

## Package Dimension

### SOT-563

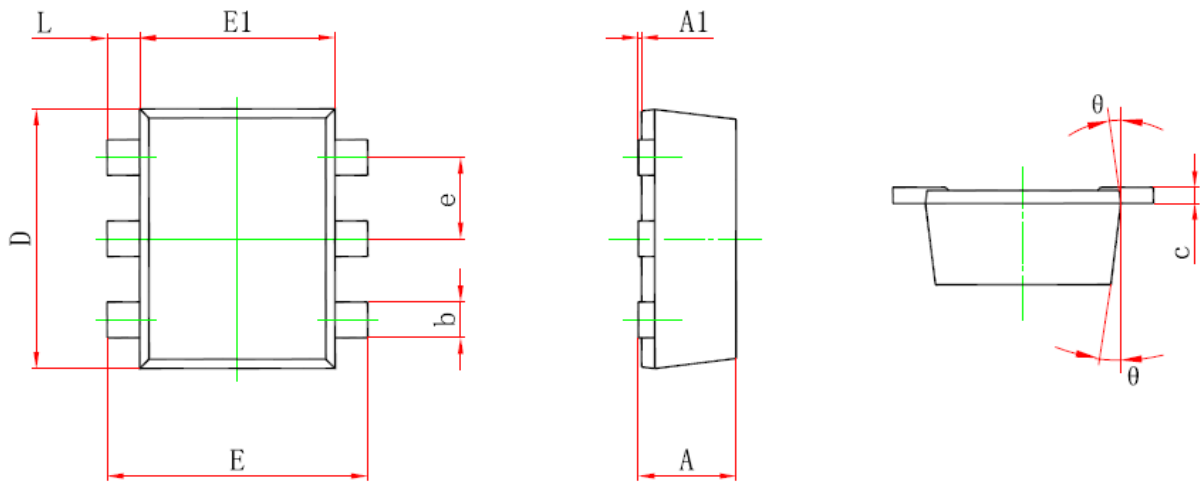





Dimensions				
Symbol	Millimeters		Inches	
	Min	Max	Min	Max
A	0.525	0.600	0.021	0.024
A1	0.000	0.050	0.000	0.002
e	0.450	0.550	0.018	0.022
c	0.090	0.160	0.004	0.006
D	1.500	1.700	0.059	0.067
b	0.170	0.270	0.007	0.011
E1	1.100	1.300	0.043	0.051
E	1.500	1.700	0.059	0.067
L	0.100	0.300	0.004	0.012
θ	7° REF		7° REF	





## NOTICE

Information furnished is believed to be accurate and reliable. However Globaltech Semiconductor assumes no responsibility for the consequences of use of such information nor for any infringement of patents or other rights of third parties, which may result from its use. No license is granted by implication or otherwise under any patent or patent rights of Globaltech Semiconductor. Specifications mentioned in this publication are subject to change without notice. This publication supersedes and replaces all information without express written approval of Globaltech Semiconductor.



## CONTACT US

GS Headquarter	
	4F.,No.43-1,Lane11,Sec.6,Minquan E.Rd Neihu District Taipei City 114, Taiwan (R.O.C)
	886-2-2657-9980
	886-2-2657-3630
	sales_twn@gs-power.com

Wu-Xi Branch	
	No.21 Changjiang Rd., WND, Wuxi, Jiangsu, China (INFO. &. TECH. Science Park Building A 210 Room)
	86-510-85217051
	86-510-85211238
	sales_cn@gs-power.com

RD Division	
	824 Bolton Drive Milpitas. CA. 95035
	1-408-457-0587