

GSM7412

20V N-Channel Enhancement Mode MOSFET

Product Description

GSM7412, N-Channel enhancement mode MOSFET, uses Advanced Trench Technology to provide excellent $R_{DS(ON)}$, low gate charge.

These devices are particularly suited for low voltage power management, such as smart phone and notebook computer and other battery powered circuits, and low in-line power loss are needed in commercial industrial surface mount applications.

Features

- 20V/3.8A , $R_{DS(ON)}= 52m\Omega@V_{GS}=4.5V$
- 20V/3.2A , $R_{DS(ON)}= 56m\Omega@V_{GS}=2.5V$
- 20V/2.8A , $R_{DS(ON)}= 68m\Omega@V_{GS}=1.8V$
- Super high density cell design for extremely low $R_{DS(ON)}$
- Exceptional on-resistance and maximum DC current capability
- SOT-323(SC-70) package design

Applications

- Portable Equipment
- Battery Powered System
- Net Working System

Packages & Pin Assignments

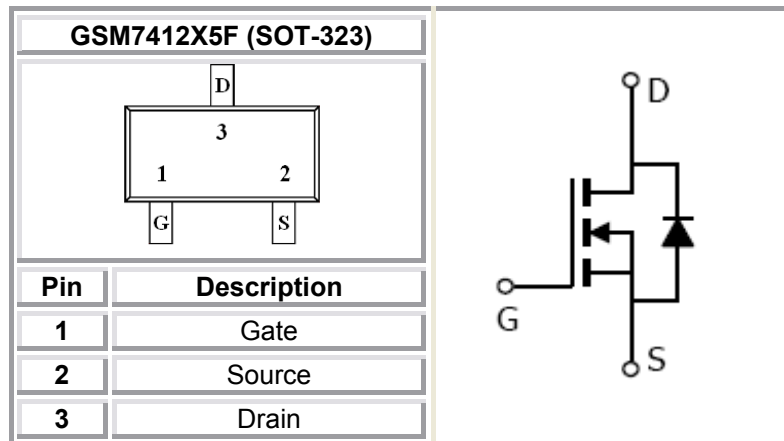

Ordering Information

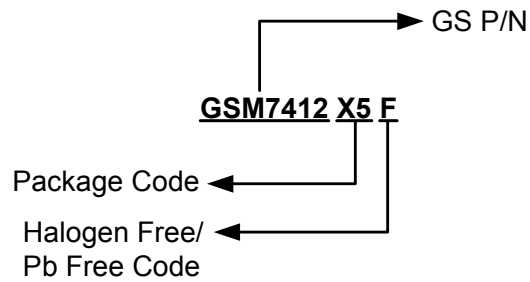

Part Number	Package	Quantity
GSM7412X5F	SOT-323	3000 PCS

Marking Information

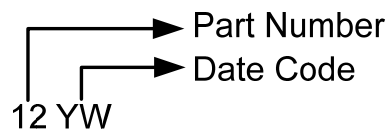

Absolute Maximum Ratings

T_A=25°C Unless otherwise noted

Symbol	Parameter	Typical	Unit
V _{DSS}	Drain-Source Voltage	20	V
V _{GSS}	Gate-Source Voltage	±12	V
I _D	Continuous Drain Current(T _J =150°C)	T _A =25°C	3.8
		T _A =70°C	2.6
I _{DM}	Pulsed Drain Current	10	A
I _S	Continuous Source Current(Diode Conduction)	1.6	A
P _D	Power Dissipation	T _A =25°C	0.35
		T _A =70°C	0.22
T _J	Operating Junction Temperature	150	°C
T _{STG}	Storage Temperature Range	-55/150	°C
R _{θJA}	Thermal Resistance-Junction to Ambient	120	°C/ W

Electrical Characteristics

T_A=25°C unless otherwise noted

Symbol	Parameter	Conditions	Min	Typ	Max	Unit
Static						
V _{(BR)DSS}	Drain-Source Breakdown Voltage	V _{GS} =0V, I _D =250μA	20			V
V _{GS(th)}	Gate Threshold Voltage	V _{DS} =V _{GS} , I _D =250μA	0.4		0.8	V
I _{GSS}	Gate Leakage Current	V _{DS} =0V, V _{GS} =±12V			±100	nA
I _{DSS}	Zero Gate Voltage Drain Current	V _{DS} = 16V, V _{GS} =0V			1	μA
		V _{DS} = 16V, V _{GS} =0V, T _J =85°C			10	
I _{D(on)}	On-State Drain Current	V _{DS} ≥ 5V, V _{GS} =4.5V	6			A
		V _{DS} ≥ 5V, V _{GS} =2.5V	4			
R _{DS(on)}	Drain-Source On-Resistance	V _{GS} =4.5V, I _D =3.8A		48	52	mΩ
		V _{GS} =2.5V, I _D =3.2A		52	56	
		V _{GS} =1.8V, I _D =2.6A		62	68	
g _{fs}	Forward Transconductance	V _{DS} =5V, I _D =3.6A		10		S
V _{SD}	Diode Forward Voltage	I _S =1.6A, V _{GS} =0V		0.85	1.2	V
Dynamic						
C _{iss}	Input Capacitance	V _{DS} =10V, V _{GS} =0V, f=1MHz		850		pF
C _{oss}	Output Capacitance			120		
C _{rss}	Reverse Transfer Capacitance			60		
Q _g	Total Gate Charge	V _{DS} =10V, V _{GS} =4.5V, I _D =4.0A		8.2	14	nC
Q _{gs}	Gate-Source Charge			1.2		
Q _{gd}	Gate-Drain Charge			1.0		
t _{d(on)}	Turn-On Time	V _{DD} =10V, R _L =2.2Ω, I _D =4.0A, V _{GEN} =4.5V, R _G =1Ω		10	16	ns
t _r				16	25	
t _{d(off)}	Turn-Off Time			31	45	
t _f				10	16	

Typical Performance Characteristics

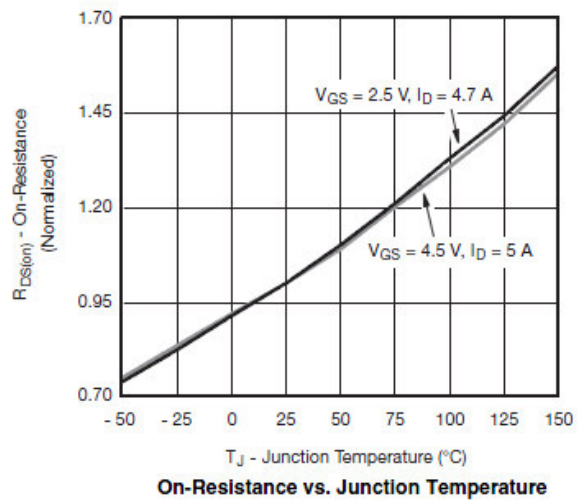
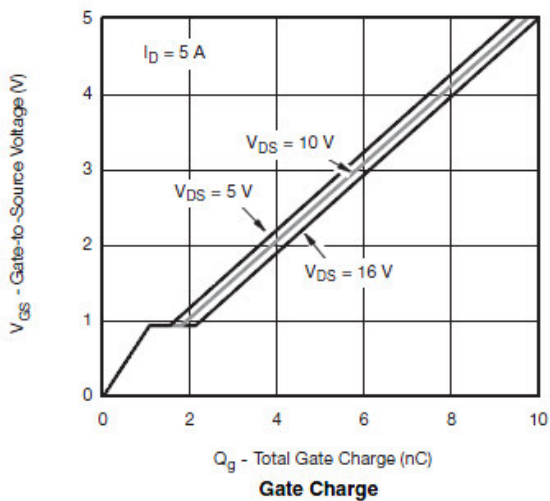
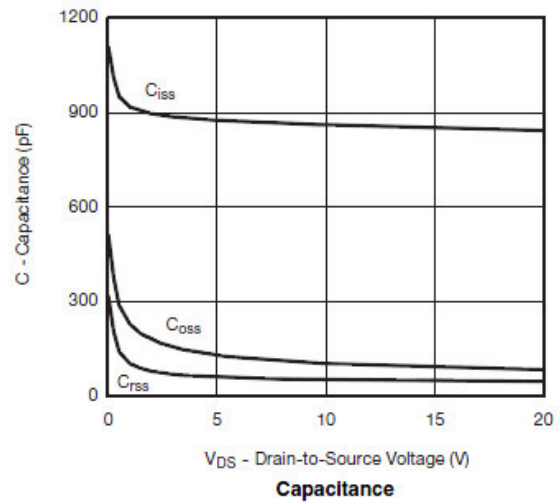
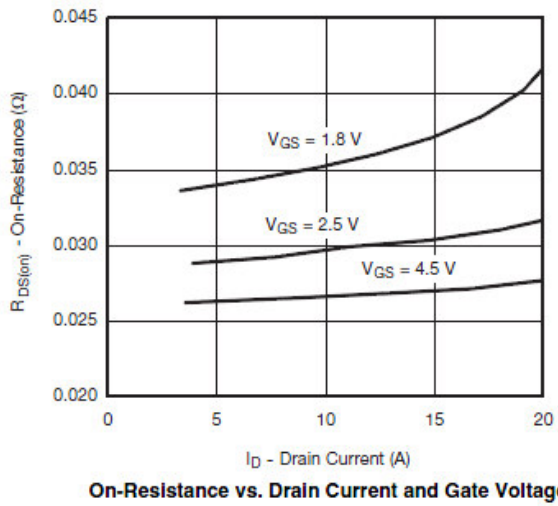
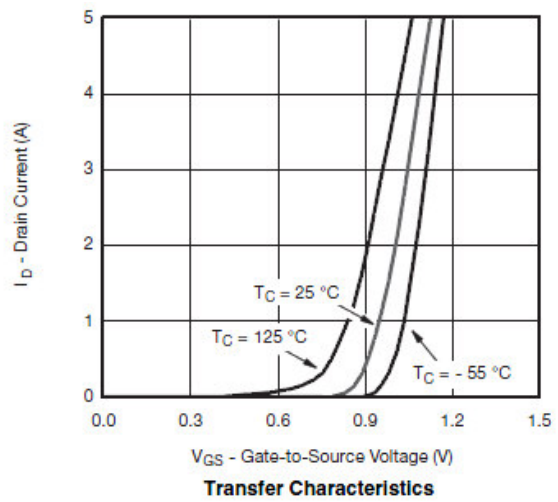
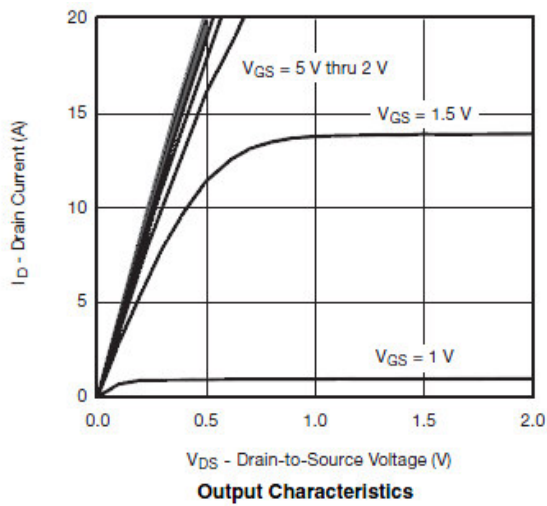

Typical Characteristics

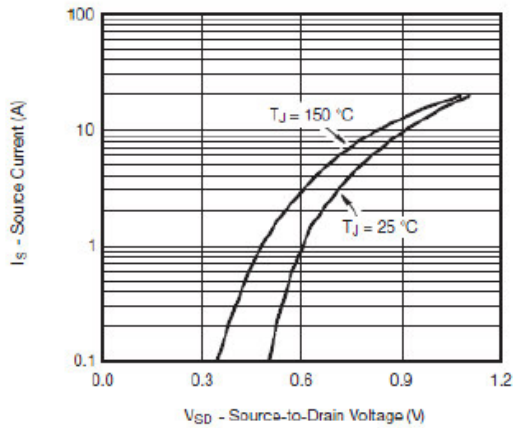

Source-Drain Diode Forward Voltage

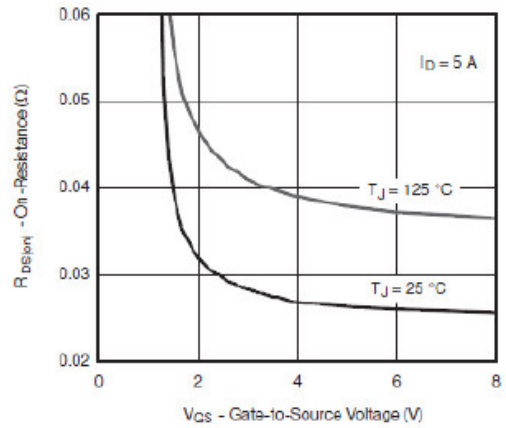

On-Resistance vs. Gate-to-Source Voltage

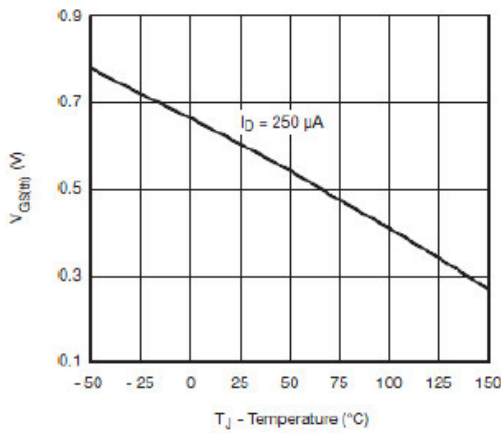

Threshold Voltage

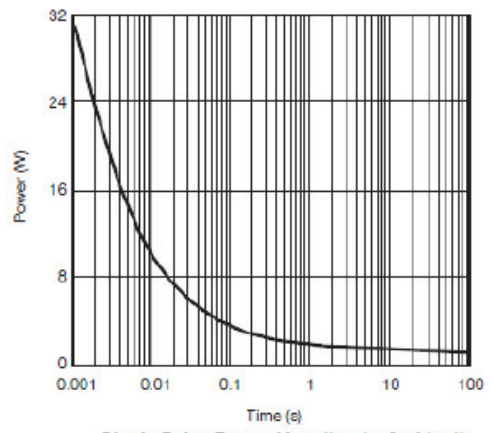

Single Pulse Power (Junction-to-Ambient)

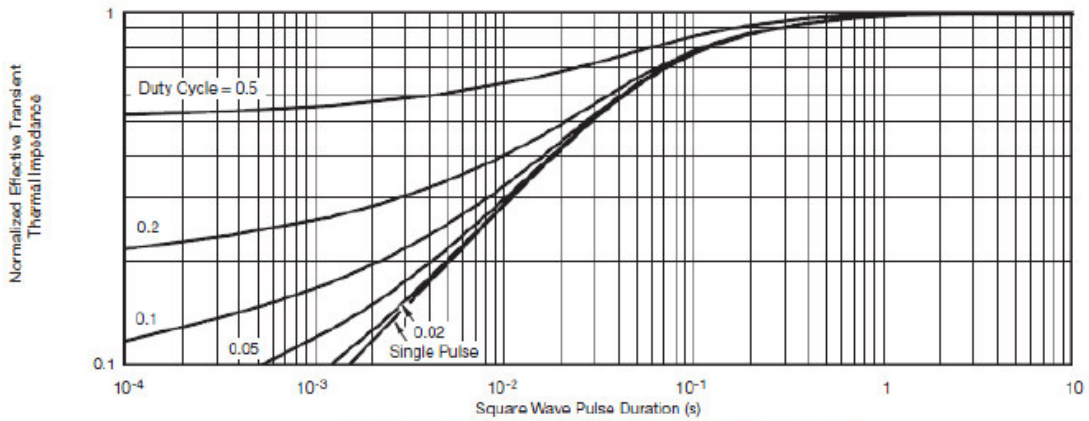

Normalized Thermal Transient Impedance, Junction-to-Foot

Typical Characteristics

Gate Charge Test Circuit & Waveform

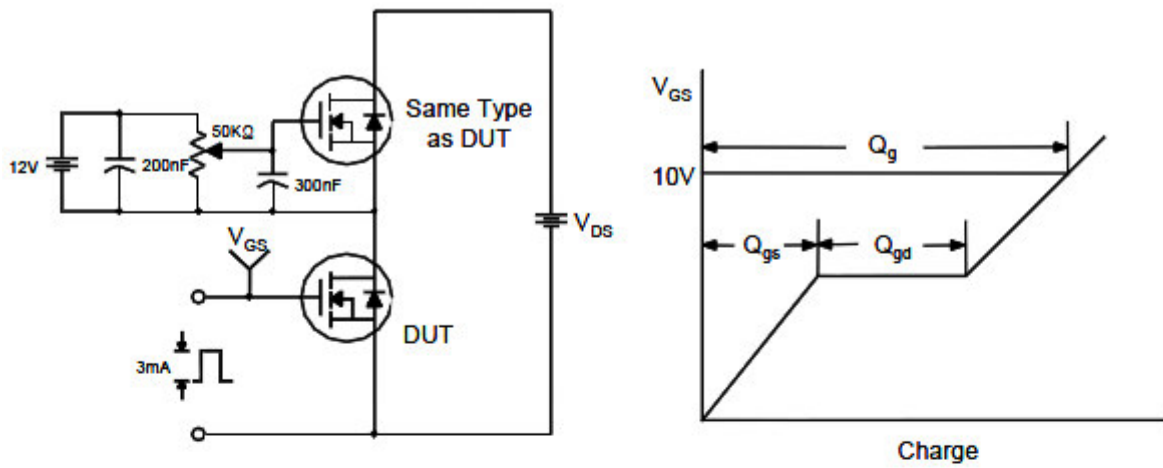

Resistive Switching Test Circuit & Waveforms

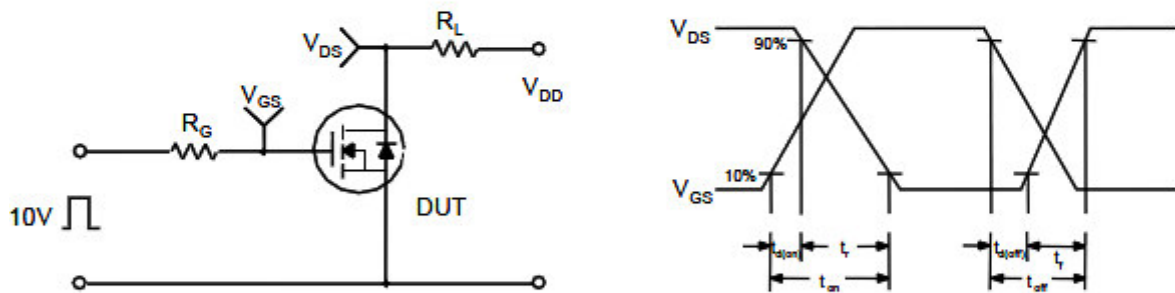

Unclamped Inductive Switching Test Circuit & Waveforms

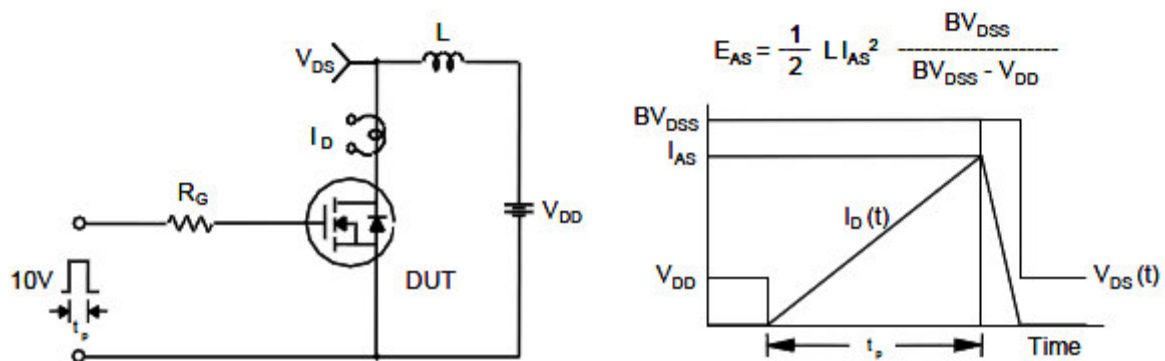

Package Dimension

SOT-323 PLASTIC PACKAGE

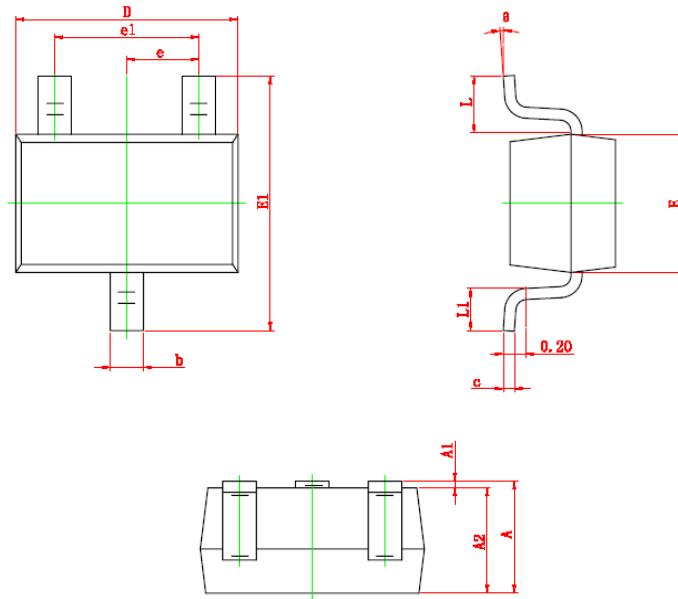





Dimensions				
Symbol	Millimeters		Inches	
	Min	Max	Min	Max
A	0.900	1.100	0.035	0.043
A1	0.000	0.100	0.000	0.004
A2	0.900	1.000	0.035	0.039
b	0.200	0.400	0.008	0.016
c	0.080	0.150	0.003	0.006
D	2.000	2.200	0.079	0.087
E	1.150	1.350	0.045	0.053
E1	2.150	2.450	0.085	0.096
e	0.650 TYP		0.026 TYP	
e1	1.200	1.400	0.047	0.055
L	0.525 REF		0.021 REF	
L1	0.260	0.460	0.010	0.018
θ	0°	8°	0°	8°



NOTICE

Information furnished is believed to be accurate and reliable. However Globaltech Semiconductor assumes no responsibility for the consequences of use of such information nor for any infringement of patents or other rights of third parties, which may result from its use. No license is granted by implication or otherwise under any patent or patent rights of Globaltech Semiconductor. Specifications mentioned in this publication are subject to change without notice. This publication supersedes and replaces all information without express written approval of Globaltech Semiconductor.

CONTACT US

GS Headquarter	
	4F.,No.43-1,Lane11,Sec.6,Minquan E.Rd NeiHu District Taipei City 114, Taiwan (R.O.C)
	886-2-2657-9980
	886-2-2657-3630
	sales_twn@gs-power.com

Wu-Xi Branch	
	No.21 Changjiang Rd., WND, Wuxi, Jiangsu, China (INFO. & TECH. Science Park Building A 210 Room)
	86-510-85217051
	86-510-85211238
	sales_cn@gs-power.com

RD Division	
	824 Bolton Drive Milpitas. CA. 95035
	1-408-457-0587