

GSM2308

60V N-Channel Enhancement Mode MOSFET

Product Description

GSM2308, N-Channel enhancement mode MOSFET, uses Advanced Trench Technology to provide excellent $R_{DS(ON)}$, low gate charge.

These devices are particularly suited for low voltage power management, such as smart phone and notebook computer and other battery powered circuits, and low in-line power loss are needed in commercial industrial surface mount applications.

Features

- 60V/3.6A, $R_{DS(ON)}=130m\Omega@V_{GS}=10V$
- 60V/2.8A, $R_{DS(ON)}=140m\Omega@V_{GS}=4.5V$
- Super high density cell design for extremely low $R_{DS(ON)}$
- Exceptional on-resistance and maximum DC current capability
- SOT-23-3L package design

Applications

- Portable Equipment
- Battery Powered System
- Net Working System

Packages & Pin Assignments

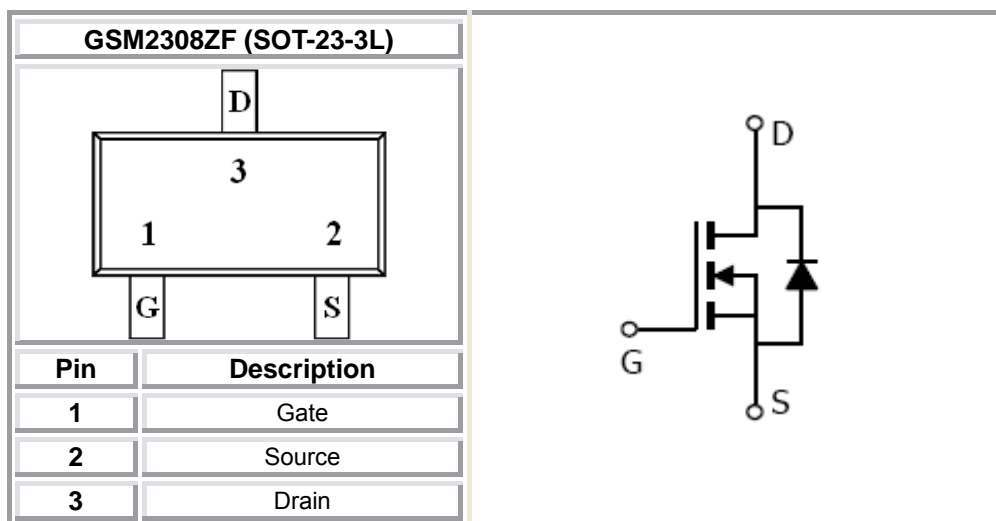

Ordering Information

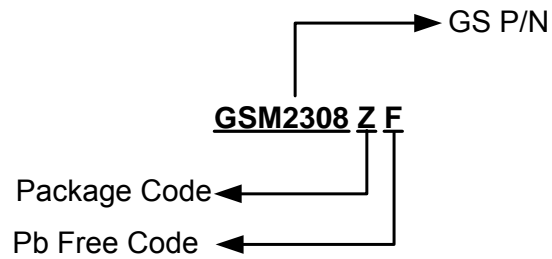

Part Number	Package	Quantity Reel
GSM2308ZF	SOT-23-3L	3000 PCS

Marking Information

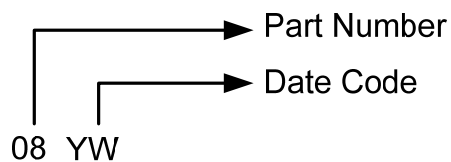

Absolute Maximum Ratings

(T_A=25°C unless otherwise noted)

Symbol	Parameter	Typical	Unit
V _{DSS}	Drain-Source Voltage	60	V
V _{GSS}	Gate -Source Voltage	±20	V
I _D	Continuous Drain Current(T _J =150°C)	T _A =25°C	3.6
		T _A =70°C	2.8
I _{DM}	Pulsed Drain Current	8	A
I _S	Continuous Source Current(Diode Conduction)	1.2	A
P _D	Power Dissipation	T _A =25°C	1.25
		T _A =70°C	0.8
T _J	Operating Junction Temperature	150	°C
T _{STG}	Storage Temperature Range	-55/150	°C
R _{θJA}	Thermal Resistance-Junction to Ambient	120	°C/W

Electrical Characteristics

($T_A=25^\circ\text{C}$ unless otherwise noted)

Symbol	Parameter	Conditions	Min	Typ	Max	Unit
Static						
$V_{(BR)DSS}$	Drain-Source Breakdown Voltage	$V_{GS}=0V, I_D=250\mu A$	60			V
$V_{GS(th)}$	Gate Threshold Voltage	$V_{DS}=V_{GS}, I_D=250\mu A$	0.7		2.5	
I_{GSS}	Gate Leakage Current	$V_{DS}=0V, V_{GS}=\pm 20V$			± 100	nA
I_{DSS}	Zero Gate Voltage Drain Current	$V_{DS}=48V, V_{GS}=0V$			1	uA
		$V_{DS}=48V, V_{GS}=0V, T_J=85^\circ\text{C}$			10	
$I_{D(on)}$	On-State Drain Current	$V_{DS}\geq 5V, V_{GS}=10V$	6			A
$R_{DS(on)}$	Drain-Source On-Resistance	$V_{GS}=10V, I_D=3.6A$		103	130	m Ω
		$V_{GS}=4.5V, I_D=2.8A$		113	140	
g_{FS}	Forward Transconductance	$V_{DS}=15V, I_D=2.0A$		5		S
V_{SD}	Diode Forward Voltage	$I_S=2.5A, V_{GS}=0V$		0.85	1.2	V
Dynamic						
C_{iss}	Input Capacitance	$V_{DS}=30V, V_{GS}=0V, f=1\text{MHz}$		220		pF
C_{oss}	Output Capacitance			20		
C_{rss}	Reverse Transfer Capacitance			10		
Q_g	Total Gate Charge	$V_{DS}=30V, V_{GS}=4.5V, I_D=2.0A$		2.5	3.5	nC
Q_{gs}	Gate-Source Charge			0.8		
Q_{gd}	Gate-Drain Charge			1.0		
$t_{d(on)}$	Turn-On Time	$V_{DD}=30V, R_L=20\Omega, I_D=1.5A, V_{GEN}=10V, R_G=1\Omega$		4	8	ns
t_r				10	20	
$t_{d(off)}$	Turn-Off Time			10	40	
t_f				6	10	

Typical Performance Characteristics

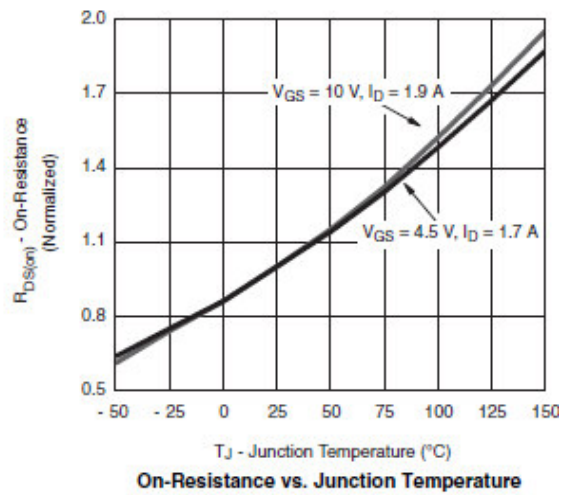
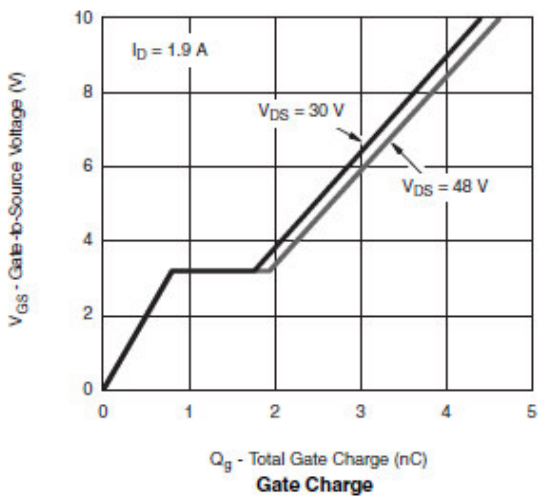
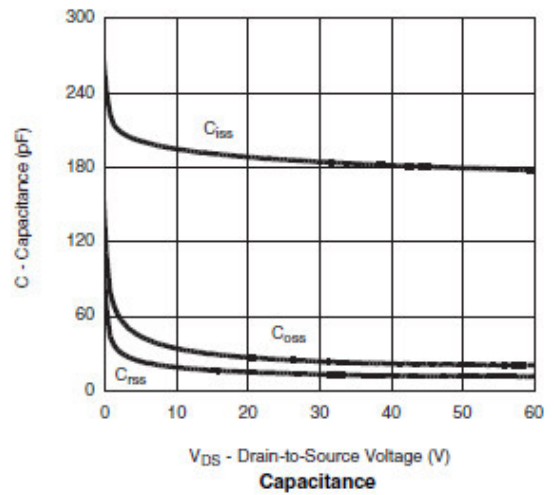
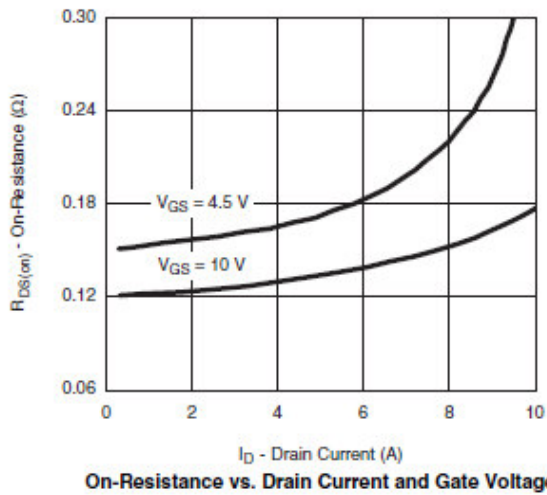
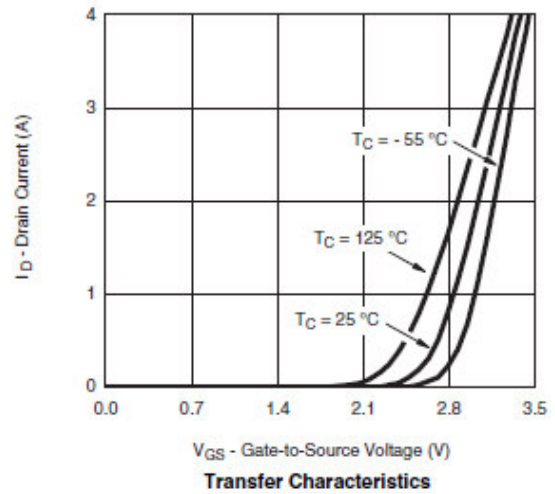
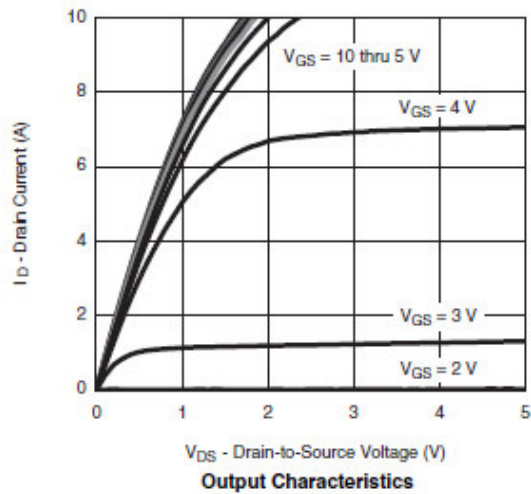

Typical Performance Characteristics (continue)

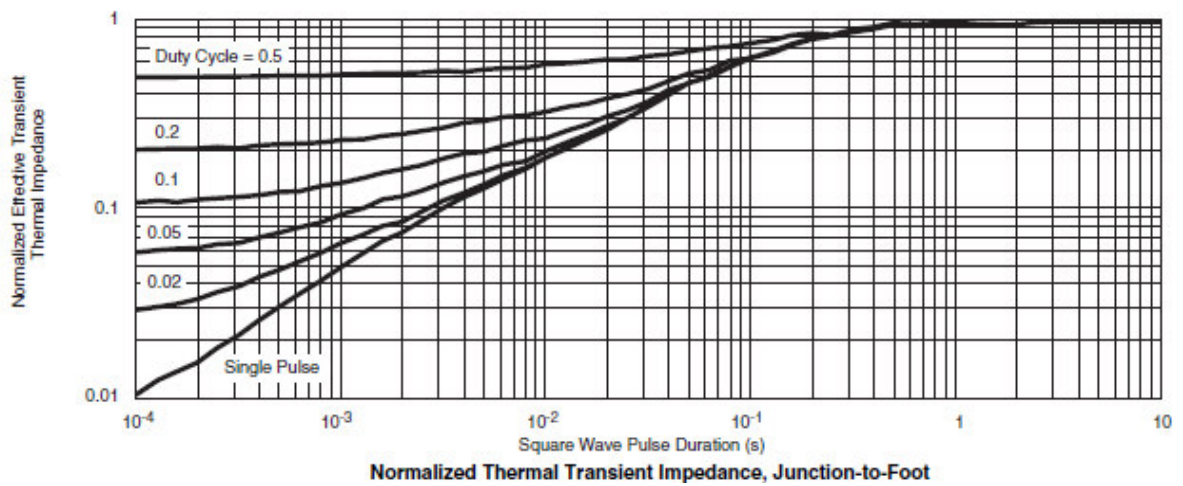
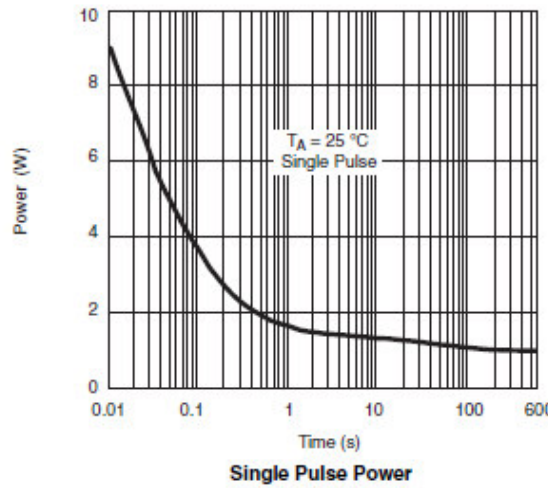
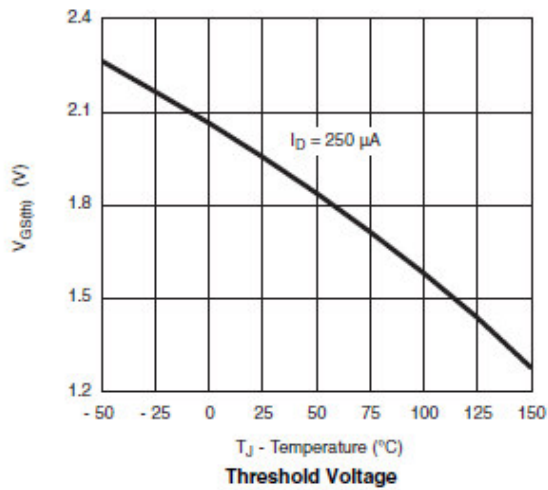
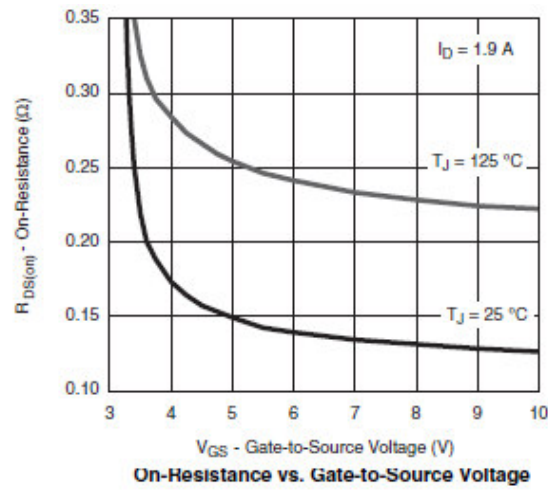
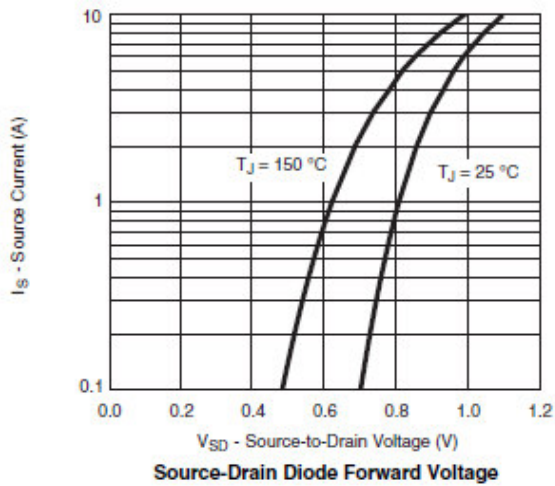

Typical Performance Characteristics (continue)

Gate Charge Test Circuit & Waveform

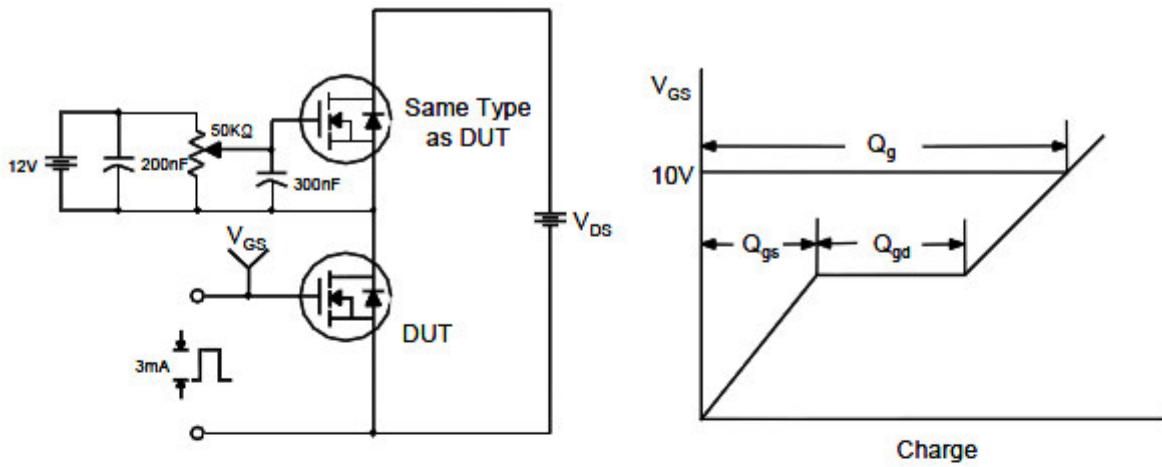

Resistive Switching Test Circuit & Waveforms

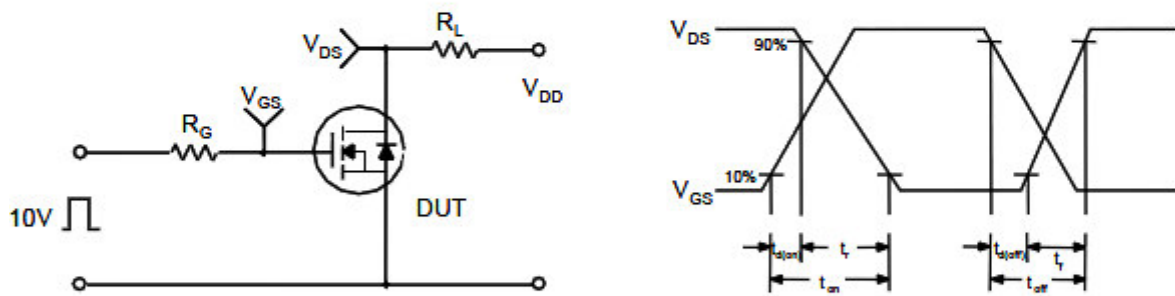

Unclamped Inductive Switching Test Circuit & Waveforms

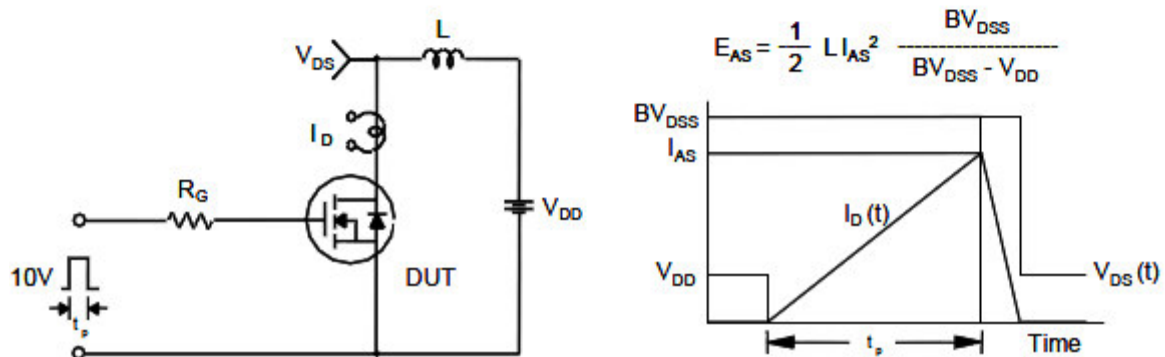

Package Dimension

SOT-23-3L PLASTIC PACKAGE

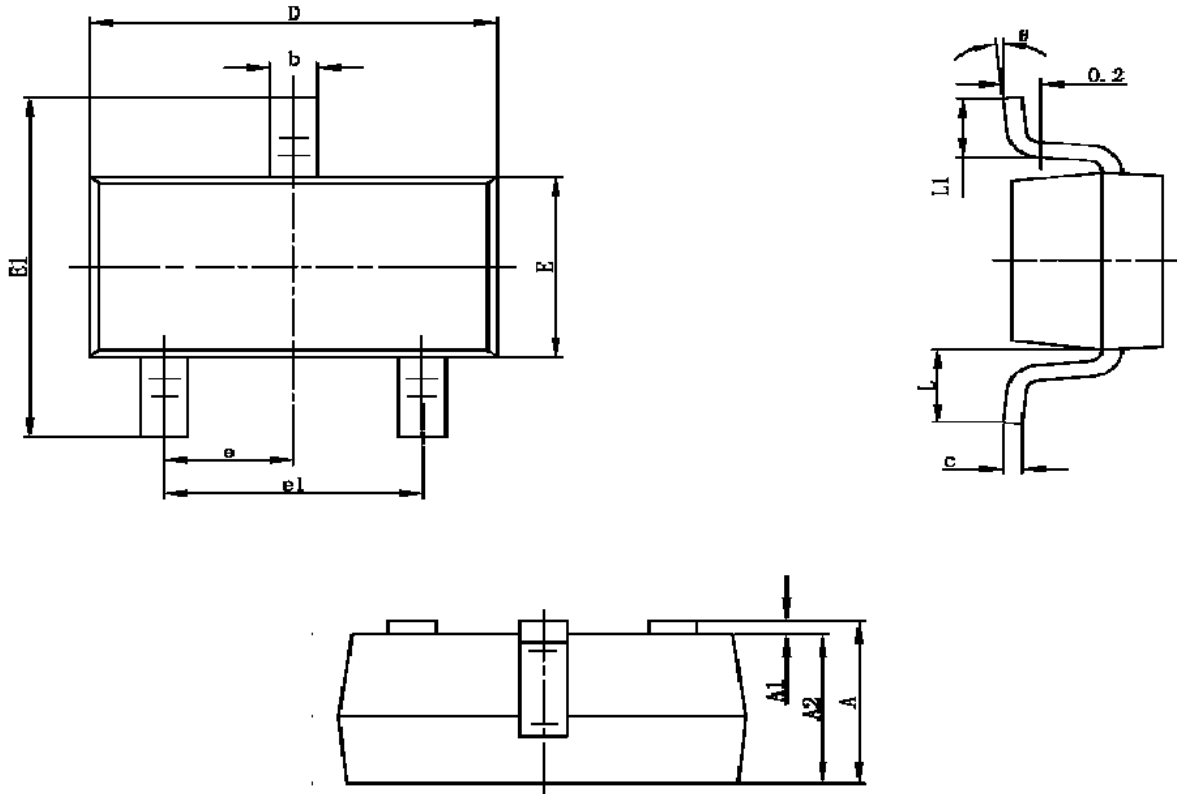



Dimensions				
SYMBOL	Millimeters		Inches	
	MIN	MAX	MIN	MAX
A	1.05	1.25	0.041	0.049
A1	0	0.1	0	0.004
A2	1.05	1.15	0.041	0.045
b	0.3	0.4	0.012	0.016
c	0.1	0.2	0.004	0.008
D	2.82	3.02	0.111	0.119
E	1.5	1.7	0.059	0.067
E1	2.65	2.95	0.104	0.116
e	0.950 (TYP)		0.037 (TYP)	
e1	1.8	2	0.071	0.079
L	0.700 (REF)		0.028 (REF)	
L1	0.3	0.6	0.012	0.024
Q	0°	8°	0°	8°

NOTICE

Information furnished is believed to be accurate and reliable. However Globaltech Semiconductor assumes no responsibility for the consequences of use of such information nor for any infringement of patents or other rights of third parties, which may result from its use. No license is granted by implication or otherwise under any patent or patent rights of Globaltech Semiconductor. Specifications mentioned in this publication are subject to change without notice. This publication supersedes and replaces all information without express written approval of Globaltech Semiconductor.

CONTACT US

GS Headquarter	
	4F.,No.43-1,Lane11,Sec.6,Minquan E.Rd Neihu District Taipei City 114, Taiwan (R.O.C)
	886-2-2657-9980
	886-2-2657-3630
	sales_twn@gs-power.com

Wu-Xi Branch	
	No.21 Changjiang Rd., WND, Wuxi, Jiangsu, China (INFO. &. TECH. Science Park Building A 210 Room)
	86-510-85217051
	86-510-85211238
	sales_cn@gs-power.com

RD Division	
	824 Bolton Drive Milpitas. CA. 95035
	1-408-457-0587