

GSM3406A

30V N-Channel Enhancement Mode MOSFET

Product Description

GSM3406A, N-Channel enhancement mode MOSFET, uses Advanced Trench Technology to provide excellent $R_{DS(ON)}$, low gate charge. These devices are particularly suited for low voltage power management, and low in-line power loss are needed in commercial industrial surface mount applications.

Features

- 30V/2.4A, $R_{DS(ON)}=48m\Omega@V_{GS}=10V$
- 30V/1.8A, $R_{DS(ON)}=58m\Omega@V_{GS}=4.5V$
- Super high density cell design for extremely low $R_{DS(ON)}$
- SOT-23 package design

Applications

- Power Management in Note book
- LED Display
- DC-DC System
- LCD Panel

Packages & Pin Assignments

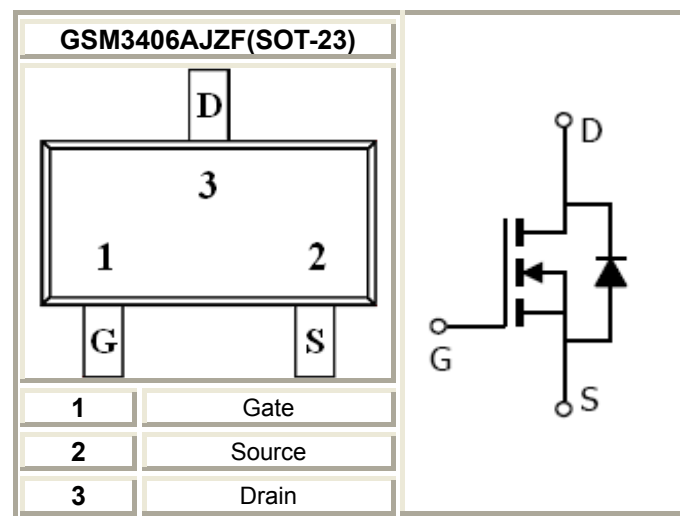

Ordering Information

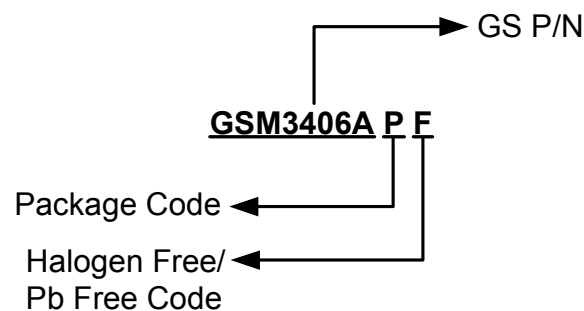

Marking Information

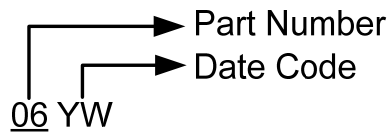

Part Number	Package	Part Marking
GSM3406AJZF	SOT-23	<u>06</u> YW

Absolute Maximum Ratings

(T_A=25°C unless otherwise noted)

Symbol	Parameter	Typical	Unit	
V _{DSS}	Drain-Source Voltage	30	V	
V _{GSS}	Gate –Source Voltage	±20	V	
I _D	Continuous Drain Current(T _J =150°C)	T _A =25°C	2.4	A
		T _A =70°C	1.8	
I _{DM}	Pulsed Drain Current	20	A	
I _S	Continuous Source Current(Diode Conduction)	1.5	A	
P _D	Power Dissipation	T _A =25°C	1.25	W
		T _A =70°C	0.8	
T _J	Operating Junction Temperature	150	°C	
T _{STG}	Storage Temperature Range	-55/150	°C	
R _{θJA}	Thermal Resistance-Junction to Ambient	120	°C/ W	

Electrical Characteristics

($T_A=25^\circ\text{C}$ unless otherwise noted)

Symbol	Parameter	Conditions	Min.	Typ	Max.	Unit	
Static							
$V_{(BR)DSS}$	Drain-Source Breakdown Voltage	$V_{GS}=0V, I_D=250\mu A$	30			V	
$V_{GS(th)}$	Gate Threshold Voltage	$V_{DS}=V_{GS}, I_D=250\mu A$	1.0		2.0		
I_{GSS}	Gate Leakage Current	$V_{DS}=0V, V_{GS}=\pm 20V$			± 100	nA	
I_{DSS}	Zero Gate Voltage Drain Current	$V_{DS}=24V, V_{GS}=0V$			1	uA	
		$V_{DS}=24V, V_{GS}=0V, T_J=85^\circ\text{C}$			30		
$I_{D(on)}$	On-State Drain Current	$V_{DS}\geq 4.5V, V_{GS}=10V$	6			A	
$R_{DS(on)}$	Drain-Source On-Resistance	$V_{GS}=10V, I_D=4.0A$		38	48	m Ω	
		$V_{GS}=4.5V, I_D=3.5A$		48	58		
g_{fs}	Forward Transconductance	$V_{DS}=4.5V, I_D=2.5A$		8		S	
V_{SD}	Diode Forward Voltage	$I_S=1.6A, V_{GS}=0V$		0.8	1.2	V	
Dynamic							
C_{iss}	Input Capacitance	$V_{DS}=15V, V_{GS}=0V, f=1\text{MHz}$		320		pF	
C_{oss}	Output Capacitance			70			
C_{rss}	Reverse Transfer Capacitance			30			
Q_g	Total Gate Charge	$V_{DS}=15V, V_{GS}=10V, I_D\cong 2.6A$		3.0	4.5	nC	
Q_{gs}	Gate-Source Charge			1.6			
Q_{gd}	Gate-Drain Charge			0.6			
$t_{d(on)}$	Turn-On Time	$V_{DD}=15V, R_L=15\Omega, I_D\cong 1.0A, V_{GEN}=10V, R_G=6\Omega$		8	12	ns	
T_r				12	18		
$t_{d(off)}$			Turn-Off Time		15		30
T_f					8		15

Typical Performance Characteristics

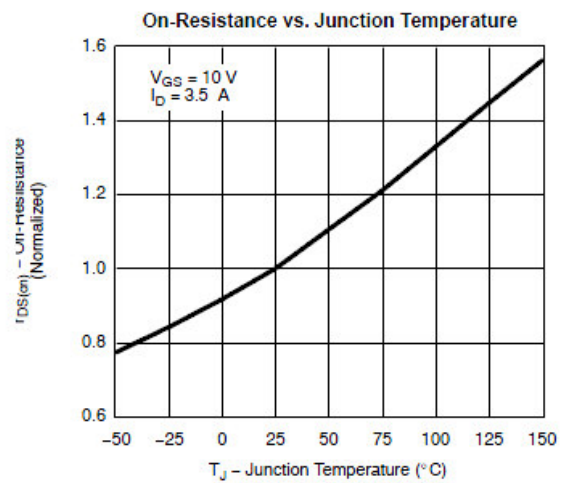
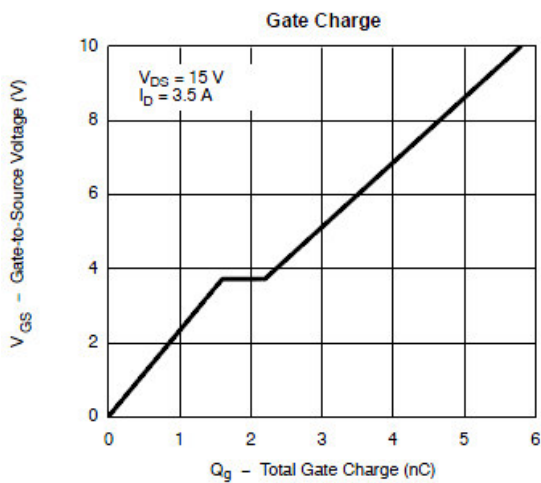
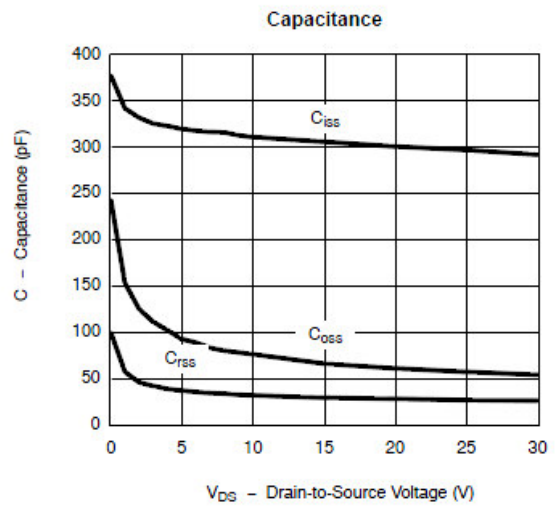
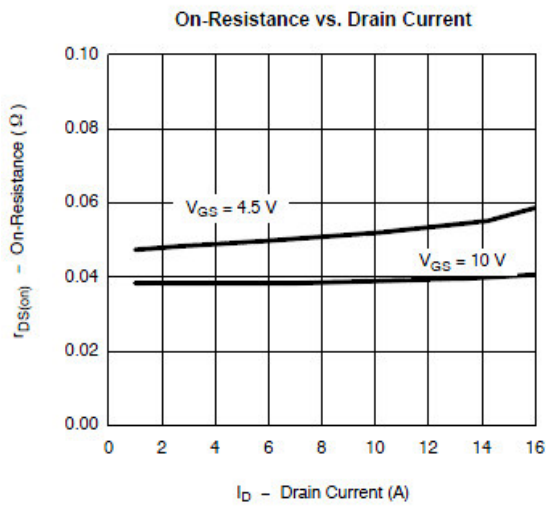
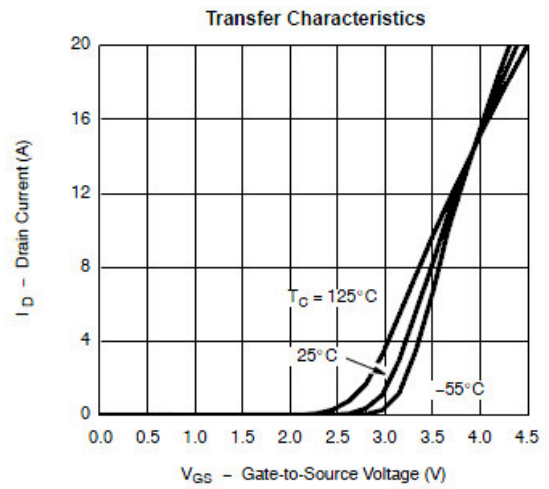
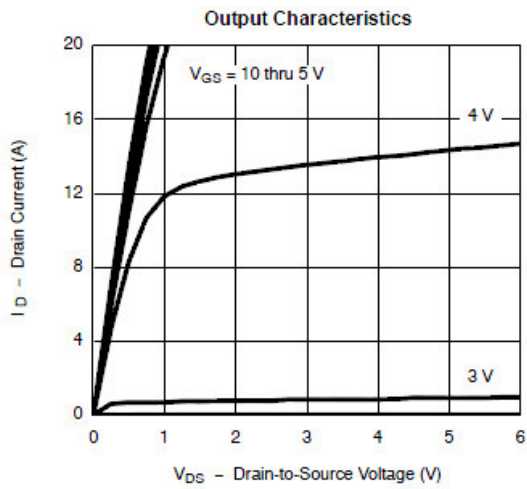

Typical Performance Characteristics (continue)

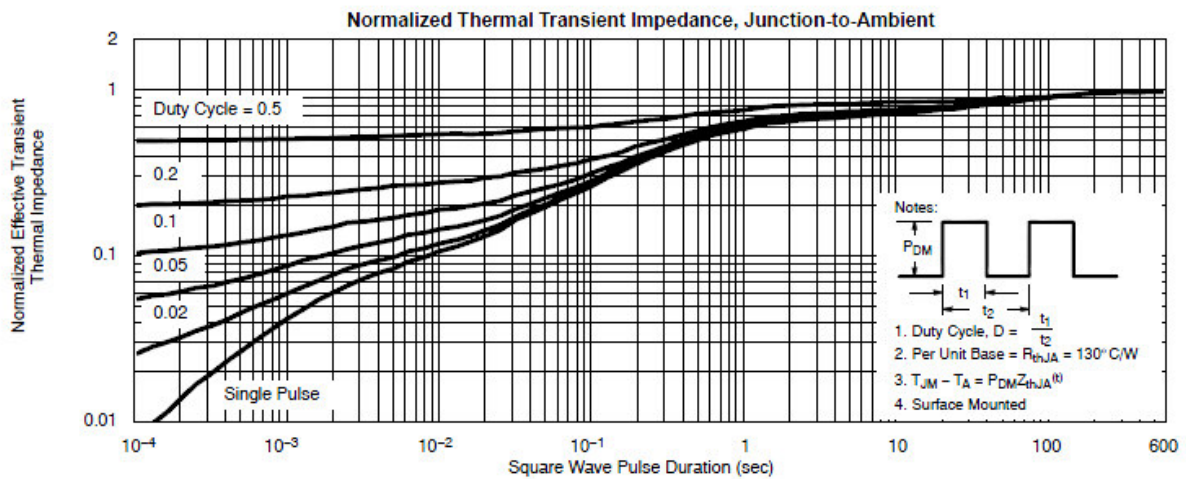
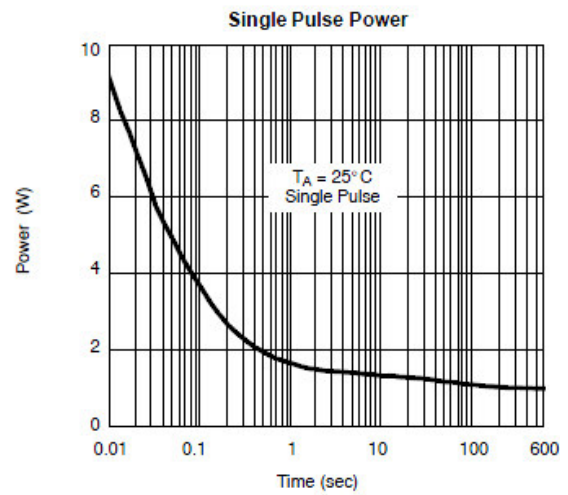
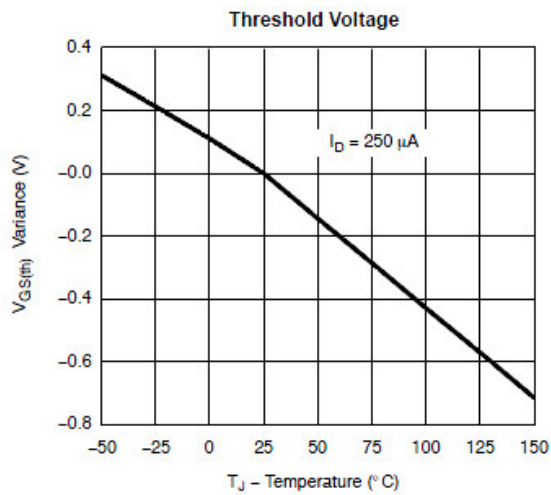
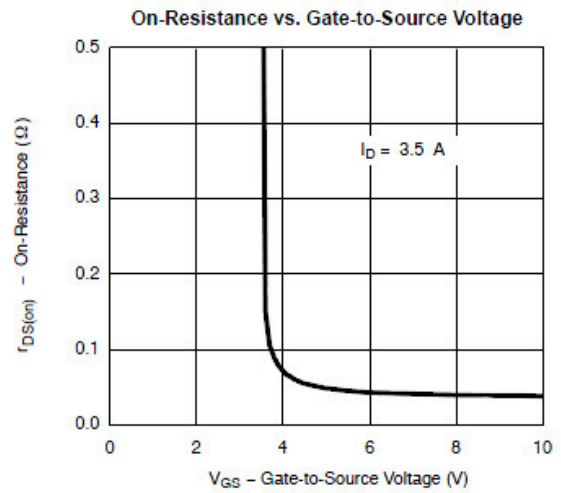
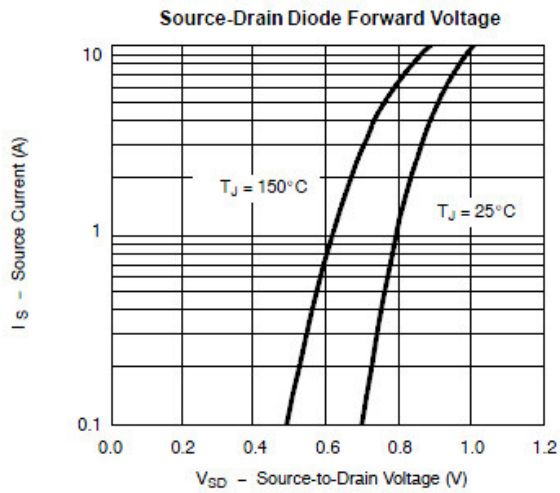

Typical Characteristics

Gate Charge Test Circuit & Waveform

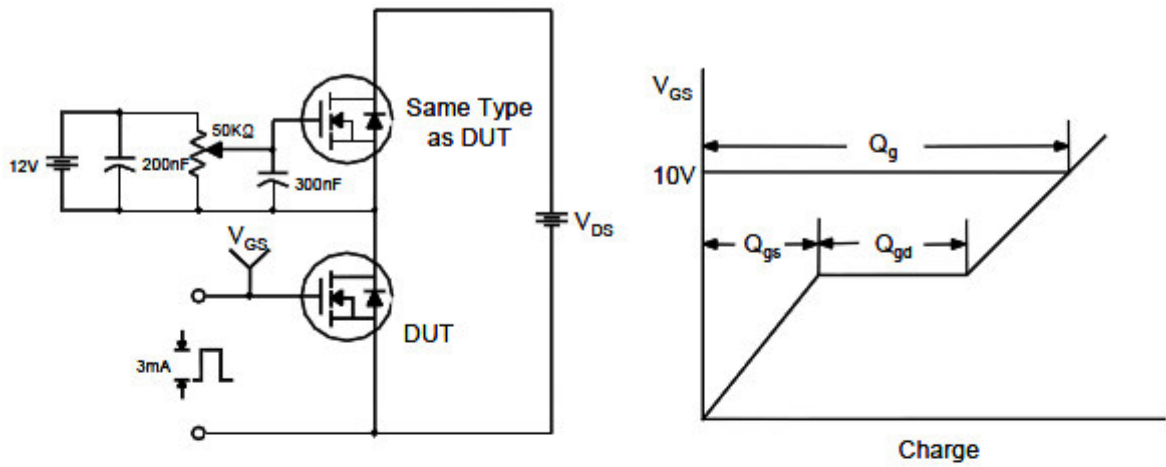

Resistive Switching Test Circuit & Waveforms

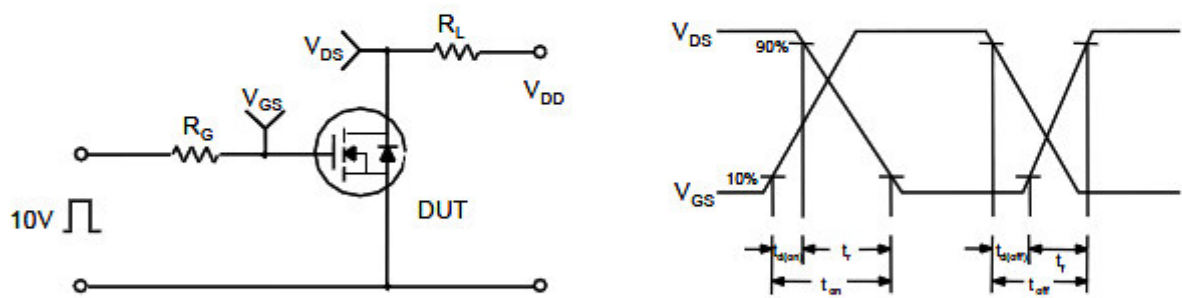

Unclamped Inductive Switching Test Circuit & Waveforms

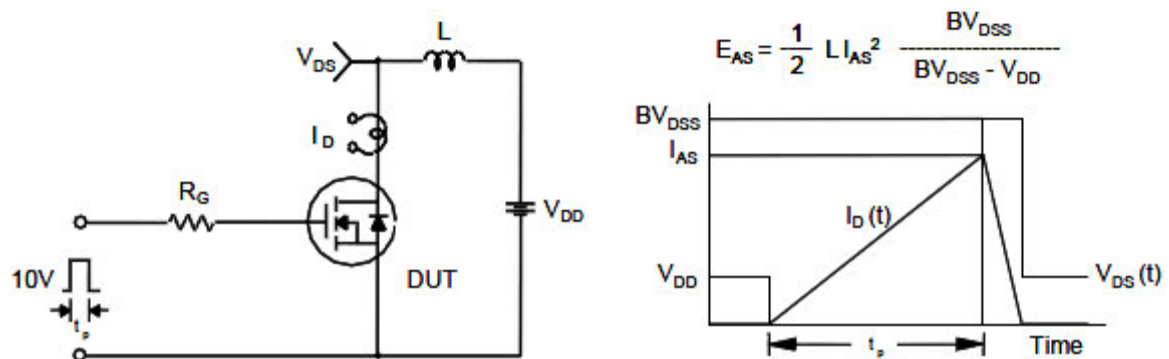

Package Dimension

SOT-23

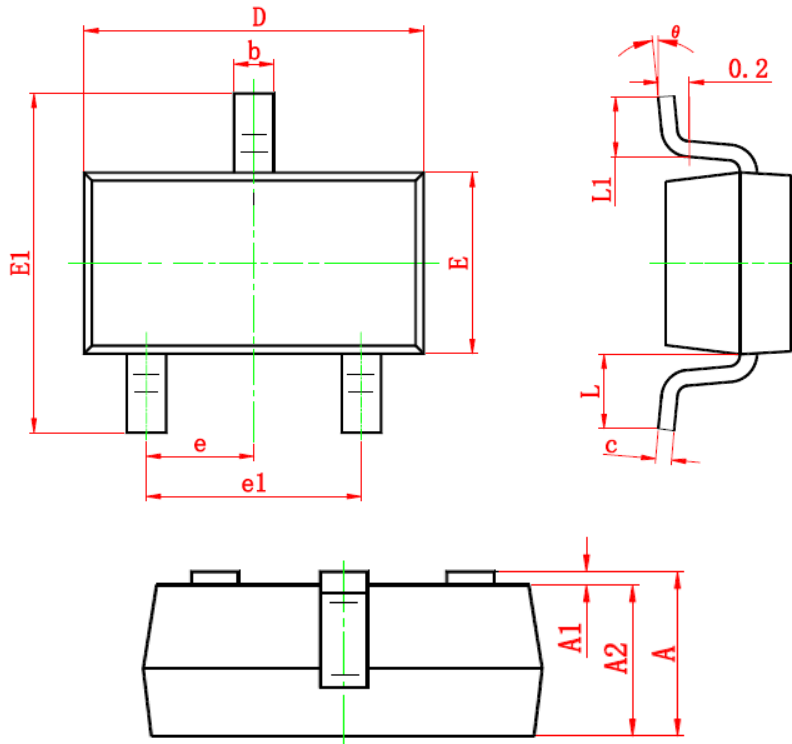









Dimensions				
Symbol	Millimeters		Inches	
	Min	Max	Min	Max
A	0.900	1.200	0.035	0.043
A1	0.000	0.100	0.000	0.004
A2	0.900	1.100	0.035	0.039
b	0.300	0.500	0.012	0.020
c	0.080	0.150	0.003	0.006
D	2.800	3.000	0.110	0.118
E	1.200	1.400	0.047	0.055
E1	2.250	2.550	0.089	0.100
e	0.950 TYP		0.037 TYP	
e1	1.800	2.000	0.071	0.079
L	0.550 REF		0.022 REF	
L1	0.300	0.500	0.012	0.020
θ	0°	8°	0°	6°



NOTICE

Information furnished is believed to be accurate and reliable. However Globaltech Semiconductor assumes no responsibility for the consequences of use of such information nor for any infringement of patents or other rights of third parties, which may result from its use. No license is granted by implication or otherwise under any patent or patent rights of Globaltech Semiconductor. Specifications mentioned in this publication are subject to change without notice. This publication supersedes and replaces all information without express written approval of Globaltech Semiconductor.

CONTACT US

GS Headquarter	
	4F.,No.43-1,Lane11,Sec.6,Minquan E.Rd Neihu District Taipei City 114, Taiwan (R.O.C)
	886-2-2657-9980
	886-2-2657-3630
	sales_twn@gs-power.com

Wu-Xi Branch	
	No.21 Changjiang Rd., WND, Wuxi, Jiangsu, China (INFO. &. TECH. Science Park Building A 210 Room)
	86-510-85217051
	86-510-85211238
	sales_cn@gs-power.com

RD Division	
	824 Bolton Drive Milpitas. CA. 95035
	1-408-457-0587