



Micro Commercial Components



Micro Commercial Components
20736 Marilla Street Chatsworth
CA 91311
Phone: (818) 701-4933
Fax: (818) 701-4939

RB420DS

Features

- Lead Free Finish/RoHS Compliant ("P" Suffix designates RoHS Compliant. See ordering information)
Small surface mounting type
Low reverse current and low forward voltage
High reliability
Marking:D3B

Maximum Ratings

Table with 4 columns: Parameter, Symbol, Value, Unit. Rows include Peak Reverse Voltage, DC Reverse Voltage, Mean Rectifying Current, Peak Forward Surge Current, Junction Temperature, and Storage Temperature.

Electrical Characteristics @ 25°C Unless Otherwise Specified

Table with 6 columns: Parameter, Symbol, Min., Typ., Max., Unit. Rows include Forward Voltage @ IF=10mA, Reverse Current @ VR=10V, and Capacitance Between Terminals @ VR=10V, f=1MHz.

0.1 Amp Schottky Barrier Rectifier
40 Volts

SOT-23

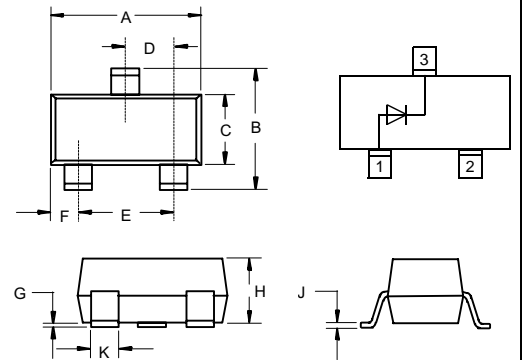
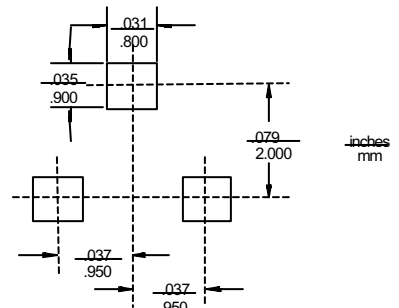

Table titled 'DIMENSIONS' with columns for DIM, INCHES (MIN, MAX), MM (MIN, MAX), and NOTE. It lists dimensions A through K.

Suggested Solder Pad Layout



RB420DS

Typical Characteristics

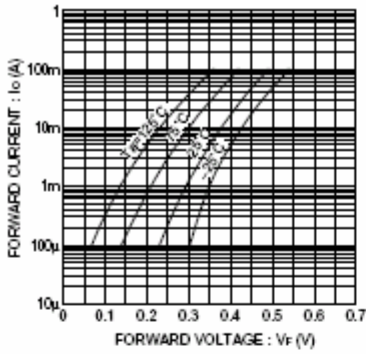

Fig.1 Forward characteristics

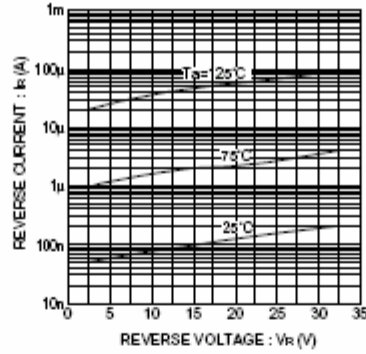

Fig.2 Reverse characteristics

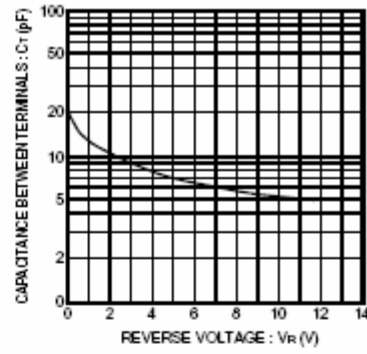

Fig.3 Capacitance between terminals characteristics

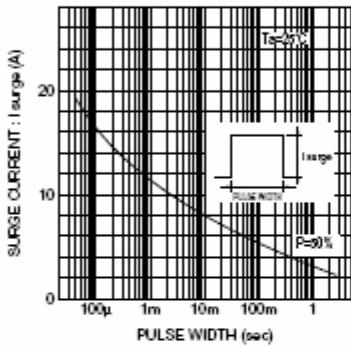

Fig.4 Surge current characteristics

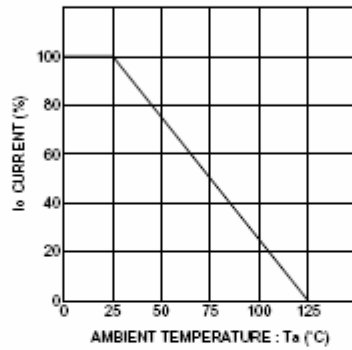

Fig.5 Derating curve (mounting on glass epoxy PCBs)



Micro Commercial Components

Ordering Information :

Device	Packing
Part Number-TP	Tape&Reel: 3Kpcs/Reel

*****IMPORTANT NOTICE*****

Micro Commercial Components Corp. reserves the right to make changes without further notice to any product herein to make corrections, modifications , enhancements , improvements , or other changes . **Micro Commercial Components Corp .** does not assume any liability arising out of the application or use of any product described herein; neither does it convey any license under its patent rights ,nor the rights of others . The user of products in such applications shall assume all risks of such use and will agree to hold **Micro Commercial Components Corp .** and all the companies whose products are represented on our website, harmless against all damages.

*****LIFE SUPPORT*****

MCC's products are not authorized for use as critical components in life support devices or systems without the express written approval of Micro Commercial Components Corporation.

*****CUSTOMER AWARENESS*****

Counterfeiting of semiconductor parts is a growing problem in the industry. Micro Commercial Components (MCC) is taking strong measures to protect ourselves and our customers from the proliferation of counterfeit parts. MCC strongly encourages customers to purchase MCC parts either directly from MCC or from Authorized MCC Distributors who are listed by country on our web page cited below. Products customers buy either from MCC directly or from Authorized MCC Distributors are genuine parts, have full traceability, meet MCC's quality standards for handling and storage. **MCC will not provide any warranty coverage or other assistance for parts bought from Unauthorized Sources.** MCC is committed to combat this global problem and encourage our customers to do their part in stopping this practice by buying direct or from authorized distributors.