



Micro Commercial Components



Micro Commercial Components  
 20736 Marilla Street Chatsworth  
 CA 91311  
 Phone: (818) 701-4933  
 Fax: (818) 701-4939

# FR3AB THRU FR3MB

## Features

- Lead Free Finish/Rohs Compliant (Note1) ("P" Suffix designates Compliant. See ordering information)
- Epoxy meets UL 94 V-0 flammability rating
- Moisture Sensitivity Level 1
- Easy Pick And Place
- High Temp Soldering: 260°C for 10 Seconds At Terminals\
- Fast Recovery Times For High Efficiency

## Maximum Ratings

- Operating Temperature: -55°C to +150°C
- Storage Temperature: -55°C to +150°C
- Maximum Thermal Resistance; 10°C/W Junction To Lead

| MCC Catalog Number | Device Marking | Maximum Recurrent Peak Reverse Voltage | Maximum RMS Voltage | Maximum DC Blocking Voltage |
|--------------------|----------------|--|---------------------|-----------------------------|
| FR3AB              | FR3AB          | 50V                                    | 35V                 | 50V                         |
| FR3BB              | FR3BB          | 100V                                   | 70V                 | 100V                        |
| FR3DB              | FR3DB          | 200V                                   | 140V                | 200V                        |
| FR3GB              | FR3GB          | 400V                                   | 280V                | 400V                        |
| FR3JB              | FR3JB          | 600V                                   | 420V                | 600V                        |
| FR3KB              | FR3KB          | 800V                                   | 560V                | 800V                        |
| FR3MB              | FR3MB          | 1000V                                  | 700V                | 1000V                       |

## Electrical Characteristics @ 25°C Unless Otherwise Specified

|   |             |                                       |   |
|---|-------------|---------------------------------------|---|
| Average Forward Current                                 | $I_{F(AV)}$ | 3.0A                                  | $T_J = 120^\circ\text{C}$                             |
| Peak Forward Surge Current                              | $I_{FSM}$   | 100A                                  | 8.3ms, half sine                                      |
| Maximum Instantaneous Forward Voltage                   | $V_F$       | 1.30V                                 | $I_{FM} = 3.0A$ ;<br>$T_J = 25^\circ\text{C}^*$       |
| Maximum DC Reverse Current At Rated DC Blocking Voltage | $I_R$       | 10 $\mu\text{A}$<br>250 $\mu\text{A}$ | $T_J = 25^\circ\text{C}$<br>$T_J = 100^\circ\text{C}$ |
| Maximum Reverse Recovery Time                           | $T_{rr}$    | 150ns<br>250ns<br>500ns               | $I_F = 0.5A$ , $I_R = 1.0A$ ,<br>$I_{rr} = 0.25A$     |
| Typical Junction Capacitance                            | $C_J$       | 80pF                                  | Measured at<br>1.0MHz, $V_R = 4.0V$                   |

\*Pulse test: Pulse width 200  $\mu\text{sec}$ , Duty cycle 2%

Note: 1. High Temperature Solder Exemptions Applied, see EU Directive Annex 7.

## 3 Amp Fast Recovery Silicon Rectifier 50 to 1000 Volts

### DO-214AA (SMB) (LEAD FRAME)

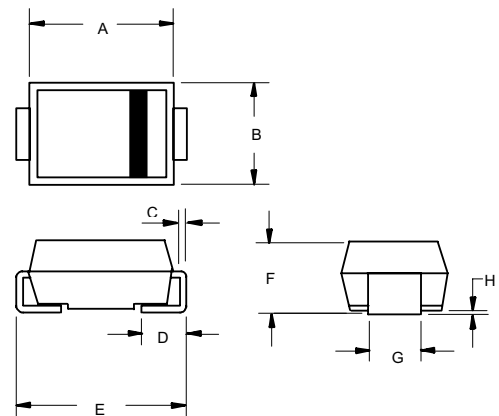

| DIM | DIMENSIONS |      |      |       | NOTE |
|-----|------------|------|------|-------|------|
|     | INCHES     |      | MM   |       |      |
| A   | .160       | .185 | 4.06 | 4.70  |      |
| B   | .130       | .155 | 3.30 | 3.94  |      |
| C   | .006       | .012 | 0.15 | 0.31  |      |
| D   | .030       | .060 | 0.76 | 1.52  |      |
| E   | .200       | .220 | 5.08 | 5.59  |      |
| F   | .079       | .103 | 2.01 | 2.62  |      |
| G   | .075       | .087 | 1.91 | 2.21  |      |
| H   | .002       | .008 | 0.05 | 0.203 |      |

### SUGGESTED SOLDER PAD LAYOUT

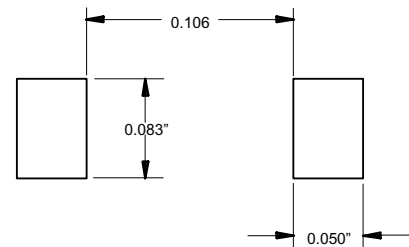

# FR3AB thru FR3MB

Figure 1  
Typical Forward Characteristics

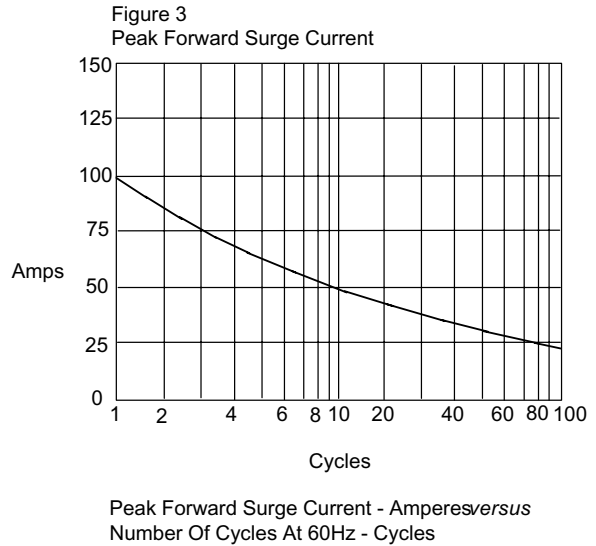
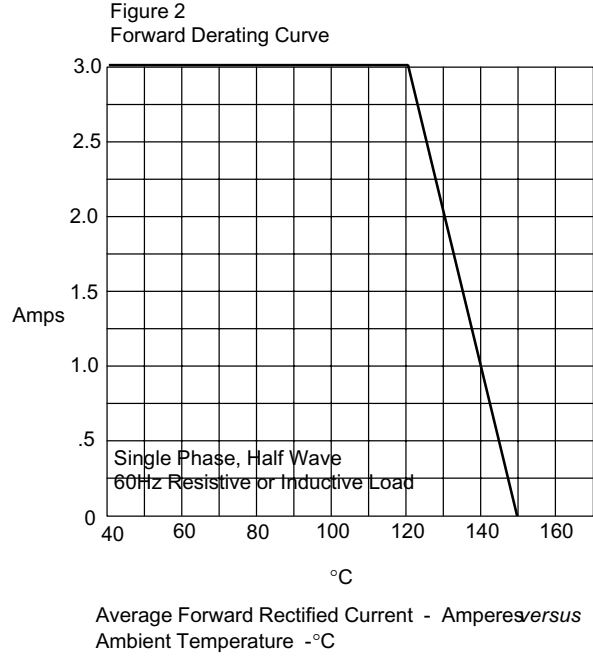
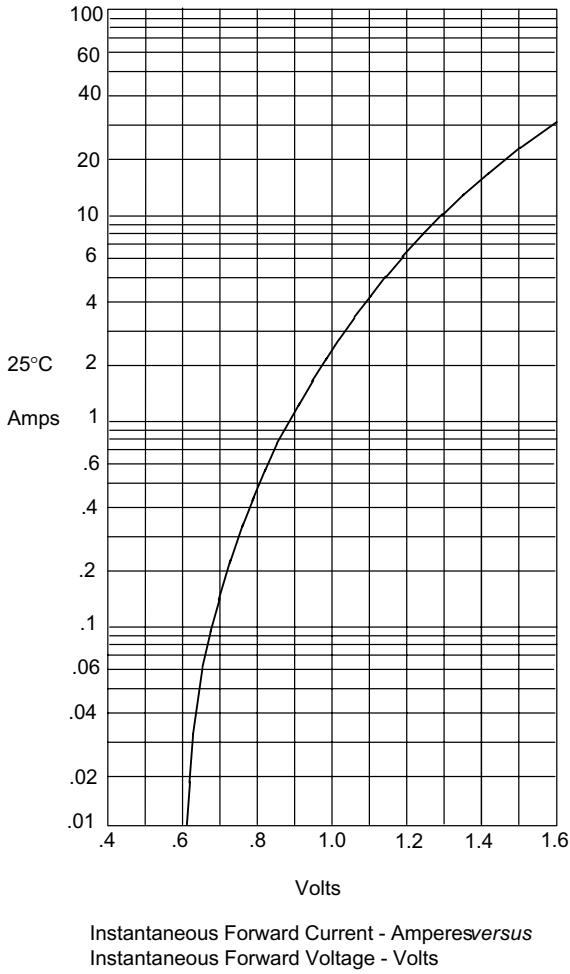
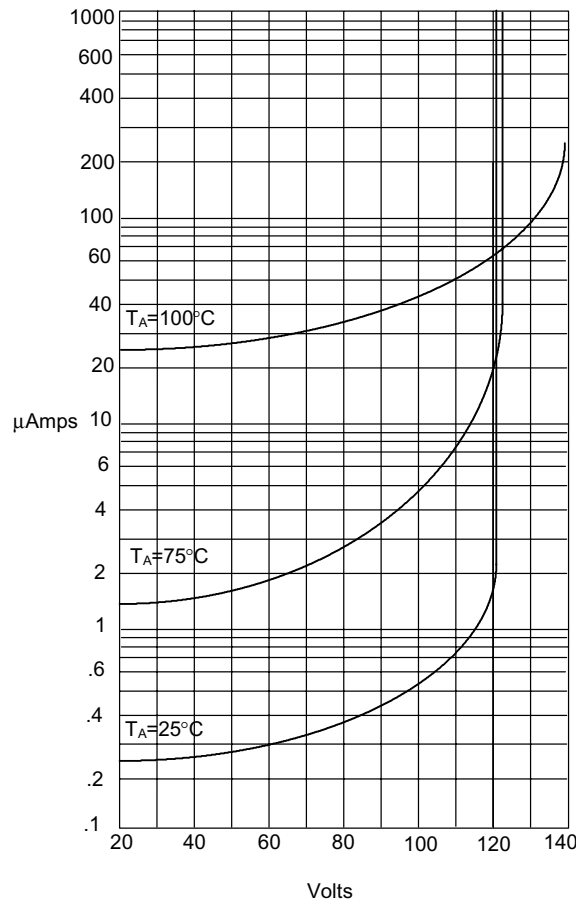
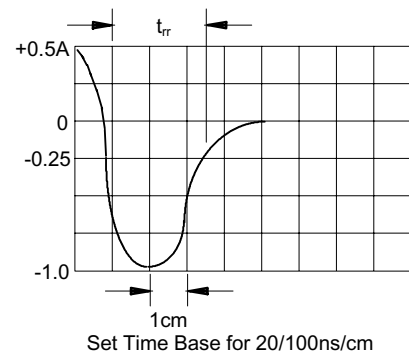
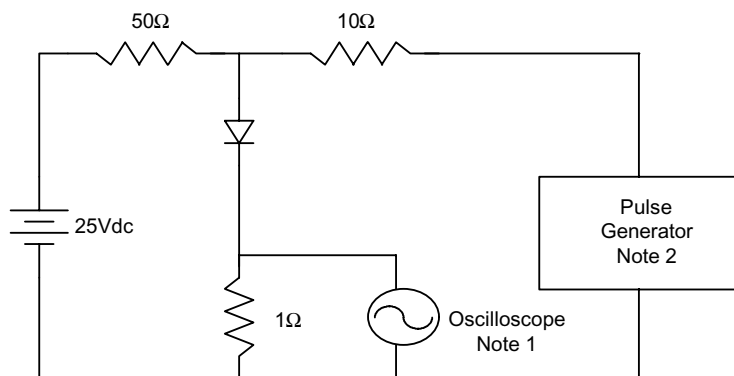

Figure 4  
Typical Reverse Characteristics



Instantaneous Reverse Leakage Current - MicroAmperes versus  
Percent Of Rated Peak Reverse Voltage - Volts

Figure 5  
Reverse Recovery Time Characteristic And Test Circuit Diagram



- Notes:
1. Rise Time = 7ns max.  
Input impedance = 1 megohm, 22pF
  2. Rise Time = 10ns max.  
Source impedance = 50 ohms
  3. Resistors are non-inductive



Micro Commercial Components

### Ordering Information :

| Device         | Packing               |
|----------------|-----------------------|
| Part Number-TP | Tape&Reel: 3Kpcs/Reel |

**\*\*\*IMPORTANT NOTICE\*\*\***

**Micro Commercial Components Corp.** reserves the right to make changes without further notice to any product herein to make corrections, modifications , enhancements , improvements , or other changes . **Micro Commercial Components Corp .** does not assume any liability arising out of the application or use of any product described herein; neither does it convey any license under its patent rights ,nor the rights of others . The user of products in such applications shall assume all risks of such use and will agree to hold **Micro Commercial Components Corp .** and all the companies whose products are represented on our website, harmless against all damages.

**\*\*\*LIFE SUPPORT\*\*\***

MCC's products are not authorized for use as critical components in life support devices or systems without the express written approval of Micro Commercial Components Corporation.

**\*\*\*CUSTOMER AWARENESS\*\*\***

Counterfeiting of semiconductor parts is a growing problem in the industry. Micro Commercial Components (MCC) is taking strong measures to protect ourselves and our customers from the proliferation of counterfeit parts. MCC strongly encourages customers to purchase MCC parts either directly from MCC or from Authorized MCC Distributors who are listed by country on our web page cited below. Products customers buy either from MCC directly or from Authorized MCC Distributors are genuine parts, have full traceability, meet MCC's quality standards for handling and storage. **MCC will not provide any warranty coverage or other assistance for parts bought from Unauthorized Sources.** MCC is committed to combat this global problem and encourage our customers to do their part in stopping this practice by buying direct or from authorized distributors.

[www.mccsemi.com](http://www.mccsemi.com)